

Item	Part No	Description
1	120.113858	Potentiometer 10k
2	120/112125	Knob,Potentiometer 10k
3	120/112183	Protection,rectifier
4	120/114306	Wire feed PCB
5	120/120302	Cable 16mmq 1.8m
6	120.113533	Potentiometer
7	120.322900	Knob for switch
8	120/122329	Thermostat
10	120/122707	Light
11	120/122035	Electro-valve
13	120/122567	Switch (SCH 0407/6629)
14	120/112227	Rectifier
15	120/132191	Mains cable
16	120/152054	Blade,fan
17	120/152110	Motor,fan
18	120/153007	Wire feed motor
20	120.169296	Transformer 230v
21	120/164145	Reactance
22	120/232105	Counter roller
23	120/312137	Knob
24	120/322081	Spindle, sleeve/spacer type
25	120/322112	Bushing, cable
26	120/322126	Casing, feeder roller shaft
27	120/322127	Casing, torch fixing
28	120/322128	Bracket, counter roller
29	120/322180	Spacer collar
30	120/322200	Wheel (fixed)
31	120/322246	Wheel
32	120/322248	Handle support block - right
33	120/322249	Handle support block - left
34	120/422257	Knob, counter roller tension
35	120/452022	Spring, counter roller tension
36	120/422817	Bracket, axle
37	120/422969	Bracket, castor
38	120/432102	Bull nosed adaptor (not shown)
39	120/452057	Spring
40	120/312103	Handle
41	120/644078	Diaphragm
42	120/644606	Bracket (bottle)
43	120.644757	Back panel
44	120.649245	Front panel
45	120/650025	Cover
46	120/650428	Bottom
47	120/655764	Side panel
48	120/655765	Door
49	120/681092	Axle, wheel
50	120/712030	Clamp, earth
51	120/722019	Feed roller 0.6 - 0.8
52	REG/MT	Regulator (2 gauges) not shown
53	120/723051	Connection, torch
54	120/742180	TORCH
55	120/990097	Guide hose
56	120/990264	Spindle Kit
57	120/990257	Gear set

PARTS IN BOLD TYPE INDICATE ASSEMBLIES. FOR A FURTHER BREAKDOWN OF COMPONENTS CONTACT YOUR LOCAL SEALEY DEALER (N/S = NOT SHOWN)

NOTE: It is our policy to continually improve products and as such we reserve the right to alter data, specifications and component parts without prior notice.
IMPORTANT: No liability is accepted for incorrect use of product. **WARRANTY:** Guarantee is 12 months from purchase date, proof of which will be required for any claim. **INFORMATION:** Call us for a copy of our latest catalogue on 01284 757525 and leave your full name and address including your postcode.

TORCH COMPLETE 120/742180

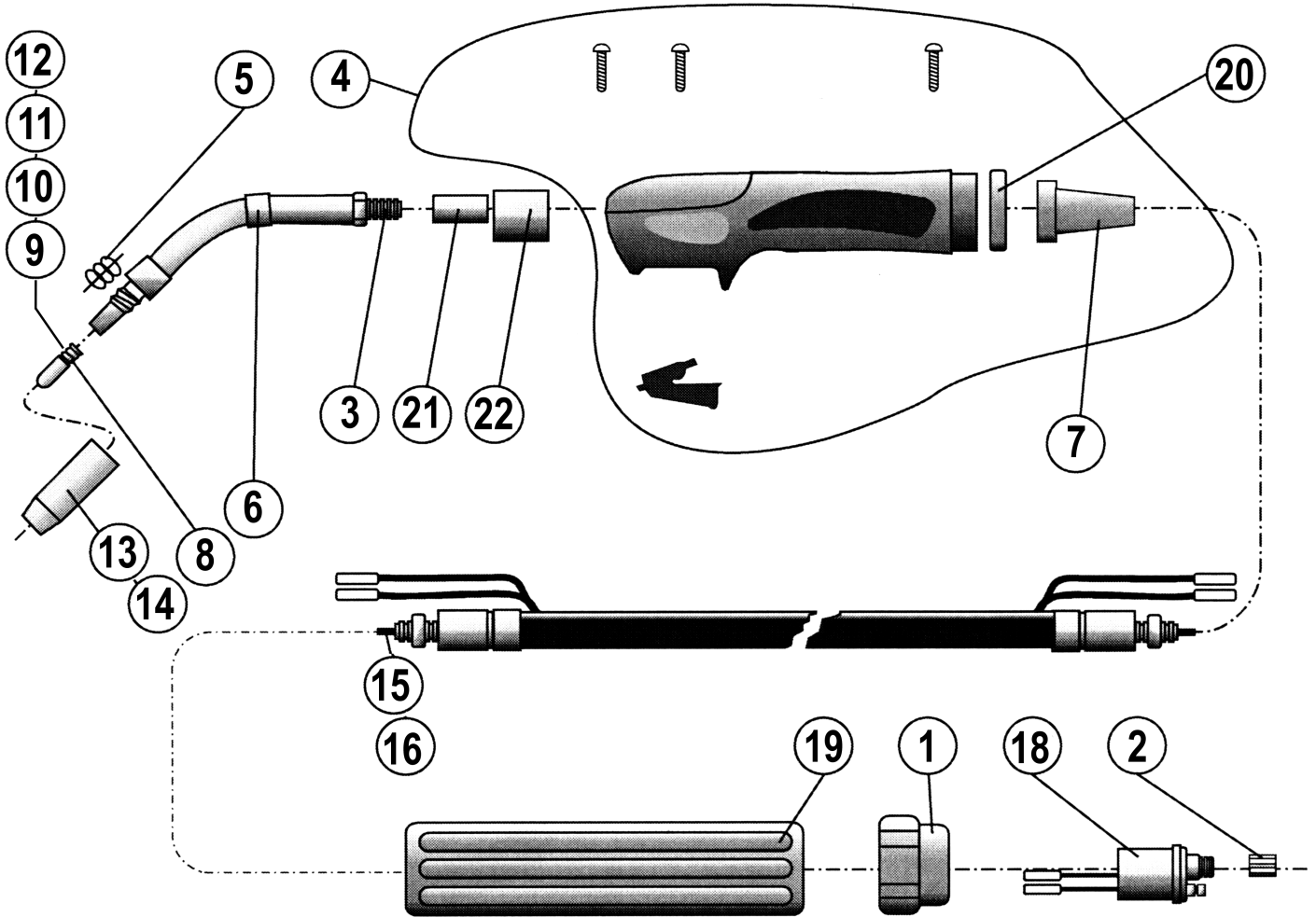

ISSUE NO. 3
 ISSUE DATE 18/09/03

Item	Part No	Description	Item	Part No	Description
1	120/722007	Ring nut	13	120/722149	Nozzle, Cylinder TB14 - 15
2	120/722013	Nut, Liner retainer	14	120/722423	Nozzle, Conical TB14 - 15 (AF1)
3	120.722305	Lance and Diffuser TB15	15	120/722437	Liner,T, 0.6 - 0.8mm 3mt Steel
4	120/742170	Handle complete	16	120/722689	Liner,T, 1.0 - 1.2mm 3mt Steel
5	120/722319	Spring for nozzle	18	120/722441	Termination connector
6	120/722326	Insulation, diffuser	19	120/742175	Gun plug housing
7	120/742172	Torch holder	20	120/722171	Ring nut
8	120/722415	Contact tip 0.6mm (AF1)	21	120/722325	Front torch part
9	120/722416	Contact tip 0.8mm(AF1)	22	120/722693	Insulation Block, Torch part
10	120/722552	Contact tip 1.0mm ALLY (AF1)			
11	120/722553	Contact tip 1.2mm ALLY (AF1)			
12	120/722556	Contact tip 0.8mm ALLY			

NOTE: It is our policy to continually improve products and as such we reserve the right to alter data, specifications and component parts without prior notice.
IMPORTANT: No liability is accepted for incorrect use of product. **WARRANTY:** Guarantee is 12 months from purchase date, proof of which will be required for any claim. **INFORMATION:** Call us for a copy of our latest catalogue on 01284 757525 and leave your full name and address including your postcode.

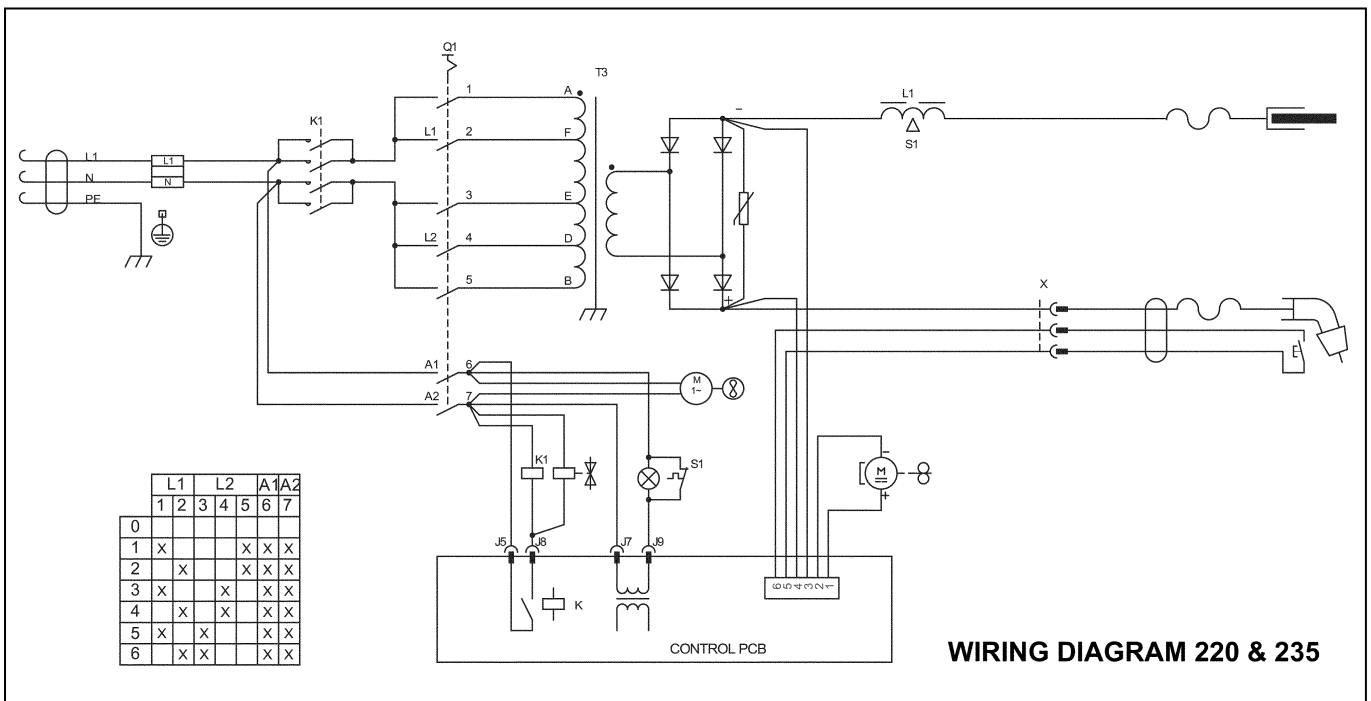
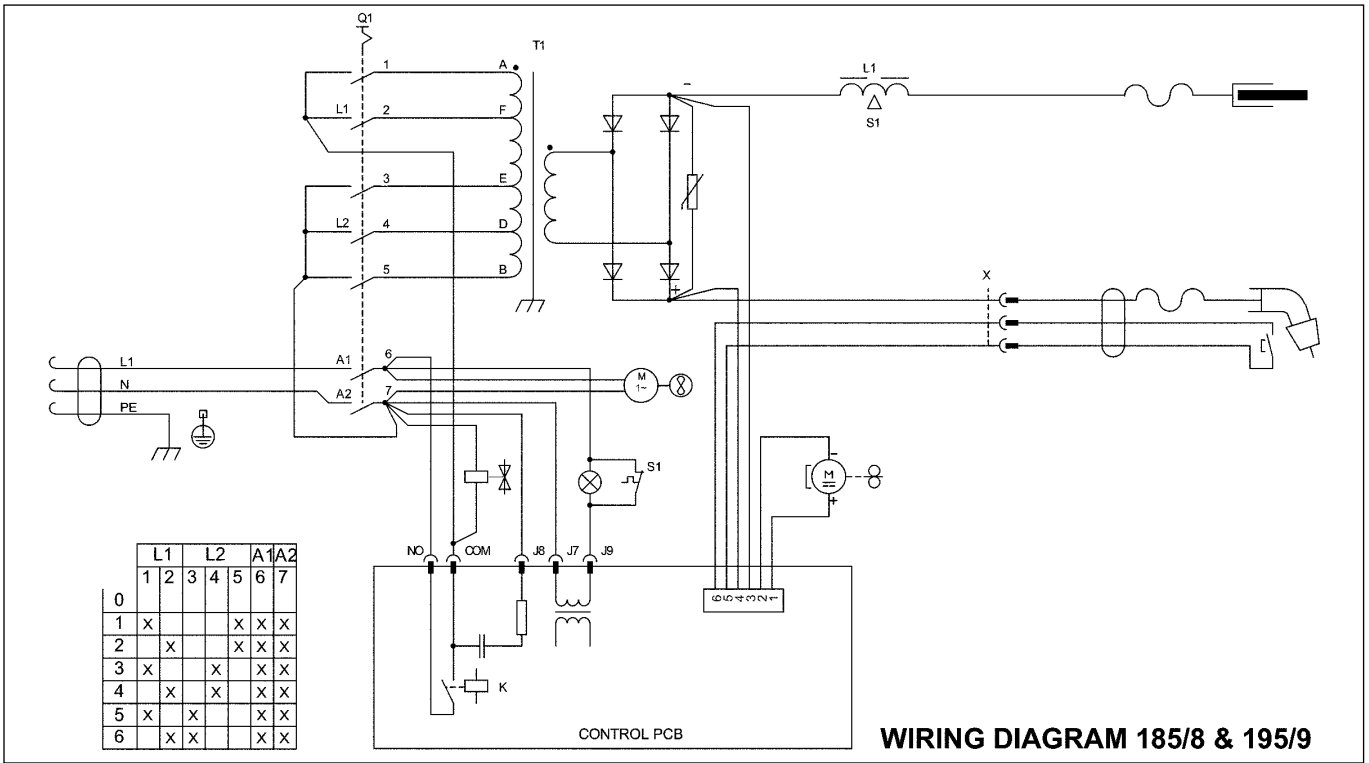

Declaration of Conformity We, the sole importer into the UK, declare that the products listed below are in conformity with the following EEC standards and directives.

MODELS:
Supermig185/8.V3, Supermig195/9.V3
Supermig220.V4, Supermig235.V3

Low Voltage Directive (S.I. 1994/3260) 73/23/EEC
 EMC Directive (S.I. 1992/2372 & Amendments).
 89/336/EEC



The construction files for these products are held by the Manufacturer and may be inspected by a national authority upon request to Jack Sealey Ltd

Signed by Mark Sweetman

22nd May 2002

For Jack Sealey Ltd. Sole importer into the UK of Sealey as Power Welders

NOTE: It is our policy to continually improve products and as such we reserve the right to alter data, specifications and component parts without prior notice.

IMPORTANT: No liability is accepted for incorrect use of this equipment

WARRANTY: Guarantee is 12 months from purchase date, proof of which will be required for any claim.

INFORMATION: Call us for a copy of our latest catalogue on 01284 757525 and leave your full name and address including your postcode.



Sole UK Distributor
 Sealey Group,
 Bury St. Edmunds, Suffolk.

01284 757500
 01284 703534

www.sealey.co.uk
 sales@sealey.co.uk