

Thank you for purchasing a Sealey product. Manufactured to a high standard this product will, if used according to these instructions and properly maintained, give you years of trouble free performance.

 **IMPORTANT: PLEASE READ THESE INSTRUCTIONS CAREFULLY. NOTE THE SAFE OPERATIONAL REQUIREMENTS, WARNINGS AND CAUTIONS. USE THIS PRODUCT CORRECTLY AND WITH CARE FOR THE PURPOSE FOR WHICH IT IS INTENDED. FAILURE TO DO SO MAY CAUSE DAMAGE AND/OR PERSONAL INJURY AND WILL INVALIDATE THE WARRANTY. PLEASE KEEP INSTRUCTIONS SAFE FOR FUTURE USE.**

Table of Contents

1. Safety Instructions	2
1.1. Work Area Safety	2
1.2. Electrical Safety (for use of charger)	2
1.3. Battery Safety	3
1.4. Electrical Safety (in operation)	3
1.5. Personal Safety	3
1.6. Operating Safety	3
2. Description, Specifications and Tool Components	4
2.1. Description	4
2.2. Specifications	4
2.3. Accessories Included	5
2.4. Tool Components and Ports	6
2.5. Buttons and Controls	8
3. Installation and Connection	10
3.1. The Imager Head and Cable Installation	10
3.2. Accessories Installation	10
3.3. Micro SD Card Installation	11
3.4. USB Cable Connection	11
3.5. Video-Out Cable Connection	11
4. Battery Charging Precautions	12
4.1. Battery Charging Safety	12
4.2. Battery and Charger Specifications	12
4.3. Charger Inspection	12
4.4. Battery Charging Procedures	13
5. Operation Instructions	13
5.1. Basic Operation	13
5.2. Operation Precautions	14
5.3. Tool Inspection	15
5.4. Tool and Work Area Set-Up	16
5.5. On Screen Navigation	17
5.6. Icons	26
5.7. Software Update	26
6. Troubleshooting	27
Declaration of Conformity	29

1. Safety Instructions

IMPORTANT: Failure to understand and follow the instructions listed below may result in electric shock, fire and/or serious personal injury.

1.1. Work Area Safety

- 1.1.1. Always perform automotive testing in a safe environment.
- 1.1.2. Ensure that work area is clean and well lit.
- 1.1.3. Keep clothing, hair, hands, tools, test equipment, etc. away from all moving or hot engine parts.
- 1.1.4. Operate the tool in a well-ventilated work area.
- 1.1.5. **DO NOT** operate the tool in explosive atmospheres.
- 1.1.6. Ensure that a suitable fire extinguisher is available.
- 1.1.7. **DO NOT** use the tool around corrosive chemicals which can damage the tool.
- 1.1.8. Keep unauthorised personnel and children clear of the work area whilst operating the tool.
- 1.1.9. Keep the tool dry, clean, free from oil, water and grease. Use a mild detergent on a clean cloth to clean the outside of the tool when necessary

1.2. Electrical Safety For Use Of Charger

- 1.2.1. **ONLY USE THE SUPPLIED CHARGER PLUG FOR CONNECTING TO THE POWER SUPPLY.**
- 1.2.2. **WARNING!** It is the user's responsibility to read, understand and comply with the following electrical instructions:
 - You must ensure the risk of electric shock is minimised by the installation of appropriate safety devices.
 - An RCCB (Residual Current Circuit Breaker) should be incorporated in the main distribution board. We also recommend that an RCD (Residual Current Device) is used with all electrical products, particularly portable equipment which is plugged into an electrical supply not protected by an RCCB.
 - You must also read and understand the following instructions concerning electrical safety:
- 1.2.3. **The Electricity At Work Act 1989** requires all portable electrical appliances, if used on business premises, to be tested by a qualified electrician, using a Portable Appliance Tester (PAT), at least once a year.
- 1.2.4. **The Health & Safety at Work Act 1974** makes owners of electrical appliances responsible for the safe condition of the appliance and the safety of the appliance operator. **If in any doubt about electrical safety, contact a qualified electrician.**
- 1.2.5. You must ensure that you:
 - Inspect the charger plug, cable and connector for wear and damage to ensure items are safe before connecting to the mains power supply.
 - If worn or damaged **DO NOT** use.
 - **Important:** Check that the voltage marked on the charger plug is the same as the power supply to be used.
 - Uncoil the cable.
 - **DO NOT** pull the charger plug from the mains socket by the lead.

WARNING! DO NOT use any other type of charger with this product, other than the supplied charger. Failure to observe this warning could result in injury and or fire and will invalidate the warranty.

- 1.2.6. **DO NOT** try to take the charger plug apart.
- 1.2.7. **DO NOT** use the charger plug to charge or power any other electrical item.
- 1.2.8. **DO NOT** get the charger wet, or use in wet, damp conditions (for indoor use only).

1.3. Battery Safety.

WARNING! To reduce the risk of burns or fire:

- 1.3.1. **DO NOT** attempt to open, disassemble, modify or service the battery pack.
- 1.3.2. **DO NOT** crush, puncture, short external contacts or dispose of in fire or water.
- 1.3.3. **DO NOT** expose to temperatures above 60°C (140°F).
- 1.3.4. Recycle or dispose of used battery as stipulated by local regulation.

1.4. Electrical Safety (in operation)

- 1.4.1. Avoid body contact with earthed or grounded surfaces such as pipes, radiators, ranges and refrigerators.
- 1.4.2. **DO NOT** expose the tool to rain or wet conditions. Water entering the tool will increase the risk of electric shock.
- 1.4.3. **DO NOT** abuse the cable. Never use the cable for carrying, pulling, or unplugging the tool. Keep cable away from heat, oil, sharp edges or moving parts.

1.5. Personal Safety

- 1.5.1. **DO NOT** use the tool while tired or under the influence of drugs, alcohol, or intoxicating medication.
- 1.5.2. **DO NOT** over-reach. Maintain proper footing and balance at all times.
- 1.5.3. **DO NOT** place the tool on any unstable surface. The tool may fall, causing injury to a person or damage to the tool.
- 1.5.4. Never spill liquid on the display unit.
- 1.5.5. **DO NOT** use the tool for personal or medical use in any way.
- 1.5.6. The product is not shock resistant. **DO NOT** use it as a hammer or drop it.

1.6. Operating Safety

- 1.6.1. Use the tool only as directed. **DO NOT** operate the tool unless the instruction manual has been read thoroughly.
- 1.6.2. The display unit is not waterproof. The imager head and cable are waterproof, but not acidproof or fireproof. Avoid submersing the imager head and cable into corrosive, oily places and be sure to keep the imager head and cable away from high temperature objects.
- 1.6.3. **DO NOT** immerse the display unit in water.
- 1.6.4. **DO NOT** use excessive force to insert or withdraw the imager head and cable. This may result in damage to the tool or inspection area.
- 1.6.5. **DO NOT** use the imager head and cable to modify surroundings, clear pathways or clogged areas.
- 1.6.6. **DO NOT** place the imager head and cable into anything or anywhere that may contain a live electric charge or moving parts.
- 1.6.7. **DO NOT** use the tool for personal inspection or medical use in any way. This is **NOT** a medical tool.
- 1.6.8. **DO NOT** eat or smoke while operating the tool. Use hot, soapy water to wash hands and other body parts exposed to drain contents after using the tool to inspect drains and other areas that may contain chemicals or bacteria.

- 1.6.9. When the inspection is completed, carefully withdraw the imager head and cable from inspection area.
- 1.6.10. Store components and accessories out of the reach of children and other untrained persons.
- 1.6.11. Maintain the tool with care. Properly maintained tools are less likely to cause injury.
- 1.6.12. **DO NOT** drop the tool. If the tool is accidentally dropped, check for damage.
- 1.6.13. Always wear appropriate personal protective equipment whilst handling and using the tool. A full range of PPE is available from your Sealey dealer.
- 1.6.14. Protect against excessive heat. The tool should be kept away from heat sources. **DO NOT** use the tool near moving machinery or in areas where the temperature will exceed 113°F (45°C).
- 1.6.15. After use, store the tool in a safe, dry, childproof area.

2. Description / Specification

2.1. Description

Ideal for the professional tradesman and technician. High performance pistol grip borescope with 89mm colour TFT screen. Ø5.5mm Digital output camera module ensures low-loss transmission of images to the hand-set and gives great image quality with excellent colour balance and contrast. Camera capsule is waterproof to 3mtr and has scratch resistant, tempered glass lens. Record and replay still and video images on the handset or stream live video via the USB/ AV connection. 128Mb integral memory allows the storage of up to 80 images or 90sec of video on the handset – use a Micro SD card (not included) in the expansion slot to increase your storage capacity if required. Features digital zoom control and rotate/flip control of the image – ideal for use in a tight spot or with a mirror. Powered by lithium-ion battery pack giving up to 4 hours continuous use. Supplied with an AV-out cable and USB cable to allow connection to a PC to capture, store and share images and video. Kit includes a 45° mirror, magnetic pick-up attachment and mains charger.

2.2. Specifications

Recommended use	Indoor
Optimal viewing Distance	3/8" to 12" (0.95cm to 30cm) with 5.5mm diameter imager head
Image capture	JPG images (640x480) AVI videos (320x240)
Screen type display	3.5" TFT LCD
Display resolution	320 x 240

Power supply	Built-in rechargeable lithium-ion battery pack (3.7V)
Tested battery life	3 to 4 hours of continuous use
Dimensions	199 x 100 x 178mm (7.83" x 3.94" x 7.0")
Weight	0.288kg (0.63lb)
Recording medium	Micro SD card (optional and not included)
Image controls	Zoom, low light vision
Lighting	Fully adjustable LED
Cable reach	1m (3') - expandable to 6m (19') with optional extensions
Imager head	5.5mm (0.22")
Waterproof	Imager head and cable to 3m (10')
Additional ports	USB, video out (TV out)
Operating temp.	Main unit: 32°F to 113°F (0°C to 45°C); Cable: 14°F to 176°F (-10°C to 80°C)
Storage temp.	-4°F to 158°F (-20°C to 70°C)
Operating humidity	5% - 95% non-condensing (display unit)
Video output	RCA
TV out	NTSC, PAL

2.3. Accessories Included

- 1) Protective carrying case
- 2) Instruction Manual
- 3) Imager head and cable (5.5mm)
- 4) Magnet and mirror
- 5) Charger
- 6) USB cable
- 7) Video-out cable (TV-out cable)

2.4. Tool Components and Ports

Note: Because of continuing improvements, actual product may differ slightly from pictures.

The VS8221 comes with the following items:

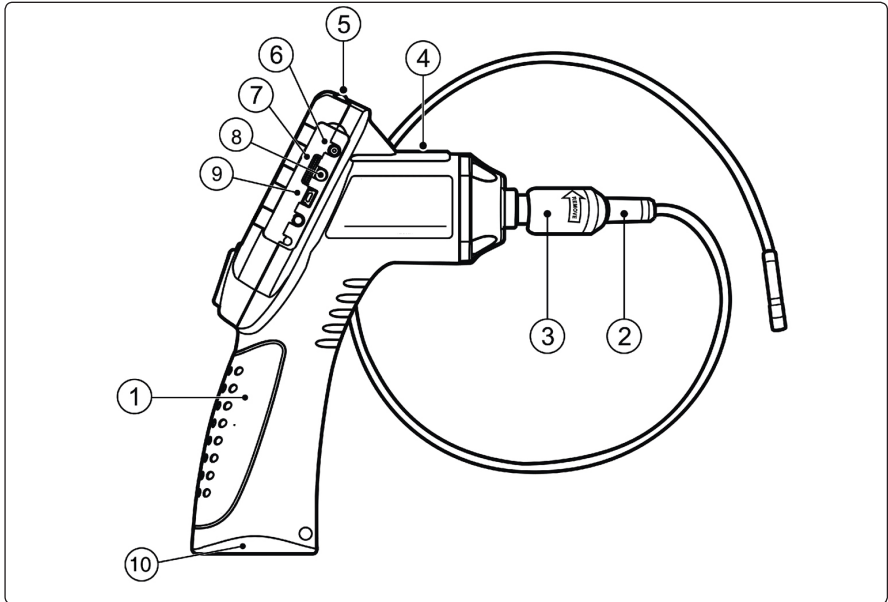

Fig.1

1. **Handheld Display Unit** – Ergonomic tool with comfortable pistol grip design.
2. **Imager Head and Cable** – Connects to the tool while in use to view images and videos.
3. **Cable Connector** – Connects the handheld display unit to the imager head and cable.
4. **Charging Indicator Light** – Illuminates red when charging and illuminates green when charging is completed.
5. **Power Button** – Turns the tool On/Off.
6. **DC Power Source Port** – Connects the tool to the mains with the supplied charger to power the tool or to charge the battery.
7. **Micro SD card Slot** – Holds the Micro SD card.
8. **Video-out Port** – Connects the tool to a TV with the supplied video-out cable to view the real-time image.
9. **Mini USB Port** – Connects the tool to a computer with the supplied USB cable to exchange information.
10. **Battery Compartment Cap**- Indicates to install or remove the battery.



Fig.2

11. **Accessory Magnet** – Picks up small metal objects such as dropped rings or screws.
12. **Accessory Mirror** – Helps users look around corners and see inside unreachable areas.
13. **Standard Attachment** – Allows users to see inside unreachable areas.

2.5. Buttons and Controls

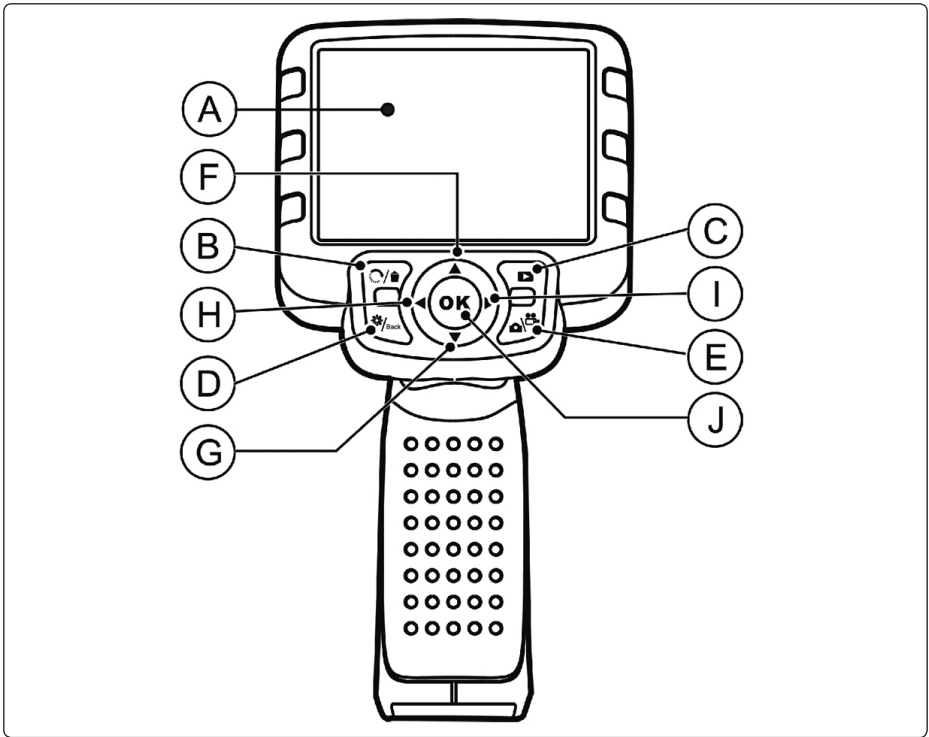

Fig.3

- A. **LCD Screen** – Indicates still images and videos.
- B. **Delete/Reverse Button** – Deletes captured photos and videos in the play mode. While capturing a photo or video, pressing Reverse Button will control the direction of the real-time image and video in the live screen. The real-time image and video will do a horizontal reverse or a vertical reverse.
- C. **Play Button** – Replays captured photos and videos.
- D. **Setting/Back Button** – Moves to the primary settings screen, pressing again will return to the last viewed screen.
- E. **Camera/Video Button** – Switches between two modes: camera or video.
- F. **UP Arrow Zoom Adjusting Button** – Use Up arrow button to zoom in while in the camera mode. Moves through menu and submenu items in menu mode.
- G. **DOWN Arrow Zoom Adjusting Button** – Use Down arrow button to zoom out while in the camera mode. Moves down through menu and submenu items in menu mode.

- H. **LEFT Arrow LED Lighting Adjusting Button** – Use Left arrow button to decrease LED brightness in the camera mode. Moves the cursor to the desired item. Moves to the previous image or video in the play mode.
- I. **RIGHT Arrow LED Lighting Adjusting Button** – Use Right arrow button to increase LED brightness in the camera mode. Moves the cursor to the desired item. Moves to the next image or video in the play mode.
- J. **OK Button** – Confirms a selection (or action) from a menu. Starts recording image or video in live mode. Starts or suspends file reviewing in play mode.

3. Installation and Connection

3.1. The Imager Head and Cable Installation

To use the tool, the imager head and cable must be connected to the display unit. To connect the cable to the display unit, make sure that the key and slot (Fig.4) are properly aligned. Once they are aligned, tighten the knurled knob to hold the connection firmly in place.

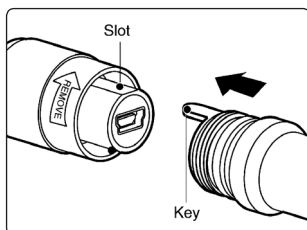

Fig.4

3.2. Accessories Installation

Accessories include a magnet and a mirror (Fig.2). Both are attached to the imager head in the same manner. Hold the accessory and the imager head as shown in Fig.5.

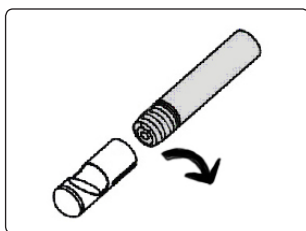

Fig.5

Screw the accessory onto the tip of the imager head.

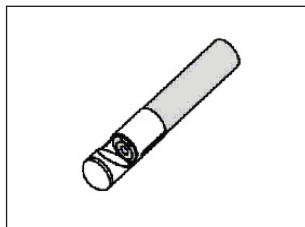

Fig.6

3.3. Micro SD Card Installation

NOTE: Micro SD card slot provides additional memory. The Micro SD card is optional and not included. Different Micro SD cards can be used to insert into the Micro SD card slot. The maximum supported size is 16GB.

To insert a Micro SD card into the Micro SD card slot, make sure the contacts are facing towards slot and the angled portion of the card is facing down. When the Micro SD card is installed, a small Micro SD card icon will appear at the top right hand corner of the screen. To remove the Micro SD card, gently push the Micro SD card inward and then release to eject it from the card slot.

3.4. USB Cable Connection

Use the supplied USB cable to connect the tool to a PC to upload and view captured photos and videos. A “**USB Connected**” message will appear on the screen.



Fig.7

3.5. Video-Out (TV-out) Cable Connection

Insert the video-out cable into the video-out port of the tool and the other end of the cable into the video-in port of a TV, the LCD screen will output a high quality real time image.

4. Battery Charging Precautions

IMPORTANT: To reduce the risk of serious injury, read these precautions and the label on charger carefully before using.

4.1. Battery Charging Safety (also see section 1.2 and 1.3).

DO NOT use charger if it has been dropped or damaged in any way.

Charge the battery in temperatures between 41°F (5°C) and 113°F (45°C).

Use the supplied charger only.

DO NOT allow anything to cover the charger while in use.

Unplug the charger from outlet before attempting any maintenance or cleaning.

DO NOT store charger in a damp, wet or explosive environment.

DO NOT open charger housing. Have repairs performed only at authorised suppliers.

DO NOT charge battery near fire or in sunlight.

Proper care will prevent serious damage to the charger.

4.2. Battery and Charger Specifications

Input	100-240V AC/12V DC 50/60Hz
Output	5V DC
Battery Type	3.7V Lithium-ion
Battery Capacity	1640mAh
Input Current	0.4A (DC or USB)
Charging Time	5-6 hours
Cooling	Passive convection cooling (No fan)

4.3. Charger Inspection

CAUTION: Before using, inspect the charger for damage. Set up charger according to these procedures to reduce the risk of injury from electric shock, fire and other causes and prevent tool damage.

- 4.3.1. Make sure charger is unplugged. Inspect the power cord and charger for damage, modifications, broken, worn, missing, or misaligned parts. If any problems are found, **DO NOT** use the charger until the parts have been repaired or replaced.
- 4.3.2. Clean any oil, grease or dirt from the tool especially on the buttons. This helps prevent the tool from slipping from your hands and allows proper ventilation.
- 4.3.3. Inspect if the warning label on charger's surface is intact and readable.
- 4.3.4. Select appropriate location for charger before using.
- 4.3.5. The charger must be between 41°F (5°C) and 113°F (45°C) for charging.
- 4.3.6. Check that the plug fits correctly into the outlet.
- 4.3.7. The charger needs a clearance of at least 4" (10cm) on all sides to maintain a proper operating temperature.

4.4. Battery Charging Procedures

NOTE: New battery reaches full capacity after approximately 5 charging and discharging cycles.

- 4.4.1. The tool has a 3.7V built-in Lithium-ion rechargeable battery. When the battery is too low, the Battery Capacity icon will blink 25 times and the tool will shut down automatically.

There are two means of charging the battery:

- 4.4.2. To charge battery by charger: Locate the DC power source port on the tool. With dry hands, connect the tool to the mains with charger to start charging.
- 4.4.3. To charge battery by USB cable: Locate the USB port. With dry hands, connect the tool to a PC with USB cable to start charging.
- The battery will begin charging automatically. Whilst the battery is charging, the charging indicator light will illuminate red.
- 4.4.4. When the battery is fully charged, the charging indicator light will illuminate green and the charger will stop charging.
- 4.4.5. Once the battery is charged, it is ready to be used. There is no risk of over-charging the battery. Unplug charger from outlet once charging completes.

5. Operation Instructions

IMPORTANT: Always wear safety eye protection to protect your eyes against dirt and other objects. Follow operation instructions to reduce the risk of injury from electric shock, entanglement and other causes.

5.1. Basic Operation

NOTE: When in operation, the cable can be bent into different shapes. This may help you operate in confined areas.

- 5.1.1. Hold the tool with the LCD screen facing you and press the **Power** button to turn it on. Wait for two seconds, the first screen - a splash screen displays while booting up, followed by the live screen.
- 5.1.2. Press **OK** button to capture photos while in the camera mode; Press **OK** button to begin capturing videos while in the video mode. Press **Camera/Video** button to switch between the two modes.
- 5.1.3. Press **UP and DOWN** arrow buttons to zoom in or out while in the camera mode, you can see a zoom indicator bar as you adjust zoom.
- 5.1.4. Press **LEFT and RIGHT** arrow buttons to decrease or increase screen backlighting while in the camera mode, you can see a brightness indicator bar as you adjust the LED light intensity.
- 5.1.5. Press **Play** button to view captured photos and videos.
- 5.1.6. Press **Delete/Reverse** button to delete captured photos and videos when playing back captured photos and videos.
- 5.1.7. Press **Delete/Reverse** button to control the direction of the real-time image and video as required in the live screen.

- 5.1.8. Press **Setting/Back** button to enter **Setup** mode or return to the last viewed screen.
- 5.1.9. Use the supplied accessories to provide application flexibility.
- 5.1.10. Use the supplied USB cable to connect the tool to a PC to upload and view captured photos and videos.
- 5.1.11. Connect the supplied video-out (TV-out) cable to video-out port of the tool and the other end of the cable to the video-in port of a TV to view a high quality real time image.

5.2. Operational Precautions

- 5.2.1. Use the tool only as directed. **DO NOT** operate the tool unless this user's manual has been read thoroughly and proper training has been completed.
- 5.2.2. The display unit is not waterproof. The imager head and cable are waterproof, but not acid-proof or fireproof. Avoid submersing the imager head and cable into corrosive, oily places and be sure to keep the imager head and cable away from high temperature objects.
- 5.2.3. **DO NOT** immerse the tool/display unit in water.
- 5.2.4. **DO NOT** use excessive force to insert or withdraw the imager head and cable. This may result in damage to the tool or inspection area.
- 5.2.5. **DO NOT** use the imager head and cable to modify surroundings, clear pathways or clogged areas.
- 5.2.6. **DO NOT** place the imager head and cable into anything or anywhere that may contain a live electric charge or moving parts, which increase the risk of electric shock or entanglement injuries.
- 5.2.7. **DO NOT** use the tool for personal inspection or medical use in any way. This is not a medical tool.
- 5.2.8. **DO NOT** eat or smoke while operating the tool. Use hot, soapy water to wash hands and other exposed skin after using the tool to inspect drains and other areas that may contain chemicals or bacteria.
- 5.2.9. When the inspection is completed, carefully withdraw the imager head and cable from inspection area.
- 5.2.10. Store idle components out of the reach of children and other untrained persons.
- 5.2.11. Maintain the tool with care. Properly maintained tools are less likely to cause injury.
- 5.2.12. **DO NOT** drop the tool, if the tool is dropped accidentally, check for breakage and any other conditions that may affect its operation.
- 5.2.13. Use only accessories that are recommended by the manufacturer for the tool.
- 5.2.14. Dry your hands when operating the tool or charging battery.
- 5.2.15. Always use appropriate personal protective equipment while handling and using the tool. Appropriate personal protective equipment always includes safety glasses and gloves, and may include latex or rubber gloves, face shields, goggles, protective clothing, respirators and steel toed footwear.

- 5.2.16. Protect against excessive heat. The tool should be kept away from heat sources such as radiators, stoves or others that produce heat. **DO NOT** use the tool near moving machinery or areas where the temperature will exceed 113°F (45°C).
- 5.2.17. Store the tool, charger and all cables in a locked area out of the reach of children and people unfamiliar with tool.

5.3. Tool Inspection

WARNING: Before using, inspect the borescope and correct any problems to reduce the risk of serious injury from electric shock and other causes and prevent tool damage.

- 5.3.1. Make sure the power is **OFF**.
- 5.3.2. Clean any oil, grease or dirt from the tool, especially on the buttons and ports. This helps prevent the tool from slipping from your hands.
- 5.3.3. Inspect the imager head lens for condensation. To avoid damaging the tool, **DO NOT** use the tool if condensation forms inside the imager head. Let the water evaporate before using again.
- 5.3.4. Inspect the full length of the cable for cracks or damage.
- 5.3.5. Make sure the connections between the display unit and imager head and cable are tight. All connections must be properly assembled for the cable to be waterproof.
- 5.3.6. Check if the warning label is present, firmly attached and readable. **DO NOT** operate the tool without the caution label.
- 5.3.7. Turn the power on and make sure that the tool displays the splash screen and then displays the live screen.
- 5.3.8. If the tool does not work after being turned on, have the tool checked by a qualified technician. Any tool that cannot be controlled with the power button is dangerous and must be repaired.

NOTE: Please check the following methods to avoid injury:

FOR WALLS: Before inspecting the inside of walls, be sure to close the electrical circuit breaker to the whole house before using the tool.

FOR PIPES: If you suspect a metal pipe could contain electric cables, have a qualified electrician check the pipe before inspecting it.

FOR CARS: Ensure that the engine is not running during inspection. Metal and liquid under the bonnet may be hot. **DO NOT** get oil or fuel on the imager head.

5.4. Tool and Work Area Set-Up

CAUTION: Set up the borescope and work area according to these procedures to reduce the risk of injury from electric shock, entanglement, and other causes and prevent tool damage.

- 5.4.1. Check work area for:
Sufficient lighting.
DO NOT work in area until flammable sources have been identified and corrected. The tool is not explosion proof and can cause sparks.
DO NOT use the tool while standing in water.
- 5.4.2. Check the area and determine if VS8221 borescope is the correct tool for the job.
- 5.4.3. Check the access points to the area.
- 5.4.4. Check if there is any electric power supplied to the area to be inspected.
- 5.4.5. Check if any liquids will be encountered during the inspection.
- 5.4.6. The Image head and cable are waterproof to a depth of 3m (10'), Greater depths may cause leakage into the imager head and cable and cause electric shock or damage the tool. The display unit is not waterproof and should not be exposed to wet conditions.
- 5.4.7. Check if any chemicals are present, especially in the case of drains. Chemicals may damage the tool.
- 5.4.8. Check the temperature of the area. The working temperature of the tool is between 32°F (0°C) and 113°F (45°C).
- 5.4.9. Check if any moving parts are present in the area.
- 5.4.10. Make sure that the tool has been properly inspected.
- 5.4.11. Install the correct accessories for use in the appropriate application.

- **CAUTION: Make sure the borescope has been powered off before performing maintenance.**

- 5.4.12. Tool maintenance must be performed only by qualified repair personnel.
- 5.4.13. Maintenance performed by unqualified personnel could cause injury.
- 5.4.14. When maintaining, use only identical replacement parts. Use of unauthorised parts or failure to follow maintenance instructions will invalidate warranty.
- 5.4.15. **DO NOT** attempt to take the tool apart.
- 5.4.16. Follow instructions to change accessories.
- 5.4.17. **DO NOT** use acetone to clean the tool. Instead, use only alcohol to swab the connections. Avoid rubbing too hard on the LCD screen. After using, wipe the display unit clean, gently with a dry cloth.
- 5.4.18. Always handle the tool with care. It is not shock-resistant.
- 5.4.19. **DO NOT** disassemble the tool beyond what is shown in the manual. Doing so will void the warranty.

5.5. On Screen Navigation

5.5.1. Splash Screen

When the tool is powered on, the first screen displayed is referred to as the splash screen (**Fig.8**). This screen tells you the tool is booting up. Once the tool is fully powered up, the screen will automatically switch to the live screen.



Fig.8

5.5.2. Live Screen

The live screen is where you will do most of your work. A live image of what the imager head sees is displayed on the screen. You can zoom, adjust screen backlighting, rotate images and videos, view and capture photos and videos from this screen.

5.5.3. Switching from Still Image Capture to Video Capture

The tool defaults to still image capture when powered on. Press **Video/Camera** button to switch between still image capture and video capture as required.

5.5.4. Adjusting Screen Backlighting

Pressing **RIGHT** and **LEFT** arrow buttons on the key pad (in the still camera mode) will increase or decrease the backlighting. A brightness indicator bar will be displayed on the screen as you adjust brightness (**Fig.9**).

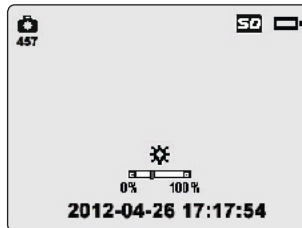

Fig.9

5.5.5. Zooming

Press **UP** and **DOWN** arrow buttons while in the still camera mode to zoom in or out. A zoom indicator bar will be displayed on the screen as the zoom is adjusted (**Fig.10**).

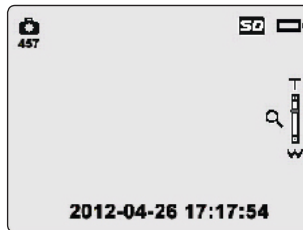

Fig.10

5.5.6. Entering the Primary Settings Screen

Pressing the **Setting** button while in the live screen will take you to the primary settings screen (**Fig.11**). Pressing the **Back** button at any point will take you back to the live screen.

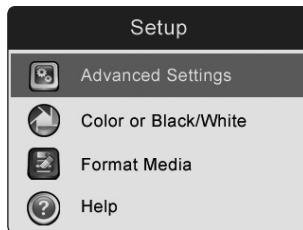

Fig.11

5.5.7. Colour or Monochrome

In the **Setup** screen, select **Colour** or **Monochrome** and press **OK** button, then the **Colour** or **Monochrome** setting screen will appear (**Fig.12**).

NOTE: Colour is the default mode.



Fig.12

Use the **LEFT/RIGHT** button to move to the desired option, then press **OK** button to save configuration and exit, or press **Back** button to exit without saving changes.

5.5.8. Format Media

In the **Setup** screen, select **Format Media** and press **OK** button, then the Format Media setting screen will appear (**Fig.13**).

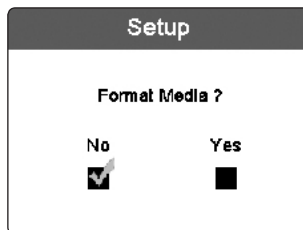

Fig.13

If you want to format the media (in most cases, it is the Micro SD card), use the **LEFT/RIGHT** button to select **Yes**, then press **OK** button to begin formatting. When formatting is finished, it will take you back to the primary settings screen.

If you do not wish to format media, use the **LEFT/RIGHT** button to select **No**, then press **OK** button to return to previous menu, or press **Back** button to exit.

NOTE: Before performing the formatting, make sure you have reviewed the recorded files thoroughly.

5.5.9. Help

This function provides the firmware version information.

In the **Setup** screen, select **Help** and press **OK** button, then the firmware version screen will appear (**Fig.14**).



Fig.14

5.5.10. Entering the Secondary Settings Screen

While in the Primary Settings Screen (**Fig.11**), select **Advanced Settings** from **Setup** and then press the **OK** button, you will enter the secondary settings screen (**Fig.15**) where you can set **Date/Time**, **Language** and **TV-out** as needed. Pressing the **Back** button at any point will bring you back to the primary settings screen and pressing it again will bring you back to the live screen.

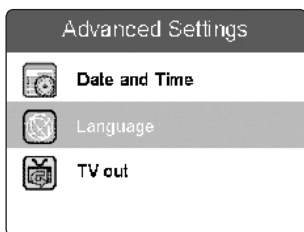

Fig.15

5.5.11. Date and Time

In the **Advanced Settings** screen, select **Date and Time** and press **OK** button, then the Date and Time setting screen will appear (**Fig.16**).

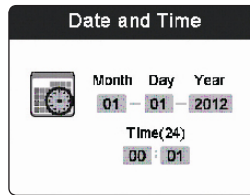

Fig.16

Use the **LEFT/RIGHT** button to move to the desired dialog box, then use the **UP/DOWN** button to increase or decrease the number. When finished, press **OK** button to save configuration and exit, or press **Back** button to exit without saving changes.

5.5.12. Language

In the **Advanced Settings** screen, select **Language** and press **OK** button, then the Language setting screen will appear (**Fig.17**).

English is the default language.



Fig.17

Use the **UP/DOWN** button to move to the desired language, then press the **OK** button to save configuration and exit, or press **Back** button to exit without saving changes.

5.5.13. TV-out

In the **Advanced Settings** screen, select **TV out** and press **OK** button, then the TV output setting screen will appear (**Fig.18**).

NTSC is the default standard.



Fig.18

Use the **UP/DOWN** button to select the desired setting, then press **OK** button to save configuration and exit, or press **Back** button to exit without saving changes.

5.5.14. Capturing a Photo

When in the live screen, make sure the camera icon is present at the top left portion of the screen (**Fig.19**). Press the OK button to capture a photo and simultaneously the photo has been saved to internal memory or the Micro SD card if available.



Fig.19

NOTE: Figure at the top left under the camera icon indicates how many photos you can save in the space left.

5.5.15. Capturing a Video

While in the live screen, make sure the video icon is present at the top left portion of the screen. Press **OK** button to start capturing video (**Fig.20**). You will notice that a red **REC** icon appears at the top right portion of the screen, just below battery capacity icon. This shows that video is capturing. The time at the top left portion, just below video icon, will begin counting. The time at the top left portion, just below video icon, will begin counting. This indicates how long the video has been captured. Press **OK** button again to stop capturing a video.



Fig.20

It may take few seconds to save the captured video to internal memory. The tool can capture a video of approximately 80 seconds without a Micro SD card.

NOTE: before capturing a video, figure at the top left under the video icon indicates how long a section of video you can save in the space left (**Fig.21**).



Fig.21

5.5.16. Playing Back and Deleting Captured Photos and Videos

Pressing **Play** button, the captured photo and video files will display on the screen (**Fig.22**). Photos and videos captured will be saved as separate files based on different format.



Fig.22

While viewing these photos and videos, press **OK** button to select, and then the screen will display as below (**Fig.23**). The digit on the top left portion of the screen shows sequence number of the playing file and total number of files in the folder.

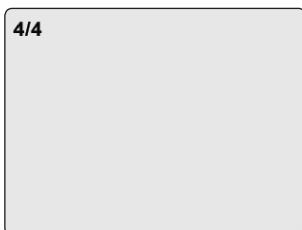

Fig.23

Use the **LEFT** button to play the previous file, the **RIGHT** button to the next file. Or, use the **UP** button to play the file on the previous line, the **DOWN** button to the file on the next line.

While selecting a video to play, press **OK** button to start, suspend or resume the process. Anytime pressing **BACK** button will stop playing and exit.

While reviewing a photo or video, press **Delete/Reverse** button to delete the recorded files, and the screen will display as below (**Fig.24**).

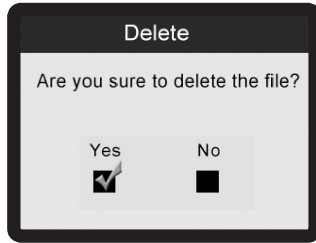

Fig.24

Select **Yes** to confirm your selection and press **OK** button to delete the file, or select **No** to cancel the command and press **OK** button to exit.





NOTE: Files or videos can only be deleted one by one.

When you delete all the photos or videos, a “**No Files Available**” message appears on the screen (**Fig.25**).



Fig.25

5.6. Icons

- 1)  – **DC Power** – Indicates the tool is supplied by external power.
- 2)  – **Battery Capacity** – Fully charged battery.
- 3)  – **Micro SD Card** – Indicates a Micro SD card has been inserted into the tool.
- 4)  – **Still Camera** – Indicates the tool is operating in still camera mode.
- 5)  – **Video Camera** – Indicates the tool is operating in video camera mode.

5.7. Software Update

NOTE: The tool supports software update when there is new progress with software or system. We offer free update file for the tool.

- 5.7.1. Format the Micro SD card to FAT file format on a computer.
- 5.7.2. Visit our website - www.sealey.co.uk and download software update file to the Micro SD card.
- 5.7.3. Insert the Micro SD card into the Micro SD card slot. (See 3.3 Micro SD card Installation)
- 5.7.4. Press **Power** button to turn on the tool and then press **UP** button until the update screen appears, select **YES** to upgrade the tool (**Fig.26**).

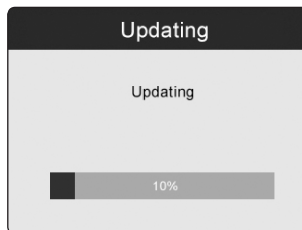

Fig.26

6. Troubleshooting

SYMPTOMS	POSSIBLE REASONS	SOLUTIONS
Display is on, but does not show image.	Cable connection is loose.	Check and reattach.
	Imager head is covered by debris.	Inspect the imager head and clean if necessary.
LEDs on imager head are dim at max brightness, display changes between black and white, color display turns itself OFF after a short period.	Low battery.	Charge battery.
The tool will not turn on.	Dead battery.	Charge battery.

Environmental Protection.



Recycle unwanted materials instead of disposing of them as waste.

All tools, accessories and packaging should be sorted, taken to a recycle centre and disposed of in a manner which is compatible with the environment.



When the product is no longer required, it must be disposed of in an environmentally protective way. Contact your local solid waste authority for recycling information.

Battery Removal.

Before disposing of the product, the battery needs to be removed and recycled.

Open the battery compartment cover by removing the screw using a cross head screwdriver, then slide cover off. Grip the battery and remove it.

Handle the Li-ion battery with care, do not puncture it or expose it to heat.

Slide the cover back into place. Secure with the screw.



Dispose of battery according to local authority guidelines.

Under the Waste Batteries and Accumulators Regulations 2009, Jack Sealey Ltd are required to inform potential purchasers of products containing batteries (as defined within these regulations), that they are registered with Valpak's registered compliance scheme. Jack Sealey Ltd's Batteries Producer Registration Number (BPRN) is BPRN00705

Parts support is available for this product. To obtain a parts listing and/or diagram, please log on to www.sealey.co.uk, email sales@sealey.co.uk or phone 01284 757500.

NOTE: It is our policy to continually improve products and as such we reserve the right to alter data, specifications and component parts without prior notice.

IMPORTANT: No liability is accepted for incorrect use of this product.

WARRANTY: Guarantee is 12 months from purchase date, proof of which will be required for any claim.

INFORMATION: For a copy of our latest catalogue and promotions call us on 01284 757525 and leave your full name and address, including postcode.



Sole UK Distributor, Sealey Group,
Kempson Way, Suffolk Business Park,
Bury St. Edmunds, Suffolk,
IP32 7AR



01284 757500



01284 703534



www.sealey.co.uk



sales@sealey.co.uk



EC DECLARATION OF CONFORMITY

We the sole importers into the UK, hereby declare that the equipment described below

Description and Function: **ProScope 2 Digital Borescope Ø5.5mm**

Model/Type: **VS8221**

Manufacturing Date / Serial number (optional):

Manufacturer's authorised representative within the EC: **Jack Sealey Ltd. Kempson Way, Suffolk Business Park, Bury St. Edmunds, Suffolk, IP32 7AR**

Conforms to the requirements of the following Directives, as indicated.

- 2006/42/EC Machinery Directive
- 2000/14/EC Outdoor Noise Emissions Directive
- 2006/95/EC Low Voltage Directive
- 2002/96/EC WEEE Directive
- 2004/108/EC EMC Directive
- 2002/95/EC RoHS Directive
- 93/68/EEC CE Marking Directive
- 97/23/EC Pressure Equipment Directive
- 2009/105/EC the Simple Pressure Vessels Directive

And the following harmonised standard(s)

BS EN 55022: 2006 + A1: 2007

BS EN 61000 part: 4-2: 2009

BS EN 55024: 1998 + A1: 2003

BS EN 61000 part 4-3: 206 + A1: 2008

Additional technical standards and specifications (if applicable):

Technical file compiled by: **Jack Sealey Ltd.**

Signed:

Date: 05-Jul-2012

Place: Bury St. Edmunds.

Name: Tim Thompson

Position: Commercial Director

Being the responsible person appointed by the manufacturer.



Sealey Power Products, Kempson Way, Suffolk Business Park, Bury St. Edmunds, Suffolk, IP32 7AR

01284 757500

01284 703534

sales@sealey.co.uk

www.sealey.co.uk