

Instructions for:

### PETROL ENGINE TWIN CAMSHAFT SETTING / LOCKING TOOL KIT FIAT 1.8 16v & 2.0/2.4 20v

Model No: **VS4915, VS4920**

Thank you for purchasing a Sealey product. Manufactured to a high standard this product will, if used according to these instructions and properly maintained, give you years of trouble free performance.



**IMPORTANT: PLEASE READ THESE INSTRUCTIONS CAREFULLY. NOTE THE SAFE OPERATIONAL REQUIREMENTS, WARNINGS AND CAUTIONS. USE THE PRODUCT CORRECTLY AND WITH CARE FOR THE PURPOSE FOR WHICH IT IS INTENDED. FAILURE TO DO SO MAY CAUSE DAMAGE AND/OR PERSONAL INJURY AND WILL INVALIDATE THE WARRANTY. PLEASE KEEP INSTRUCTIONS SAFE FOR FUTURE USE.**



VS4915

VS4920

## 1. SAFETY INSTRUCTIONS

- WARNING!** *Ensure Health and Safety, local authority and general workshop practice regulations are adhered to when using tools.*
- DO NOT** use tools if damaged.
- Maintain tools in good and clean condition for best and safest performance.
- Ensure that a vehicle which has been jacked up is adequately supported with axle stands.
- Wear approved eye protection. A full range of personal safety equipment is available from your Sealey dealer.
- Wear suitable clothing to avoid snagging. Do not wear jewellery and tie back long hair.
- Account for all tools, locking bolts, pins and parts being used and do not leave them in or near the engine.
- WARNING!** Incorrect or out of phase camshaft timing can result in contact between valve head and piston crown causing damage to the engine.

**IMPORTANT:** These instructions are provided as a guide only. Always refer to the vehicle manufacturer's service instructions, or a proprietary manual, to establish the current procedure and data.

**WARNING:** The warnings, cautions and instructions discussed in this manual cannot cover all possible conditions and situations that may occur. It must be understood that common sense and caution are factors which cannot be built into this product, but must be applied by the operator.

## 2. INTRODUCTION / SPECIFICATION

FIAT 1.8 16v. & 2.0 / 2.4 20v. Twin Camshaft petrol engines  
Engine timing and timing belt replacement applications in  
FIAT

Punto	Brava/Bravo	Marea / Weekend
Barchetta	Coupe	Stilo

**VS4915 Kit** – FIAT 1.8 16v. engines

**VS4920 Kit** – FIAT 1.8 16v. PLUS 2.0 / 2.4 20v. engines

**Engine codes:**

**1.8 16v.** – 182A2.000, 183A1.000, 183A6.000, 188A6.000, 192A4.000

**2.0 / T 20v.** – 175A3.000, 182A1.000, 182B3.000, 182B7.000

**2.4 20v.** – 192A2.000

**Additional VS Tools required**

AK9634M Dial Test Indicator (use with VS1404)

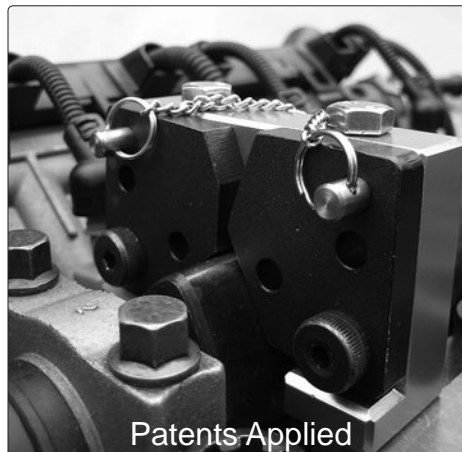

VS4915 and VS4920  
FIAT Setting / Locking  
Tool Kits are based on  
the AL - Fi  
UNIVERSAL  
CAMSHAFT SETTING  
PLATE SYSTEM

Patents Applied



Associated tool VS1404

### 3. CONTENTS

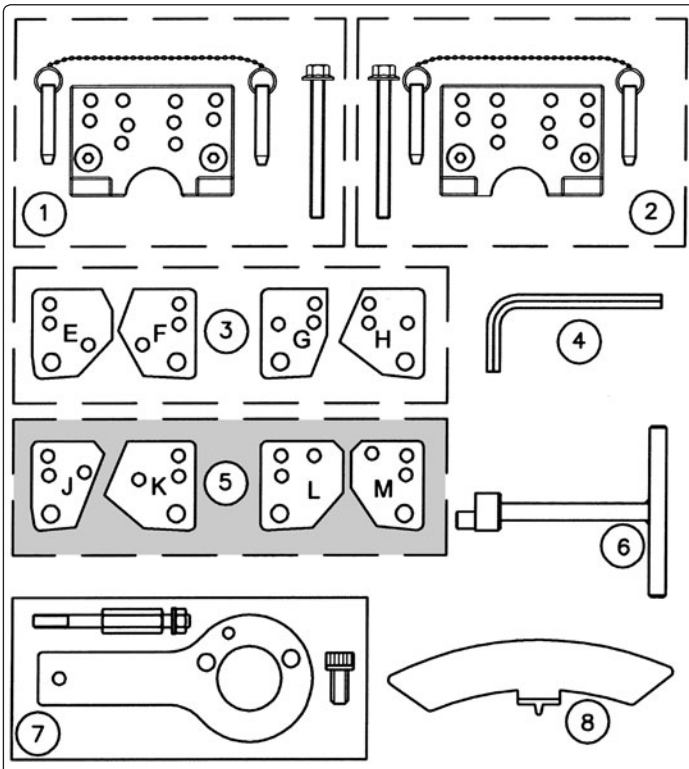

Kits VS4915 and VS4920 have the same AL - Fi System components and Timing Tools, as detailed under Items 1, 2, 3, 4, 6, 7 and 8 in the Spares diagram.

Kit VS4920 additionally has component 5\* - VS4903 AL - Fi Setting Plate Set (J, K, L, M) to cover FIAT 2.0 / 2.4 20v. engine applications.

Item	Part Number	Description
1	VS4900/1	Support Block Assembly (Inlet Camshaft) c/w Retaining Bolts (2), Securing Screws (2) & Location Pin Assy.
2	VS4900/2	Support Block Assembly (Exhaust Camshaft) c/w Retaining Bolts (2), Securing Screws (2) & Location Pin Assy.
3	VS4902	Set of 4 Setting Plates E & F Inlet Camshaft G & H Exhaust Camshaft
4	VS4900/6	Allen Key
5*	VS4903	Set of 4 Setting Plates J & K Inlet Camshaft L & M Exhaust Camshaft
6	VS1403/04	Timing Belt Tensioner Adjuster
7	VS1405/02	Crankshaft Locking Tool
8	VS1403/03	Flywheel Holding Tool (Crank Pulley removal)
--	VS4920/84	Case + Insert

#### Twin Camshaft Petrol Engines FIAT 1.8 16v. and 2.0 / 2.4 20v. Tool Application Chart / AL - Fi Setting Plate Guide

	Crankshaft TDC		Camshaft AL-Fi Plate Reference	Belt Tension VS1403/04	Crank Pulley Removal VS1403/03
	VS1404 Associated Tool	VS1405/02			
<b>FIAT 1.8 16v.</b> <b>Punto, Brava / Bravo, Marea / Weekend, Barchetta, Coupe</b> 183A1.00 / 182A2.000	●		Set VS4902 Plates E,F,G,H	●	
<b>Punto, Stilo</b> 183A6.000 / 188A6.000 / 192A4.000		●	Set VS4902 Plates E,F,G,H	●	
<b>FIAT 2.0/2.4 20v./T</b> <b>Bravo, Stilo, Coupe</b> 175A3.000 / 182A1.000 / 182B3.000 / 182B7.000 / 192A2.000	●		Set VS4903 Plates J,K,L,M		

### 4. INSTRUCTIONS

#### 4.1 General Guide – Setting & Locking FIAT Twin Cam engines

Fig.1

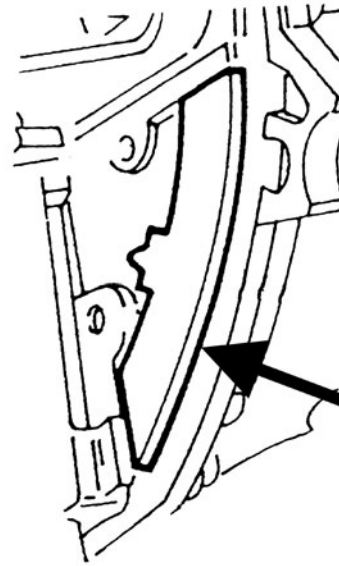

#### VS1403/03 Flywheel Holding Tool - (Crank Pulley removal)

In order to remove the timing belt it will be necessary to remove the crankshaft pulley.

Remove the flywheel access cover and install VS1403/03 Flywheel Holding Tool to 'lock' the engine to facilitate release of the crank pulley bolt, once the cam setting plates have been fitted. (Fig.1).

#### 4.1.1 Crankshaft Timing Position

Timing belt replacement on the majority of these FIAT twin cam engines is carried out with the crankshaft at TDC No. 1 cylinder, established by using VS1404 TDC Position Tool and a suitable DTI, **OR** on certain 1.8 16v. engines, by using Crankshaft Locking Tool VS1405/02 – refer to Application Chart to determine which Tool is used for the engine code being worked on.

**NOTE:** To avoid kit contents duplication, VS1404 TDC Position Tool is not included in individual kits but is available as an Associated Tool. It is used on Fiat 1.6, 1.8, 2.0, 2.4 Twin Cams and Alfa Romeo Twin Spark engines.

Fig.2

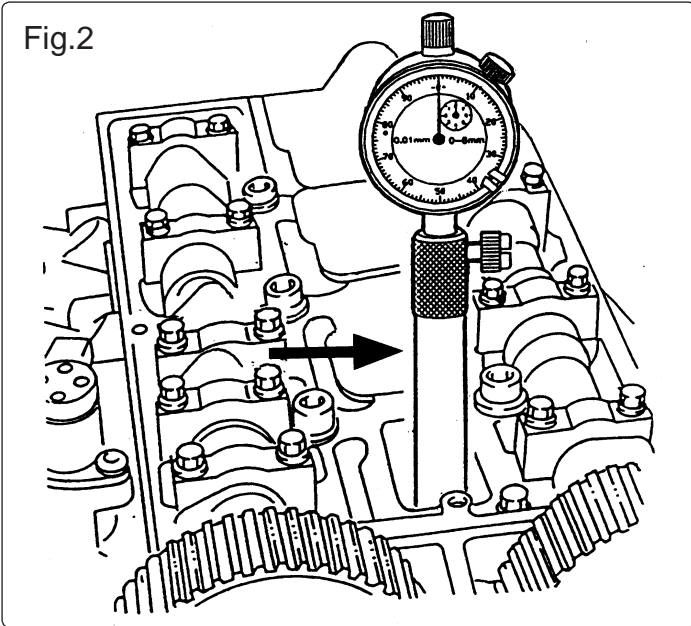

**4.1.2 VS1404 TDC Position Tool**  
**Associated Tool – not in kit**

The correct engine/crank TDC position is established using VS1404 Tool together with a suitable DTI, such as AK9634M Dial Gauge. (Fig.2).

VS1404 Tool determines when the piston of No. 1 cylinder is at its highest point.

**NOTE: must be when it is on its ignition stroke.**

Remove the spark plugs and install the DTI into VS1404 and secure with the thumbscrew.

Screw the VS1404 **fully** into the centre spark plug hole of No. 1 cylinder, taking care not to over tighten.

By turning the crankshaft, in the normal direction of engine rotation, the piston will raise the indicator pin of VS1404 and in turn, move the needle of the DTI.

TDC is achieved when the DTI needle reaches its highest reading and starts to move in the reverse direction.

Check that all timing marks align.

Fig.3

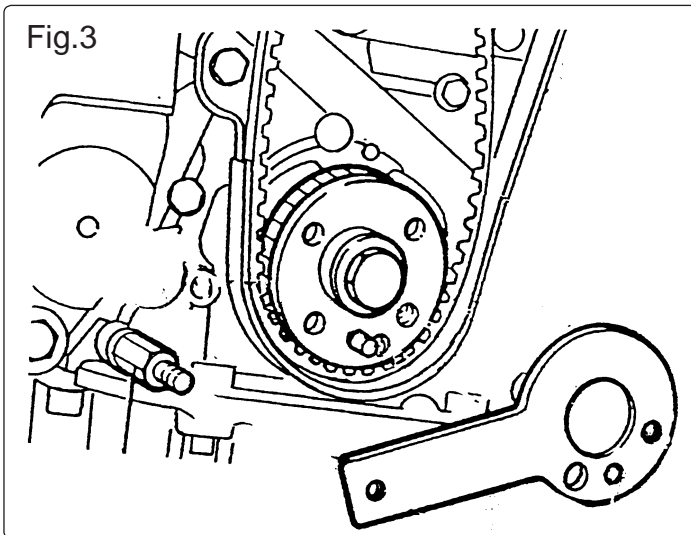

**4.1.3 VS1405/02 Crankshaft Locking Tool**

To fit VS1405/02 Locking Tool remove the oil pump bolt and insert Support Spindle of VS41405/02.

Turn the crankshaft a little at a time to locate the dowel on the crank gear into the hole in the main body of the tool.

Fix VS1405/02 with the dowel correctly located and secure with a bolt through to the crank gear, placing a washer both sides of the main body of the tool. (Fig.3).

**4.1.4 NOTE:** Having established the crankshaft position and fitted the **AL - Fi Camshaft Setting Plates**, the VS1405/02 must be removed and then re-fitted in order to fit the new timing belt.  
 Fit a new belt in the following sequence – crank gear, guide roller, exhaust cam sprocket, Inlet cam sprocket, water pump and tensioner.

Fig.4

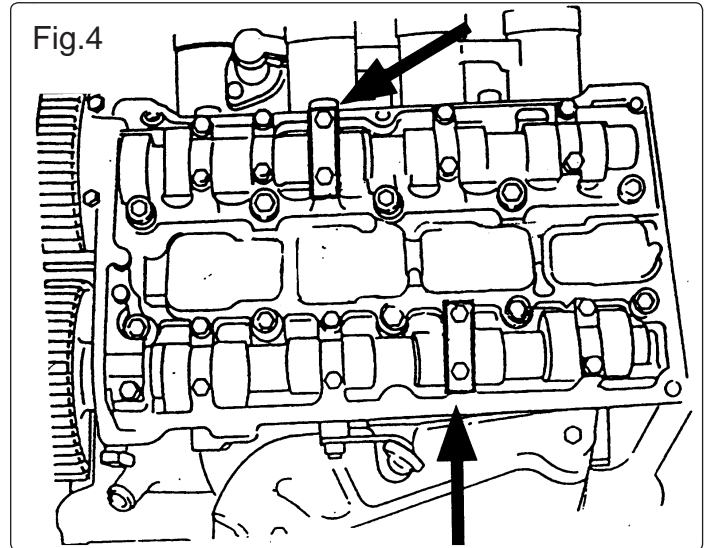

**4.2 Camshaft timing**

The camshafts are retained in their 'timed' positions by use of **Camshaft Setting Plate Assemblies which are fixed on the engine in place of designated bearing caps, at specified cylinder locations.** (Fig.4).

The VS4915 / VS4920 Timing Kits are based on the unique **AL - Fi Camshaft Setting Plate System.**

The **AL - Fi range** of Universal Camshaft Setting Plates provide wide application coverage across engine ranges by utilising common **Support Blocks** – one for all Inlet Camshafts, and one for all Exhaust Camshafts.

**Inter-changeable Setting Plates** are mounted on to these Support Blocks.

The position of the Setting Plates on the Support Blocks is adjustable in order to provide maximum coverage of engine ranges.

**Refer to "AL - Fi System parts selection and assembly"**

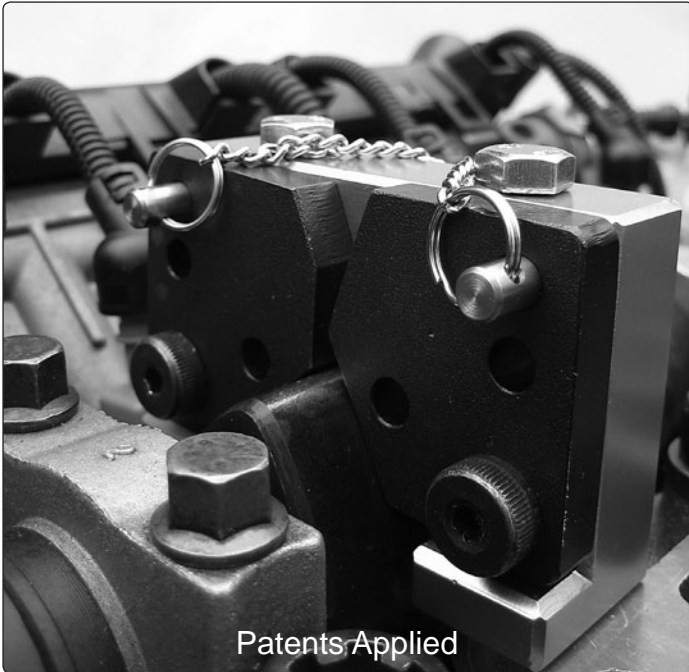

Patents Applied

**NOTE:** Both camshaft sprockets are released and free to turn on camshafts, when fitting and initially tensioning a new belt.

#### 4.3 Belt Tensioning Sequence

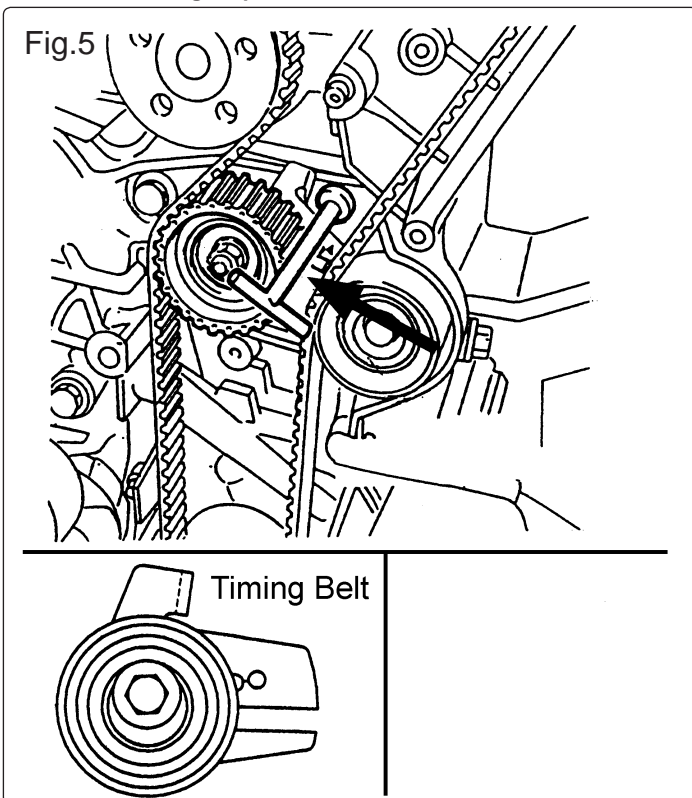

##### 4.3.1 VS1403/04 Tensioner Adjuster

This 'T-Handle' Adjuster is inserted through an opening in the tensioner support and after fitting new belt, turned to initially adjust to maximum tension position. (Fig.5).

Tighten both camshaft sprocket bolts counter-holding sprockets with a suitable Holding Tool.

Remove the Camshaft Setting Plates and the Crank Locking Tool.

Re-fit the camshaft bearing caps and tighten bolts to specified torque.

Rotate the crankshaft two revolutions, by hand, and return to the TDC position.

Adjust tensioner to final position using VS1403/04 so that the pointer aligns with the reference on the crankcase – (Fig.6).

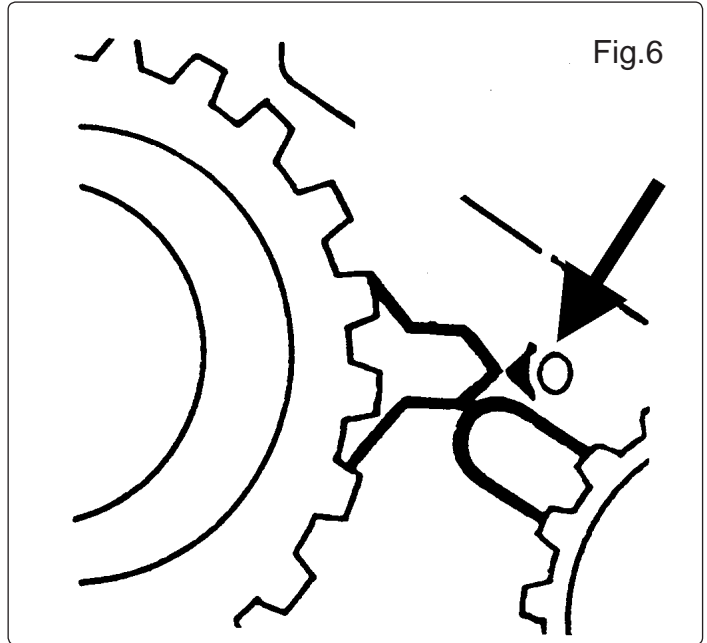

1.8 16v. Final tensioner position

#### 4.4 Introduction to the AL - Fi Universal Camshaft Setting Plate System

##### FIAT 1.8 16v. and 2.0 / 2.4 20v. Twin Camshaft Petrol Engines

Engine timing and timing belt replacement applications on this range engines require the camshafts to be retained in their 'timed' positions by use of **Camshaft Setting Plates** which are fixed on the engine, in place of designated bearing caps, at specified cylinder locations.

The **AL - Fi** range of Universal Camshaft Setting Plates provides wide application coverage across engine ranges by utilising common **Support Blocks** – one for all Inlet camshafts, and one for all Exhaust camshafts. **Inter-changeable Setting Plates** are mounted on to these Support Blocks.

The position of the Setting Plates on the Support Blocks is adjustable in order to provide coverage of a range of engines.

The required **Setting Plate position** on the Support Block, is accurately achieved, and maintained, via the '**location pin**' which is inserted through a **numbered location hole** in the Support Block and **through a hole** in the Setting Plate. When mounted on the engine, this assembly fixes the **position of the camshaft lobe** to achieve correct camshaft timing position.

#### 4.5 Selecting the correct AL - Fi parts and assembling the Camshaft Setting Plate system for use.

##### 4.5.1 The Inlet Camshaft Setting Plate Assembly

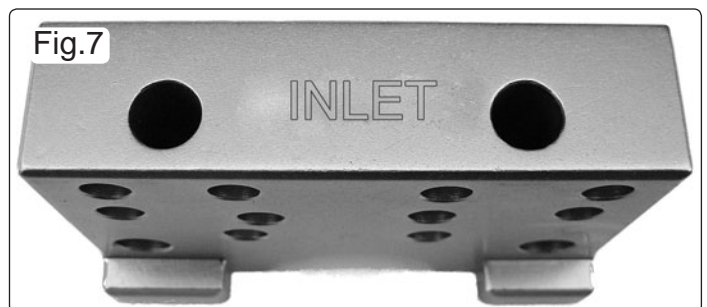

Select the "INLET" Support Block (Fig.7).

Fig.8

MODEL / engines		Plates / Pin Lo	
		INLET	
<b>ALFA ROMEO</b>			
<b>145 / 146</b>			
1.4 16v.TS (96-01)	335.03	A(5) + B(5)	C(4)
1.6 16v.TS (96-01)	676.01(to 0084340*)	A(5) + B(5)	C(4)
1.6 16v.TS (96-01)	676.01(from 0084340*)	A(4) + B(4)	C(2)
1.8 16v.TS (96-01)	322.01 / 671.06	A(6) + B(6)	C(3)
2.0 16v.TS (96-01)	323.01 / 672.04	A(6) + B(6)	C(3)
<b>147</b>			
1.6 16v.TS (105CV) (01-06)	372.03	A(3)	
1.6 16v.TS (120CV) (01-06)	321.0 / 321.04	A(4)	
2.0 16v.TS (01-06)	323.10	A(6)	
<b>155</b>			
1.6 16v.TS (96-97)	676.01	A(5) + L	
1.8 16v.TS (96-97)	671.06	A(5) + L	

Refer to Data Chart to establish which Setting Plates are required for the application. (Fig.8).

**Example:** Alfa Romeo 145 2.0 16v. TS (96-01) – Engine code 323.01  
= Plates “A” + “B”

Fig.11

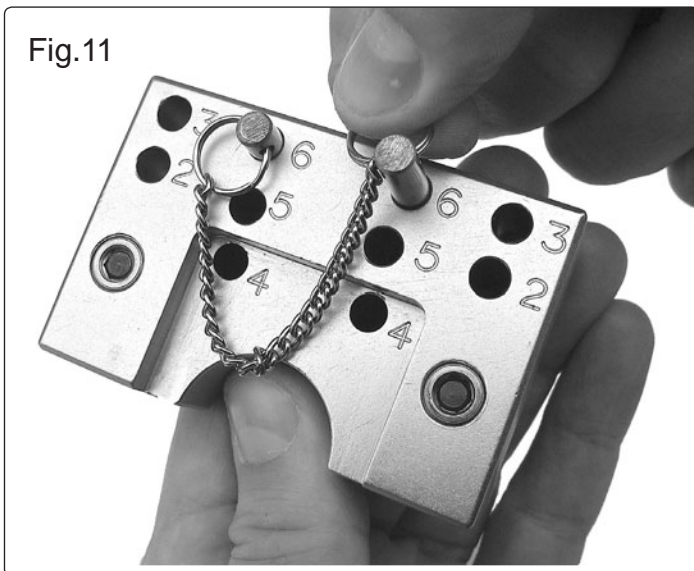

Select the Location Pins/Chain Assembly and pass the pins through the correct hole locations in the Support Block and through into the Setting Plates. (Fig.11).

Fig.9

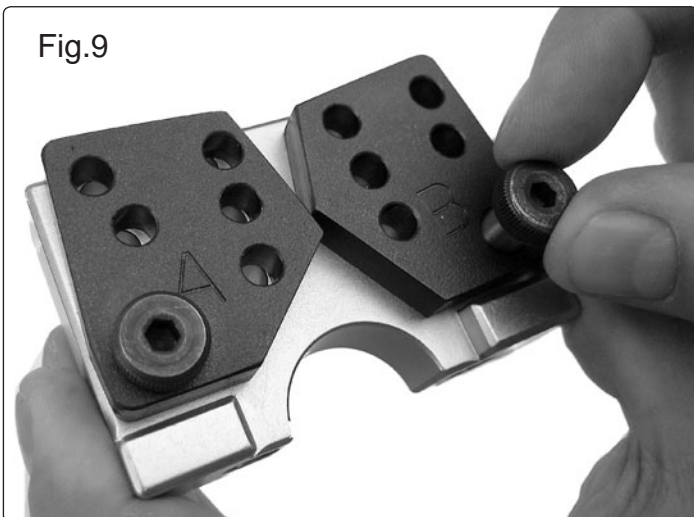

Fix the Setting Plates to the “INLET” Support Block with the securing screws (Fig.9). (Do not tighten fully at this stage).

**NOTE:** Plate “A” to the left and Plate “B” to the right, with the “A” & “B” lettering visible.

Fig.12

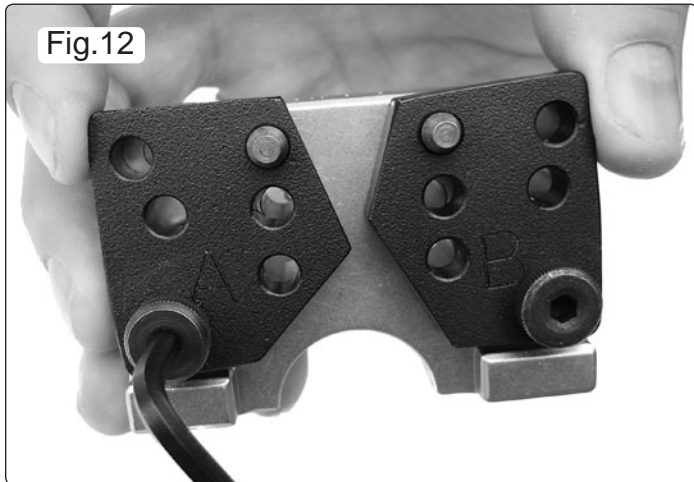

Retain the Location Pins in place by applying pressure to the sides of the Setting Plates whilst fully tightening the setting plate Securing Screws using the allen key provided in the kit. (Fig.12).

#### 4.5.2 The Exhaust Camshaft Setting Plate Assembly

Fig.10

MODEL / engines		Plates / Pin Lo	
		INLET	
<b>ALFA ROMEO</b>			
<b>145 / 146</b>			
1.4 16v.TS (96-01)	335.03	A(5) + B(5)	C(4)
1.6 16v.TS (96-01)	676.01(to 0084340*)	A(5) + B(5)	C(4)
1.6 16v.TS (96-01)	676.01(from 0084340*)	A(4) + B(4)	C(2)
1.8 16v.TS (96-01)	322.01 / 671.06	A(6) + B(6)	C(3)
2.0 16v.TS (96-01)	323.01 / 672.04	A(6) + B(6)	C(3)
<b>147</b>			
1.6 16v.TS (105CV) (01-06)	372.03	A(3)	
1.6 16v.TS (120CV) (01-06)	321.0 / 321.04	A(4)	
2.0 16v.TS (01-06)	323.10	A(6)	
<b>155</b>			
1.6 16v.TS (96-97)	676.01	A(5) + L	
1.8 16v.TS (96-97)	671.06	A(5) + L	

4.4.5 Refer to Data Chart to establish which location pin hole number is to be used for this application (Fig.10).

**Example:** Alfa Romeo 145 2.0 16v. TS (96-01) – Engine code 323.01:  
= Plate A location “6” and Plate B location “6”

Fig.13



4.5.1 Select the “EXHAUST” Support Block (Fig.13).

Fig.14

MODEL / engines		Plates / Pin Locations	
		INLET	EXHAUST
<b>ALFA ROMEO</b>			
<b>145 / 146</b>			
1.4 16v.TS (96-01)	335.03	A(5) + B(5)	C(4) + D(4)
1.6 16v.TS (96-01)	676.01(to 0084340*)	A(5) + B(5)	C(4) + D(4)
1.6 16v.TS (96-01)	676.01(from 0084340*)	A(4) + B(4)	C(2) + D(2)
1.8 16v.TS (96-01)	322.01 / 671.06	A(6) + B(6)	C(3) + D(3)
2.0 16v.TS (96-01)	323.01 / 672.04	A(6) + B(6)	C(3) + D(3)
<b>147</b>			
1.6 16v.TS (105CV) (01-06)	372.03	A(3) + B(3)	C(4) + D(4)
1.6 16v.TS (120CV) (01-06)	321.0 / 321.04	A(4) + B(4)	C(2) + D(2)
2.0 16v.TS (01-06)	323.10	A(6) + B(6)	C(3) + D(3)
<b>155</b>			
1.6 16v.TS (96-97)	676.01	A(5) + B(5)	C(4) + D(4)
1.8 16v.TS (96-97)	671.06	A(6) + B(6)	C(3) + D(3)
2.0 16v.TS (95-97)	672.04	A(6) + B(6)	C(3) + D(3)
<b>156</b>			
1.6 16v.TS (98-01)	321.02	A(4) + B(4)	C(2) + D(2)
1.6 16v.TS (99-06)	321.03 / 321.04	A(4) + B(4)	C(2) + D(2)

Refer to Data Chart to establish which Setting Plates are required for the application. (Fig.14).

**Example:** Alfa Romeo 145 2.0 16v. TS (96-01) – Engine code 323.01  
= Plates “C” + “D”

Fig.17

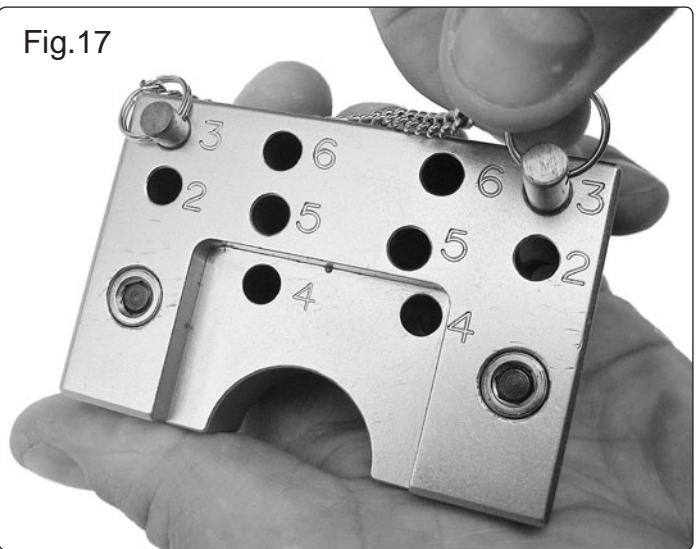

4.5.5 Select the Location Pins / Chain Assembly and pass the pins through the correct hole locations in the Support Block and through into the Setting Plates. (Fig.17).

Fig.15



Fix the Setting Plates to the “EXHAUST” Support Block with the securing screws (Do not tighten fully at this stage). (Fig.15).

**NOTE:** Plate “C” to the left and Plate “D” to the right, with the “C” & “D” lettering visible.

Fig.18

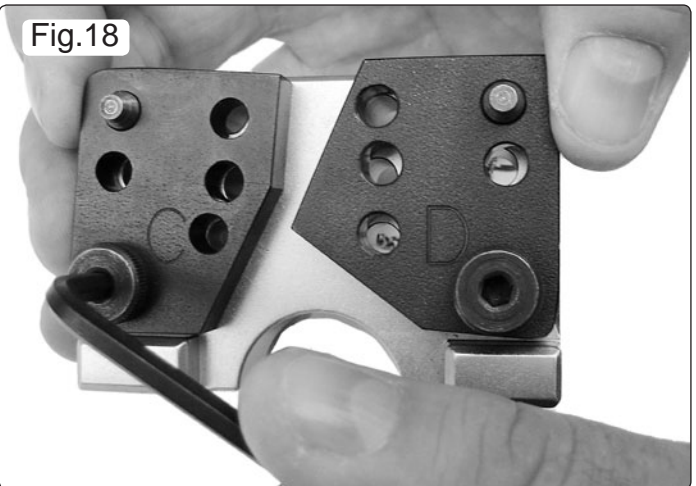

Retain the Location Pins in place by applying pressure to the sides of the Setting Plates whilst fully tightening the setting plate Securing Screws using the allen key provided in the kit. (Fig.18).

4.6 Fitting the AL-Fi Camshaft Setting Plate Sets to the engine  
Camshaft Setting Plate Assemblies are fixed in place of designated bearing caps, at specified cylinders. (Fig.18).

Fig.16

MODEL / engines		Plates / Pin Locations	
		INLET	EXHAUST
<b>ALFA ROMEO</b>			
<b>145 / 146</b>			
1.4 16v.TS (96-01)	335.03	A(5) + B(5)	C(4) + D(4)
1.6 16v.TS (96-01)	676.01(to 0084340*)	A(5) + B(5)	C(4) + D(4)
1.6 16v.TS (96-01)	676.01(from 0084340*)	A(4) + B(4)	C(2) + D(2)
1.8 16v.TS (96-01)	322.01 / 671.06	A(6) + B(6)	C(3) + D(3)
2.0 16v.TS (96-01)	323.01 / 672.04	A(6) + B(6)	C(3) + D(3)
<b>147</b>			
1.6 16v.TS (105CV) (01-06)	372.03	A(3) + B(3)	C(4) + D(4)
1.6 16v.TS (120CV) (01-06)	321.0 / 321.04	A(4) + B(4)	C(2) + D(2)
2.0 16v.TS (01-06)	323.10	A(6) + B(6)	C(3) + D(3)
<b>155</b>			
1.6 16v.TS (96-97)	676.01	A(5) + B(5)	C(4) + D(4)
1.8 16v.TS (96-97)	671.06	A(6) + B(6)	C(3) + D(3)
2.0 16v.TS (95-97)	672.04	A(6) + B(6)	C(3) + D(3)
<b>156</b>			
1.6 16v.TS (98-01)	321.02	A(4) + B(4)	C(2) + D(2)
1.6 16v.TS (99-06)	321.03 / 321.04	A(4) + B(4)	C(2) + D(2)
1.6 16v.TS (97-01)	676.01(to 0084340*)	A(5) + B(5)	C(4) + D(4)

Refer to Data Chart to establish which location pin hole number is to be used for this application (Fig.16).

**Example:** Alfa Romeo 145 2.0 16v. TS (96-01) – Engine code 323.01  
= Plate C – “location 3” and Plate D – “location 3”

**Fig.19**

Engines	Plates / Pin Locations		Cylinder No.Position		FIAT Punt 1.8 1 Brav 1.8 1 2.0 2 Mare 1.8 1 2.0 2
	INLET	EXHAUST	INLET	EXHAUST	
335.03	A(5) + B(5)	C(4) + D(4)	2	3	
6.01(to 0084340*)	A(5) + B(5)	C(4) + D(4)	2	3	
6.01(from 0084340*)	A(4) + B(4)	C(2) + D(2)	2	3	
322.01 / 671.06	A(6) + B(6)	C(3) + D(3)	2	3	
323.01 / 672.04	A(6) + B(6)	C(3) + D(3)	2	3	
1-06) 372.03	A(3) + B(3)	C(5) + D(5)	2	3	
1-06) 321.0 / 321.04	A(4) + B(4)	C(2) + D(2)	2	3	
323.10	A(6) + B(6)	C(3) + D(3)	2	3	
676.01	A(5) + B(5)	C(4) + D(4)	2	3	
671.06	A(6) + B(6)	C(3) + D(3)	2	3	
672.04	A(6) + B(6)	C(3) + D(3)	2	3	

**4.6.1** Refer to Data Chart to establish at which cylinder position the "INLET" and the "EXHAUST" Setting Plate Assemblies are to be fitted on to the camshafts for your model / engine. (Fig.19).

**Example:** Alfa Romeo 145 2.0 16v. TS (96-01) – Engine code 323.01  
 = Inlet – Cylinder No.2      Exhaust – Cylinder No.3

**4.7 For timing belt replacement applications with the old timing belt still in situ / engine timing correct:-**

With the crankshaft correctly positioned at TDC No.1 cylinder, the camshaft lobes should be in the correct timed position to accept the AL - Fi Setting Plate Assemblies

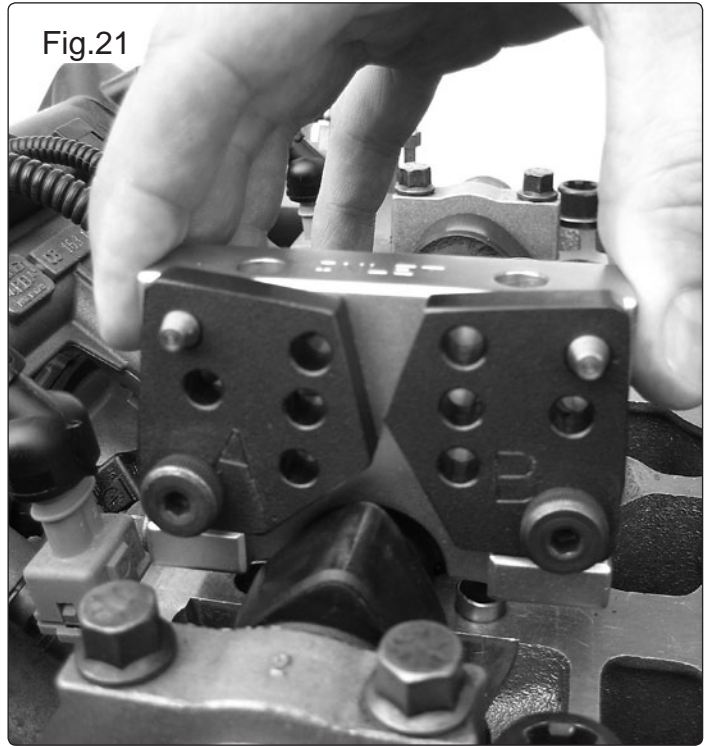

Place the Inlet and Exhaust AL - Fi Setting Plate Assemblies in position over the appropriate camshaft lobes. (Fig.21).

**IMPORTANT:** Ensure that the fixing holes in the Support Blocks match the offset bearing cap holes in the cylinder head. When viewed from the camshaft sprockets, the lettering on the Setting Plates should be visible.

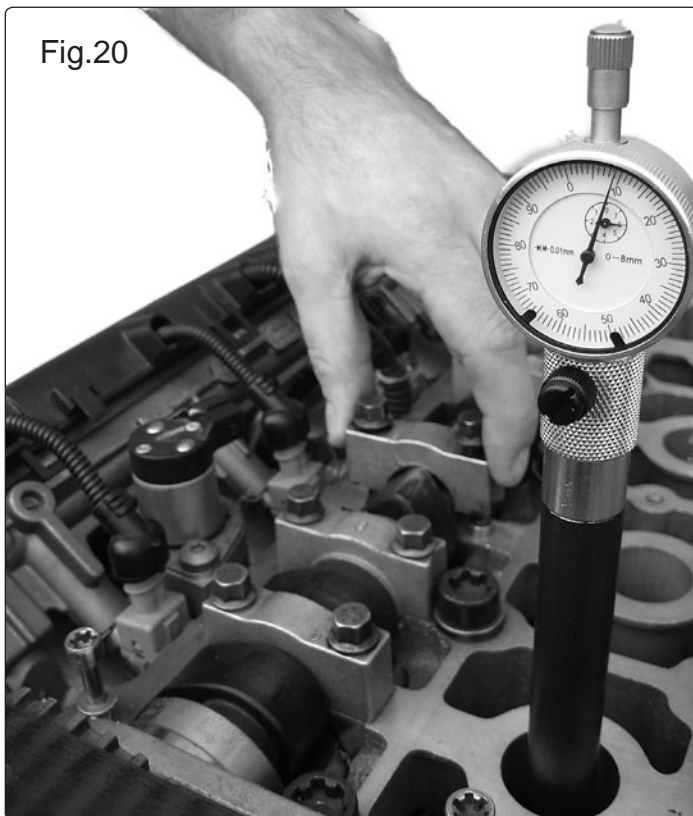

Remove the bearing cap of the inlet and exhaust camshafts at the appropriate cylinder locations. (Fig.20).

**NOTE:** Clearly mark which cap is inlet and which is exhaust, and keep clean at all times.

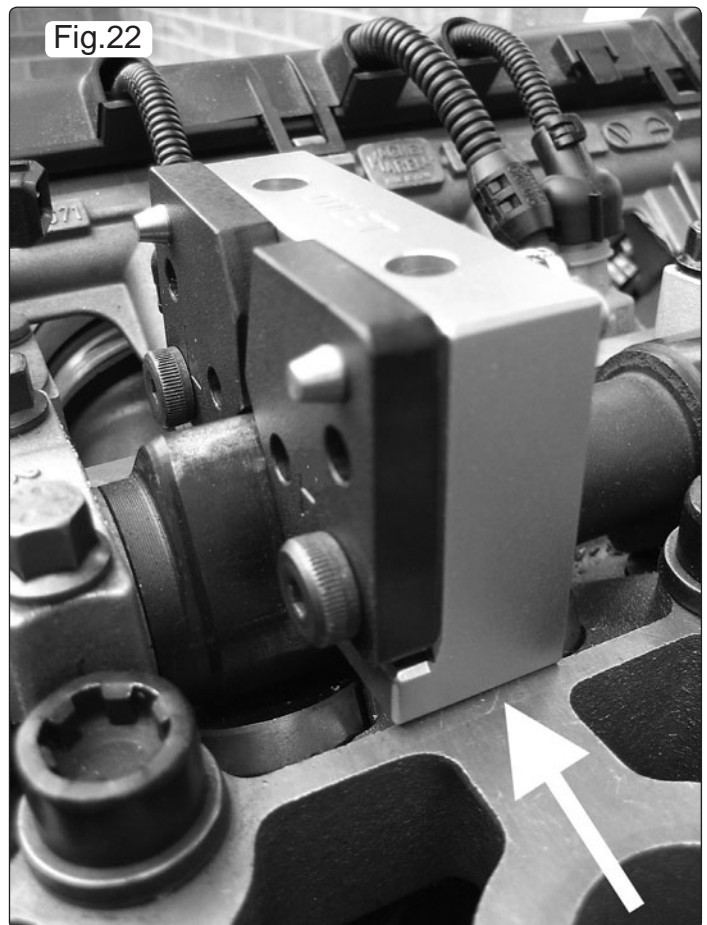

**CHECK THAT THE BASES OF THE SUPPORT BLOCKS REST ON THE SURFACE OF THE CYLINDER HEAD AND THAT THE SETTING PLATES ARE ALIGNED WITH THE PROFILE OF THE CAMSHAFT LOBES. (Fig. 22).**

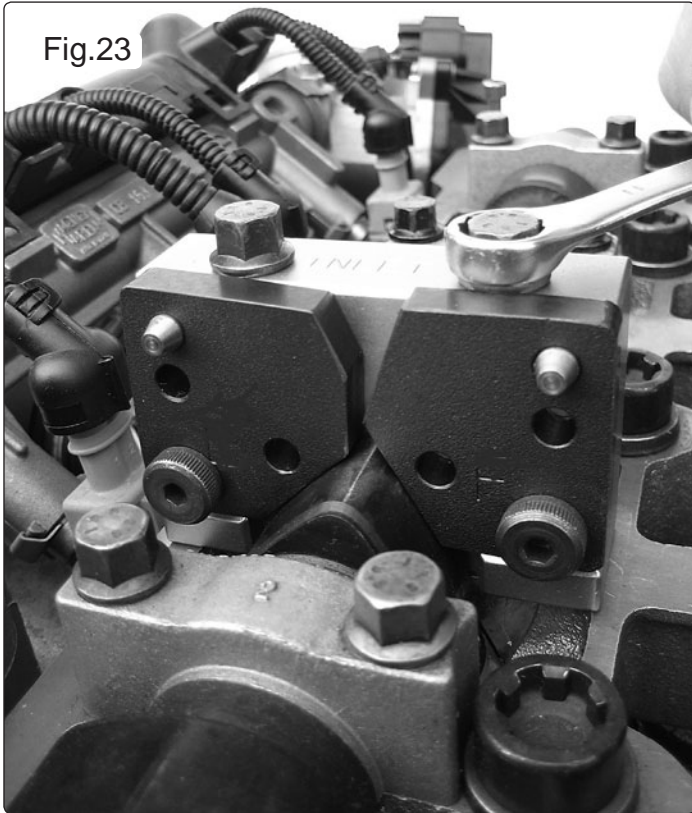

Fig.23

Insert the Flanged Securing Bolts (4) and tighten evenly to 10Nm. (Fig. 23).  
The belt tensioner can now be released and the old belt removed.

**WARNING: DO NOT use AL - Fi Camshaft Setting Plate Assemblies to counter-hold camshafts in position whilst releasing or tightening the sprocket bolts as this will damage the Setting Plates. AL - Fi Assemblies are for retention of timing position only. A Sprocket Holding Tool MUST BE used to counter-hold the sprockets.**

**NOTE:** These Alfa Romeo and Fiat timing belt applications require the camshaft sprockets to be 'free to turn' on the camshaft, when fitting the new timing belt, and therefore it is necessary to slacken the camshaft sprocket bolts. (Fig. 24).



Fig.24

#### 4.8 For camshaft timing applications (when timing belt not in place).

**AL - Fi Setting Plate Assemblies** can be used to 'set' the camshaft timing on these engines after engine overhaul or repair, and prior to installing a new belt.

The preparation involved in establishing the model/engines, selecting the appropriate **AL - Fi** parts to create the correct Camshaft Setting Plate Assemblies, and determining the correct cylinder location, is exactly the same as described earlier.

The appropriate cylinder locations should not have their camshaft bearing caps fit

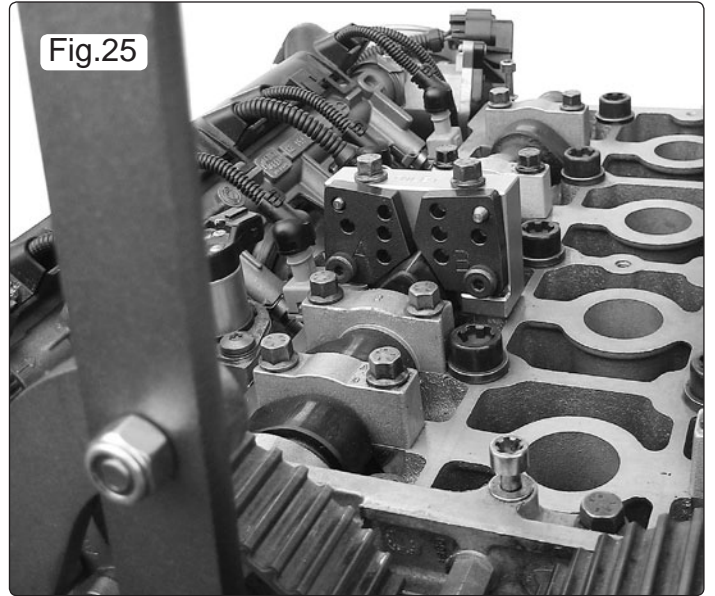
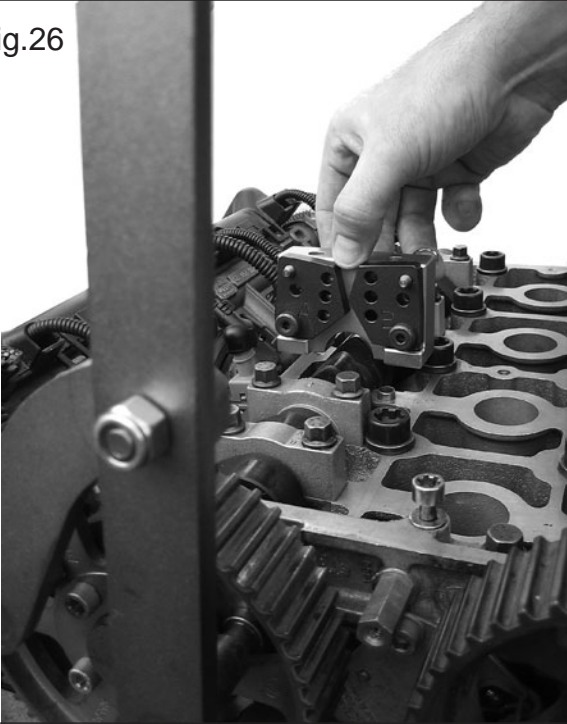

Fig.25

Look at the lobe profile form that has been created on the INLET **vv**Setting Plate Assembly and using a Sprocket Holding Tool on the camshaft sprockets, turn the INLET camshaft until the camshaft lobe at the appropriate cylinder location is approximately in the same orientation as the Setting Plate Assembly. (Fig.25).



Fig.26



Place the INLET AL - Fi Setting Plate Assembly in position over the appropriate camshaft lobe. (Fig.26).

**IMPORTANT:** Ensure that the fixing holes in the Support Blocks match the offset bearing cap holes in the cylinder head. When viewed from the camshaft sprockets, the lettering on the Setting Plates should be visible.

Fig.28

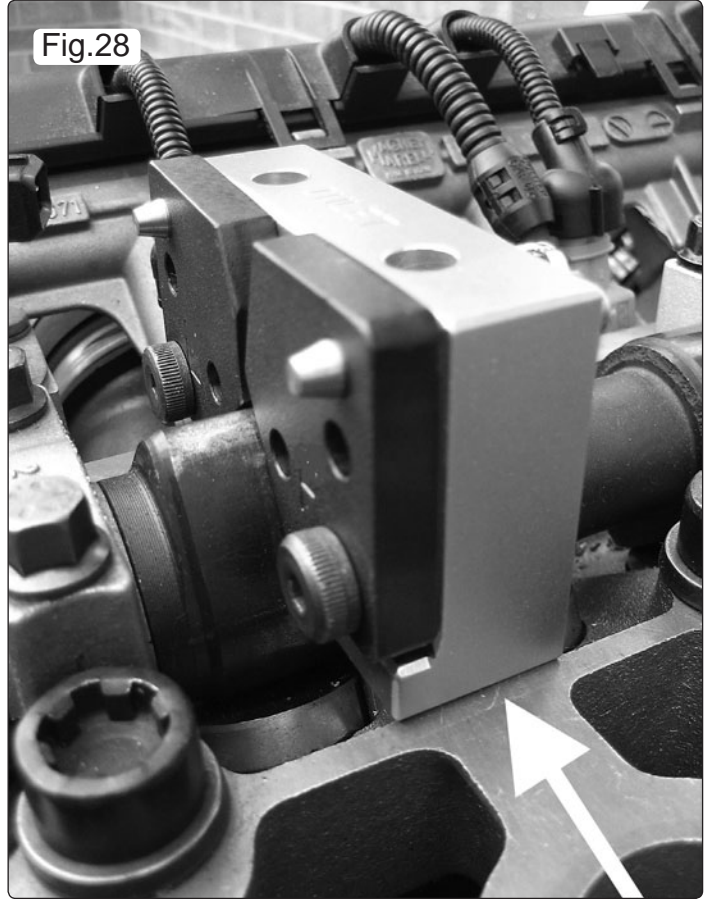

Whilst maintaining this position with the Holding Tool, **CHECK THAT THE BASE OF THE SUPPORT BLOCK RESTS ON THE SURFACE OF THE CYLINDER HEAD AND THAT THE SETTING PLATES ARE ALIGNED WITH THE PROFILE OF THE CAMSHAFT LOBES**, and insert the Flanged Securing Bolts (2). Tighten evenly to 10Nm. (Fig.28).

Repeat the same procedure with the Exhaust Setting Plate Assembly, mounting it on to the exhaust camshaft at the correct cylinder location.

**WARNING: DO NOT use AL - Fi Camshaft Setting Plate Assemblies to counter-hold camshafts in position whilst releasing or tightening the sprocket bolts as this will damage the Setting Plates. AL - Fi Assemblies are for retention of timing position only. A Sprocket Holding Tool MUST BE used to counter-hold the sprockets.**

When fitting the new timing belt the camshaft sprockets must be 'free to turn' on the camshaft and therefore it is necessary to slacken the camshaft sprocket bolts.

Fig.27



Using the Sprocket Holding Tool, make any final adjustment required to the camshaft position so the lobe aligns with the Setting Plates. (Fig.27).

**NOTE:** It is our policy to continually improve products and as such we reserve the right to alter data, specifications and component parts without prior notice.

**IMPORTANT:** No liability is accepted for incorrect use of product.

**WARRANTY:** Guarantee is 12 months from purchase date, proof of which will be required for any claim.

**INFORMATION:** For a copy of our latest catalogue and promotions call us on 01284 757525 and leave your full name and address, including postcode.



Sole UK Distributor  
Sealey Group,  
Bury St. Edmunds, Suffolk.



01284 757500



01284 703534



[www.sealey.co.uk](http://www.sealey.co.uk)



[sales@sealey.co.uk](mailto:sales@sealey.co.uk)