



INSTRUCTIONS FOR:
AUTOMATIC WELDING HELMET
Models: **SWH199, SWH299, & SWH399**

Thank you for purchasing a Sealey Power Product. Manufactured to a high standard this product will, if used according to these instructions and properly maintained, give you years of trouble free performance.

⚠ IMPORTANT: PLEASE READ THESE INSTRUCTIONS CAREFULLY. NOTE THE SAFE OPERATIONAL REQUIREMENTS, WARNINGS AND CAUTIONS. USE THIS PRODUCT CORRECTLY AND WITH CARE FOR THE PURPOSE FOR WHICH IT IS INTENDED. FAILURE TO DO SO MAY CAUSE DAMAGE OR PERSONAL INJURY, AND WILL INVALIDATE THE WARRANTY. PLEASE KEEP INSTRUCTIONS SAFE FOR FUTURE USE.

The SWH range of Automatic Welding Helmets come ready for use. Batteries are not necessary as operation is by means of Solar cells which automatically darken the eye shade cartridge when the arc is struck.

1. SAFETY INSTRUCTIONS

Ensure all workshop safety rules, regulations, and conditions are complied with when using welding equipment. The helmet will not offer protection against mis-use of workshop tools, equipment, or accessories. Maintain the helmet in good condition, and protect cartridge from liquid and dirt contact. Regularly replace the protective lenses and replace any damaged or worn parts. *Use genuine parts only. Non authorised parts may be dangerous and will invalidate the warranty.* NEVER open or tamper with the shade cartridge.

⚠ WARNING! *This helmet is not suitable for use with laser and gas-welding.* Ensure the front cover lens and front lens frame are securely in place before use. Fit the helmet and adjust the head band so the helmet will sit as low and near to your face as possible. Use helmet only in temperatures ranging from -10° C (+14°F) and + 70°C (+158°F). The eye protective plate in helmet is **NOT** unbreakable. Helmet will not protect you against severe impact hazards (*such as, but not limited to*) fragmenting abrasive discs/grinding wheels, stones and other grinding tools, explosive devices or corrosive fluids. The helmet will only protect the eyes and face from radiation and sparks. Remove ill fitting clothing, remove ties, watches, rings, and other loose jewellery. Maintain correct balance and footing. Ensure the floor is not slippery and wear non slip shoes. Keep children and unauthorised persons away from the working area.

⚠ WARNING! DO NOT use the helmet if damaged or you suspect it may be faulty. (Contact Service Agent). DO NOT use helmet unless you have been instructed in its use by a qualified person. DO NOT get the helmet wet or use in damp or wet locations. DO NOT leave work area with helmet in lowered position, as bright light source may darken cartridge unexpectedly. DO NOT place the helmet on a hot surface. Clean helmet (see chapter 5) and store the helmet in a safe, dry, childproof location.

▲ DANGER! *If, at any time, the face plate in the cartridge FAILS to darken when exposed to a welding spark, DO NOT USE. Remove cartridge and return to your dealer for service/inspection. Continued use of the product knowing that the auto darkening feature is not functioning may damage your eyes and cause blindness. Continued use of the helmet which is not functioning will invalidate the warranty and could prohibit a successful claim on any insurance policy.*

2. SPECIFICATIONS & TECHNICAL DATA

Type ModelSWH199 = Automatic 4/10
SWH299 = Automatic 4/10 4/11 with Manually adjust slide switch
SWH399 = Automatic 4/10-11 or 4/11-12
 Light transmittanceSWH199 = Visible range not activated: Shade level 4. Visible range activated: Shade level 10
SWH299 = Visible range not activated: Shade level 4. Visible range activated: Shade levels 10 or 11
SWH399 = Visible range not activated: Shade level 4. Visible range activated: Shade levels 10-11 or 11-12

Specifications common to All Models

Operating temperature (all models)-10° C (+14°F) and + 70°C (+158°F).
 Water-resistant (all models)Waterproof in accordance with IP67 (test duration 30min. depth 1 m / 3,28'
 Helmet material (all models)High-impact plastic, stability of shape up to 220°C / 428°F
 UV/IR protection (all cartridge states) (all models) =Maximum
 Response (light to dark @ room temp) (all models) =0.4ms
 Response (light to dark +55°C/131°F) (all models) =0.1ms
 Response (dark to light) (all models) =0.2 to 0.3 s
 Viewing area (all models)98 x 38mm (3.86 x 1.5")
 Cartridge size (all models) =90x110x7mm (3.54x4.33x0.28")
 Weight Helmet (all models) =460g
 Energy source (all models) =Solar cells
 Tig Welding (SWH399) =From 50amps

CE Declaration of Conformity We, the sole importer into the UK, declare that the products listed here are in conformity with the following EEC standards and directives. The construction files for these products are held by the Manufacturer and may be inspected on request by contacting Jack Sealey Ltd

Automatic Welding Helmet Models SWH199, SWH299, SWH399



Signed by Mark Sweetman  16th July 2003

For Jack Sealey Ltd. Sole importer into the UK of Sealey Power Products

BS EN 175:1997 BS EN 379:1994
BS EN 169:2002

NOTE: It is our policy to continually improve products and as such we reserve the right to alter data, specifications and component parts without prior notice.
IMPORTANT: No liability is accepted for incorrect use of this equipment. **WARRANTY:** Guarantee is 12 months from purchase date. proof of which will be required for any claim. **INFORMATION:** Call us for a copy of our latest catalogue on 01284 757525 and leave your full name and address including your postcode.

SEALEY POWER WELDERS Sole UK Distributor
Sealey Group, Bury St. Edmunds, Suffolk.

 01284 757500  01284 703534 **E-mail:** sales@sealey.co.uk

3. INSTRUCTIONS FOR USE

IMPORTANT: The quick response time of the helmet eye shade will protect your eyes from ultraviolet and infrared rays, regardless of the level the shade is set to. **⚠ WARNING! Before use, ensure that you have read and understood chapter 1. safety instructions.**

fig 1

3.1. Check that the front lens cover and frame are securely in place.

3.2. On models SWH299 and SWH399, use the switch (fig 1) to select the correct level of protection for your welding process according to following protection level lists.

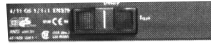

SWH199

No position setting required. Your mask is set to shade 10 protection.

SWH299

Protection level	Position
10 Automatic10
11 Automatic11
10 Perceived as too light	...11
11 perceived as too dark	...10
If the switch is defective	...10

SWH399

Protection level	Position
10-11 Automatic10-11
11-12 Automatic11-12
10-11 Perceived as too light	.11-12
11-12 perceived as too dark	.10-11
If the switch is defective 11

3.3. The time it will take for the shade to turn from light to dark and dark to light is set at 0.2 to 0.3 seconds. For full details see specifications.

3.4. Adjust the headband so the helmet is seated on the head as low as possible, and near your face (fig 2). Depress the headband ratchet knob at the rear (fig 3) until the headband and sweat band (fig 4) sit firmly in place, but not too tight.

3.5. When in lowest position, adjust angle of helmet by turning the angle knob (fig 5).

3.6. If necessary adjust the eye distance by loosening the locking knobs and adjusting so the shade is the same distance from both eyes. re-tighten the knobs. (fig 6).

3.7. You are now ready to use the helmet.

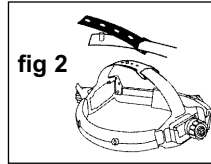

fig 3

fig 4

fig 5

fig 6

4. PROBLEM SOLVING

▲ DANGER! If, at any time, the face plate in the cartridge FAILS to darken when exposed to a welding spark, DO NOT USE. Remove cartridge and return to your dealer for checking. Continued use of the product with auto darkening feature NOT FUNCTIONING may DAMAGE YOUR EYES and CAUSE BLINDNESS. Knowingly continuing to use a product you are aware is malfunctioning will invalidate the warranty and any right of claim on any insurance policy.

IRREGULAR DARKENING OR DIMMING.	The headband may have been unevenly set on the two sides of the helmet (unequal distances from the eyes to the shade cartridge).	Readjust the distance of the shade.
SHADE CARTRIDGE DOES NOT DARKEN OR FLICKERS.	The sensors are soiled or obstructed. The sensor bar is tilted Front cover lens soiled or damaged. Welding current too low.	Clean Correct Clean or Replace Adjust welding current
POOR VISION	Operative lenses and/or shade cartridge soiled. Insufficient ambient light. Models SWH299/SWH399 Protection level incorrectly set.	Check clean or replace Illuminate work place Correct
SLOW RESPONSE	Operating temperature too low	do not use at temperatures below -10° C (+14°F)
WELDING HELMET SLIPS	Headband not adjusted correctly.	Lower helmet and refer to chapter 3.

5. MAINTENANCE

Replacing front cover lens.

Hold front lens frame at the bottom edge and pull up. Remove old lens and insert a new one. Snap the front lens frame into place at the top first then at the bottom. Press firmly into place (fig A).

fig A

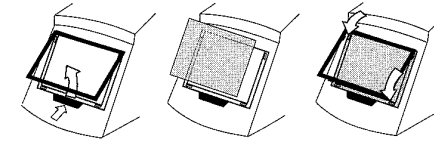
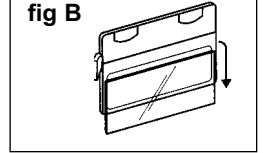

fig B



Replacing inside cover lens.

Lift lens with finger nail and then slide it out of the guideways. Replace with new lens (fig B).

Sweat Band

Regularly remove the sweat band wash and replace.

Sensor Bar

Pitch the bar downward and pull it out. Reverse the action to replace. (fig C).

fig C

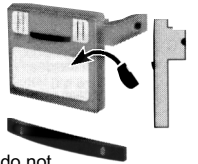

Changing the shade cartridge

Position the potentiometer control knob to number 9 and pull the knob out. Turn locking knobs and tilt shade cartridge out of place. Reverse procedure to insert new cartridge.

Cleaning

Clean the helmet by wiping with a soft clean cloth. Clean the cartridge surfaces regularly but do not use strong cleaning solutions.

Clean the sensors and solar cells with methylated spirit and a clean cloth and wipe dry with a lint-free cloth.

6. PARTS LIST & ASSEMBLY

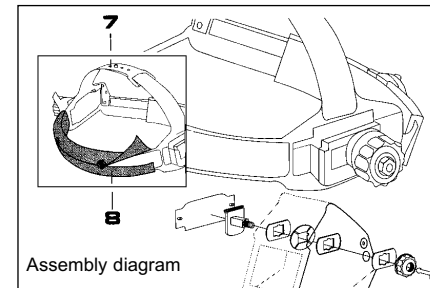

Assembly diagram

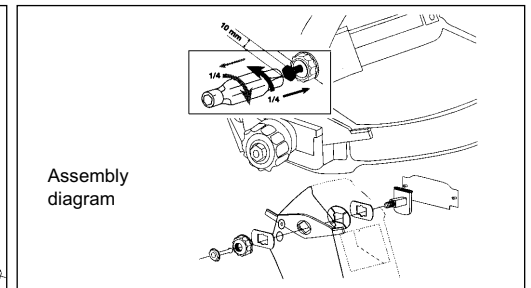

Assembly diagram

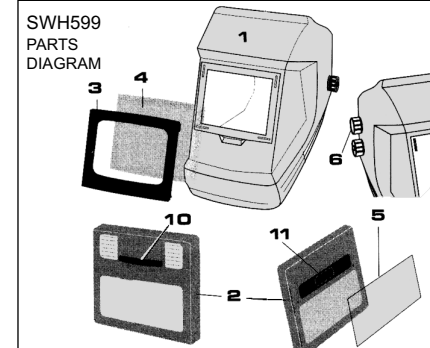

PARTS LIST

1. Welding mask
2. Shade cartridge
3. Front lens frame
4. Front cover lens
5. Inside cover lens for shade cartridge
6. Eccentric knob
7. Headband with fasteners
8. Sweat band
9. Slide switch for SWH299 & SWH399
10. Sensor bar