



## INSTRUCTIONS FOR

# WALL FAN 3-SPEED 16" WITH REMOTE CONTROL 230V

MODEL NO: **SWF16WR.V4**

Thank you for purchasing a Sealey product. Manufactured to a high standard, this product will, if used according to these instructions, and properly maintained, give you years of trouble free performance.

**IMPORTANT:** PLEASE READ THESE INSTRUCTIONS CAREFULLY. NOTE THE SAFE OPERATIONAL REQUIREMENTS, WARNINGS & CAUTIONS. USE THE PRODUCT CORRECTLY AND WITH CARE FOR THE PURPOSE FOR WHICH IT IS INTENDED. FAILURE TO DO SO MAY CAUSE DAMAGE AND/OR PERSONAL INJURY AND WILL INVALIDATE THE WARRANTY. KEEP THESE INSTRUCTIONS SAFE FOR FUTURE USE.



Refer to instructions

## 1. SAFETY

### 1.1. Electrical Safety

- ❑ **WARNING!** It is the user's responsibility to check the following:  
Check all electrical equipment and appliances to ensure that they are safe before using. Inspect power supply leads, plugs and all electrical connections for wear and damage. Sealey recommend that an RCD (Residual Current Device) is used with all electrical products. You may obtain an RCD by contacting your local Sealey dealer.  
if the used in the course of business duties, it must be maintained in a safe condition and routinely PAT (Portable Appliance Test) tested.
- ✓ Electrical safety information, it is important that the following information is read and understood.
- ✓ Ensure that the insulation on all cables and on the appliance is safe before connecting it to the power supply.
- ✓ Regularly inspect power supply cables and plugs for wear or damage and check all connections to ensure that they are secure.
- ✓ Ensure that the voltage rating on the appliance suits the power supply to be used and that the plug is fitted with the correct fuse - see fuse rating in these instructions.
- ✗ **DO NOT** pull or carry the appliance by the power cable.
- ✗ **DO NOT** pull the plug from the socket by the cable. Remove the plug from the socket by maintaining a firm grip on the plug.
- ✗ **DO NOT** use worn or damaged cables, plugs or connectors. Ensure that any faulty item is repaired or replaced immediately by a qualified electrician.

This product is fitted with a BS1363/A 13 Amp 3 pin plug.

If the cable or plug is damaged during use, switch off the electricity supply and remove from use.

Replace a damaged plug with a BS1363/A 13 Amp 3 pin plug. If in doubt contact a qualified electrician.

Class II products are wired with live (brown) and neutral (blue) only are marked with the Class II symbol; 

A) Connect the BROWN live wire to the live terminal 'L'.

B) Connect the BLUE neutral wire to the neutral terminal 'N'.

C) After wiring, check that there are no bare wires and ensure that all wires have been correctly connected.

Ensure that the cable outer sheath extends inside the cable restraint and that the restraint is tight.

**DO NOT** connect either wire to the earth terminal.

Sealey recommend that repairs are carried out by a qualified electrician.

### 1.2. General Safety

- ✓ Disconnect the fan from the mains power when not in use, and before servicing or performing any maintenance.
  - ✓ Use the fan in dry areas only. **DO NOT** use in wet or high condensation locations such as bathrooms, showers, or pools.
  - ❑ **WARNING!** If fan falls into water, immediately switch off and disconnect from the mains power supply. **DO NOT** touch the fan until the mains power supply has been disconnected.
  - ✓ Always disconnect the fan from the power supply when moving it from one location to another.
  - ✓ Keep the fan clean and maintained in good condition (use an authorised service agent).
  - ✓ Use recommended parts only (unauthorised parts may be dangerous, and will invalidate your warranty).
  - ✗ **DO NOT** insert any objects through the fan guard.
  - ✗ **DO NOT** cover the fan.
  - ✗ **DO NOT** immerse the fan in water or any other liquid.
  - ✗ **DO NOT** allow children to operate the fan.
  - ✗ **DO NOT** place the fan where it may be knocked over easily, or where the lead may cause a person to trip.
  - ✗ **DO NOT** use the fan outdoors.
  - ✗ **DO NOT** use an extension cord unless it has been approved by an electrical authority.
  - ✓ **When not in use store in a safe, dry, childproof location.**
- NOTE:** This appliance is not intended for use by persons (including children) with reduced physical, sensory or mental capabilities or lack of experience and knowledge, unless they have been given supervision or instruction concerning the use of the appliance by a person responsible for their safety. Children should be supervised to ensure that they do not play with the appliance.

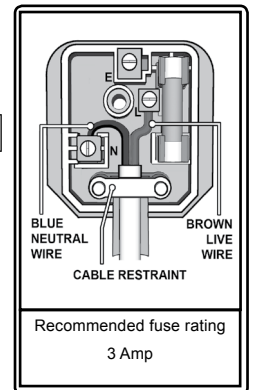

## 2. INTRODUCTION

Features tilt and swivel head for optimum air circulation. Remote control operation and fully guarded fan blades for ease of use and extra safety. Smooth running motor powers both fan blades and head oscillation. Timer function allows user to preset running time between 30 minutes - 7.5 hours. Sleep mode for gradual reduction of fan speed. Supplied with wall bracket for quick and easy installation.

## 3. SPECIFICATION

Model No:..... SWF16WR.V4  
 Fan Diameter: ..... 400mm  
 Speeds:..... 3  
 Oscillation: ..... Yes  
 Maximum Airflow: ..... 51.73mtr<sup>3</sup>/min  
 Power:..... 40W  
 Supply:..... 230V  
 Height: ..... 500mm

## 4. ASSEMBLY

### 4.1. Assembly

- 4.1.1. Remove the rear grill mounting nut by turning it counter-clockwise.
- 4.1.2. Place the rear grill onto the motor housing aligning the 3 raised knobs on the top of the motor housing with the three holes on the grill. fig.1.
- 4.1.3. Place the rear grill mounting nut over spindle and and tighten clockwise. fig.2.
- 4.1.4. Align the blade with the shaft and slide into position. Secure in position by tightening the blade knob counter-clockwise. fig.3.
- 4.1.5. Align the front grill with the rear grill and push the clips together to secure .

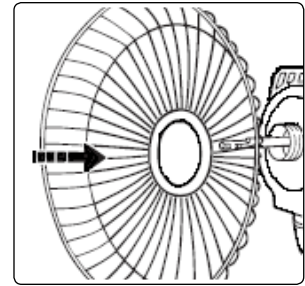

fig.1

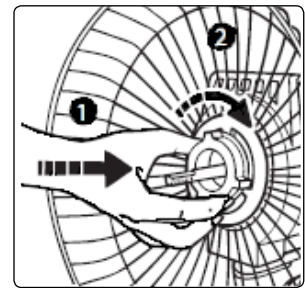

fig.2

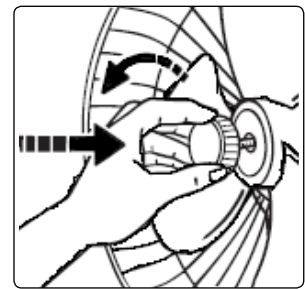

fig.3

### 4.2. Wall Mounting

- 4.2.1. Position the wall mounting bracket on the wall where the fan will be mounted. ensure the blades are move than 2.3 m above floor.
- 4.2.2. Use the bracket as a template and mark the two holes ready for drilling. fig.4.
- 4.2.3. Use either fixings supplied or proprietary wall fixings, ensure fixings chosen are suitable for the type of wall and the weight of the fan.
- 4.2.4. Drill two holes suitable for the wall fixings.
- 4.2.5. Attach bracket to wall.
- 4.2.6. Slide fan back plate over bracket to hang fan from wall.

### 4.3. Battery Installation

- 4.3.1. To use remote control, open the cover on the back of the remote control unit fig.5, and insert 2 x AAA batteries ensure they are correctly position according to polarity see diagram in battery compartment.

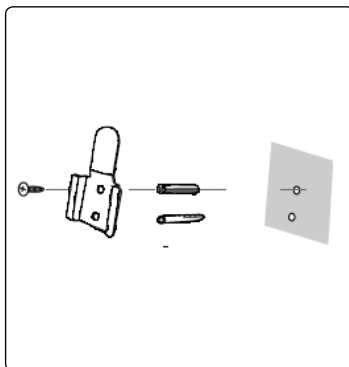

fig.4

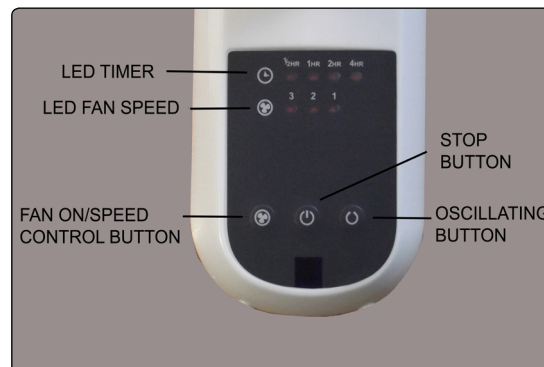

fig.6

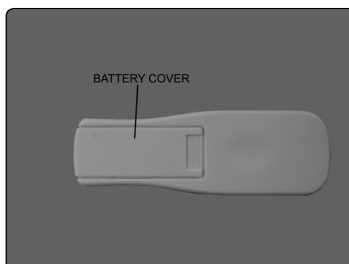

fig.5

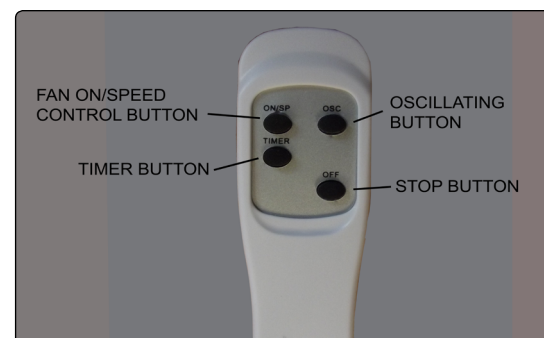

fig.7

## 5. OPERATION

- 5.1. Position the fan on a level and dry wall surface.
  - 5.2. Plug the power cable into the socket and switch on the power supply.
  - 5.3. **Fan control panel**
    - 5.3.1. LED TIMER :- Visual display of time setting can only be set from remote control. fig.6.
    - 5.3.2. LED FAN SPEED :- Visual display of speed. fig.6.
    - 5.3.3. FAN ON/SPEED CONTROL BUTTON :- Press to switch on, press again to scroll through speed settings. fig.6.
    - 5.3.4. OSCILLATING BUTTON :- Press to switch on oscillation, press again to switch off oscillation. fig.6.
    - 5.3.5. STOP BUTTON :- Switches fan off. fig.6.
  - 5.4. **Remote Control**
    - 5.4.1. FAN ON/SPEED CONTROL BUTTON :- Press to switch on, press again to scroll through speed settings. fig.7.
    - 5.4.2. OSCILLATING BUTTON :- Press to switch on oscillation, press again to switch off oscillation. fig.7.
    - 5.4.3. STOP BUTTON :- Switches fan off. fig.7.
    - 5.4.4. TIMER BUTTON :- Press to select working time, 1,2,4, or 7.5 hours indicated by the LED lights on the fan control panel (ie. by adding the selected fig. displayed above LED.) fig.7.
- Note: As the timer counts down the speed of the fan will reduce

## 6. CLEANING

- 6.1. Be sure your fan is in the OFF position.
- 6.2. Unplug the fan before cleaning.
- 6.3. Use only a soft, damp cloth to gently wipe the fan.
- 6.4. **DO NOT** immerse the fan in water and never allow water to enter the Motor Housing.
- 6.5. **DO NOT** use petrol, paint thinner or other chemicals to clean the fan.
- 6.6. To access the fan blade, remove the front grill and blade securing knob.
- 6.7. Clean the fan blade, front and rear grills with a soft, moist cloth.
- 6.8. Replace blade, tighten securing screw and securely fasten the front grill.

Parts support is available for this product. To obtain a parts listing and/or diagram, please log on to [www.sealey.co.uk](http://www.sealey.co.uk), email [sales@sealey.co.uk](mailto:sales@sealey.co.uk) or telephone 01284 757500.



### Environmental Protection

Recycle unwanted materials instead of disposing of them as waste. All tools, accessories and packaging should be sorted, taken to a recycling centre and disposed of in a manner which is compatible with the environment. When the product becomes completely unserviceable and requires disposal, drain off any fluids (if applicable) into approved containers and dispose of the product and the fluids according to local regulations.



### WEEE Regulations

Dispose of this product at the end of its working life in compliance with the EU Directive on Waste Electrical and Electronic Equipment (WEEE). When the product is no longer required, it must be disposed of in an environmentally protective way. Contact your local solid waste authority for recycling information.



### Battery Removal

See Section 4.3

Under the Waste Batteries and Accumulators Regulations 2009, Jack Sealey Ltd are required to inform potential purchasers of products containing batteries (as defined within these regulations), that they are registered with Valpak's registered compliance scheme. Jack Sealey Ltd's Batteries Producer Registration Number (BPRN) is BPRN00705.

**NOTE:** It is our policy to continually improve products and as such we reserve the right to alter data, specifications and component parts without prior notice.

**IMPORTANT:** No liability is accepted for incorrect use of this product.

**WARRANTY:** Guarantee is 12 months from purchase date, proof of which will be required for any claim.



Sole UK Distributor, Sealey Group.  
Kempson Way, Suffolk Business Park,  
Bury St. Edmunds, Suffolk.  
IP32 7AR



01284 757500



01284 703534



[www.sealey.co.uk](http://www.sealey.co.uk)



[sales@sealey.co.uk](mailto:sales@sealey.co.uk)