

SEALEY

6/12V 150A STARTER/15A AUTOMATIC BATTERY CHARGER & MAINTAINER

MODEL NO: SUPERBOOST150D

Thank you for purchasing a Sealey product. Manufactured to a high standard, this product will, if used according to these instructions, and properly maintained, give you years of trouble free performance.

IMPORTANT: PLEASE READ THESE INSTRUCTIONS CAREFULLY. NOTE THE SAFE OPERATIONAL REQUIREMENTS, WARNINGS & CAUTIONS. USE THE PRODUCT CORRECTLY AND WITH CARE FOR THE PURPOSE FOR WHICH IT IS INTENDED. FAILURE TO DO SO MAY CAUSE DAMAGE AND/OR PERSONAL INJURY AND WILL INVALIDATE THE WARRANTY. KEEP THESE INSTRUCTIONS SAFE FOR FUTURE USE.



Refer to instruction manual



Warning: explosive material



Wear eye protection



Warning: corrosive substance



Wear protective gloves



Warning: electricity



Protect from rain

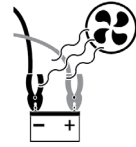

Use in well ventilated areas



Keep away from sources of ignition: battery could explode

1. SAFETY

1.1. ELECTRICAL SAFETY

- WARNING!** It is the user's responsibility to check the following:
Check all electrical equipment and appliances to ensure that they are safe before using. Inspect power supply leads, plugs and all electrical connections for wear and damage. Sealey recommend that an RCD (Residual Current Device) is used with all electrical products. You may obtain an RCD by contacting your local Sealey stockist.

If the product is used in the course of business duties, it must be maintained in a safe condition and routinely PAT (Portable Appliance Test) tested.

Electrical safety information, it is important that the following information is read and understood.

Ensure that the insulation on all cables and on the appliance is safe before connecting it to the power supply.

Regularly inspect power supply cables and plugs for wear or damage and check all connections to ensure that they are secure.

Important: Ensure that the voltage rating on the appliance suits the power supply to be used and that the plug is fitted with the correct fuse - see fuse rating in these instructions.

- ✗ **DO NOT** pull or carry the appliance by the power cable.
- ✗ **DO NOT** pull the plug from the socket by the cable.
- ✗ **DO NOT** use worn or damaged cables, plugs or connectors. Ensure that any faulty item is repaired or is replaced immediately by a qualified electrician.

This product is fitted with a BS1363/A 3 pin plug.

If the cable or plug is damaged during use, switch off the electricity supply and remove from use.

Ensure that repairs are carried out by a qualified electrician.

Replace a damaged plug with a BS1363/A 3 pin plug. If in doubt contact a qualified electrician.

a) Connect the GREEN/YELLOW earth wire to the earth terminal 'E'.

b) Connect the BROWN live wire to the live terminal 'L'.

c) Connect the BLUE neutral wire to the neutral terminal 'N'.

Ensure that the cable outer sheath extends inside the cable restraint and that the restraint is tight.

Sealey recommend that repairs are carried out by a qualified electrician.

1.2. GENERAL SAFETY

- ▲ **DANGER! BE AWARE, LEAD-ACID BATTERIES GENERATE EXPLOSIVE GASES DURING NORMAL BATTERY OPERATION. FOR THIS REASON, IT VERY IMPORTANT TO READ AND FOLLOW THESE INSTRUCTIONS CAREFULLY, EACH TIME YOU USE THE CHARGING EQUIPMENT.**

✓ Follow these instructions and those published by the battery and vehicle manufacturers, and the maker of any equipment you intend to use in the vicinity of the battery. Remember to review warning marks on all products and on engines.

- WARNING!** Modern vehicles contain extensive electronic systems.

You are required to check with the vehicle manufacturer, for any specific instructions regarding the use of this type of equipment on each vehicle.

✓ No liability will be accepted for damage / injury, where this product is not used in accordance with all instructions.

1.3. PERSONAL PRECAUTIONS

✓ Ensure there is another person within hearing range of your voice and close enough to come to your aid, should a problem arise when working near a lead-acid battery.

✓ Wear safety eye protection and protective clothing. Avoid touching eyes while working near battery.

✓ Have fresh water and soap nearby in case battery acid contacts skin, clothing or eyes.

✓ Wash immediately with soap and water if battery acid contacts skin or clothing. If acid enters eye, flush eye immediately with cool, clean running water for at least 15 minutes and seek immediate medical attention.

✓ Remove personal metallic items such as rings, bracelets, necklaces and watches. A lead-acid battery can produce a short-circuit current which is high enough to weld a ring or the like to metal, which would cause severe burns.

✓ Ensure hands, clothing (especially belts) are clear of fan blades and other moving or hot parts of engine, remove ties and contain long hair.

✗ **DO NOT** smoke or allow a spark or flame in the vicinity of battery or engine.

1.4. CHARGING SAFETY INSTRUCTIONS

✓ Familiarise yourself with the application and limitations of the charger as well as the potential hazards. Also refer to the vehicle manufacturer's hand book. IF IN ANY DOUBT CONSULT A QUALIFIED ELECTRICIAN.

✓ Ensure the charger is in good order and condition before use. If in any doubt do not use the unit, contact your Sealey stockist.

✓ Use the starter/charger in the horizontal position only and ensure it is placed on a stable surface which will adequately support its weight.

✓ Ensure the charger is disconnected from the mains supply before attaching/detaching the power clamps to/from the battery.

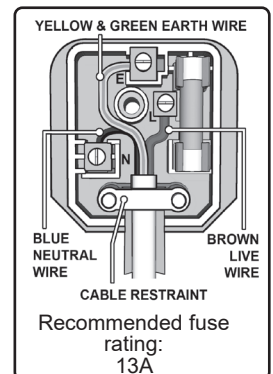

- ✓ Keep tools and other items away from the engine and ensure you can see the battery and working parts of engine clearly.
 - ✓ Ensure the output of the charger is the same voltage as the battery.
 - ✓ Ensure that during charging, the charger is placed in a location where there is sufficient ventilation to prevent the build up of explosive gases from a lead acid battery, and **DO NOT** cover or obstruct the charger ventilation louvres.
 - ✓ If battery has caps to access the battery fluid, remove the caps and check the fluid level before connecting the power clamps.
 - ✓ If necessary top-up the battery with distilled water by referring to the battery manufacturer's instructions (Apply the personal safety precautions described in part 1.3).
 - ✓ If the charger receives a sharp knock or blow the unit must be checked by a qualified service agent before using.
 - ✓ If the battery terminals are corroded or dirty clean them before attaching the power clamps.
 - ✓ Keep children and unauthorised persons away from the working area.
 - ✗ **DO NOT** dis-assemble the charger for any reason. The charger must only be checked by qualified service personnel.
 - ✗ **DO NOT** try to charge a non-rechargeable battery.
 - ✗ **DO NOT** try to charge battery if battery fluid is frozen.
 - ☐ **WARNING!** To prevent the risk of sparking, short circuit and possible explosion **DO NOT** drop metal tools in the battery area, or allow them to touch the battery terminals.
 - ✗ **DO NOT** allow power clamps to touch each other or to make contact with any metallic part of the vehicle.
 - ✗ **DO NOT** cross connect power leads from charger to battery. Ensure positive (+/RED) is to positive and negative (-/BLACK) is to negative.
 - ✗ **DO NOT** pull the cables or clamps from the battery terminals.
 - ✗ **DO NOT** use the charger outdoors, or in damp, or wet locations and **DO NOT** operate within the vicinity of flammable liquids or gases.
 - ✗ **DO NOT** use charger inside vehicle or inside engine compartment.
 - ✓ Ensure there is effective ventilation to prevent a build-up of explosive gases, and **DO NOT** cover or obstruct charger ventilation louvres.
 - ✗ **DO NOT** use the charger for a task for which it is not designed.
 - ☐ **WARNING! DO NOT** simultaneously charge batteries of different capacities or discharge levels.
 - ☐ **WARNING!** If a fuse blows, ensure it is replaced with an identical fuse type and rating. Use only Sealey genuine parts.
 - ✓ When not in use, store the charger carefully in a safe, dry, childproof location.
- This appliance can be used by children aged from 8 years and above and persons with reduced physical, sensory or mental capabilities or lack of experience and knowledge if they have been given supervision or instruction concerning use of the appliance in a safe way and understand the hazards involved. Children shall not play with the appliance. Cleaning and user maintenance shall not be made by children without supervision.

2. INTRODUCTION

Automatic battery charger & starter, designed for charging, maintaining, and boosting a variety of AGM (stop/start), GEL, lead acid and Lithium LiFePO4 batteries up to 300Ah. Intuitive digital display and 150A peak engine start function, makes this unit ideal for every workshop. Features overcharge, short circuit, and reverse polarity protection. Dedicated charging programs for AGM, GEL and conventional lead acid batteries with fully automated charging algorithms. Fast charge program for larger batteries. Automatic boost/engine start function once 12V mode is selected and battery voltage is over 4V. Portable design with carry handle and cable management system which allows the clips to be stored neatly away when not in use.

3. SPECIFICATION

Model No:	Superboost150D
Supply:	230V
Output Charge:	2A@6V, 2A(L)/15A(H)@12V (15A LiFePO4)
Start Current:	12V - 75A @ 7V
Peak Current:	150A
Battery Range:	30-300Ah
Cable & Clamp Length:	1.2m
Insulation Class:	IP20

4. OPERATION

4.1. DISPLAY

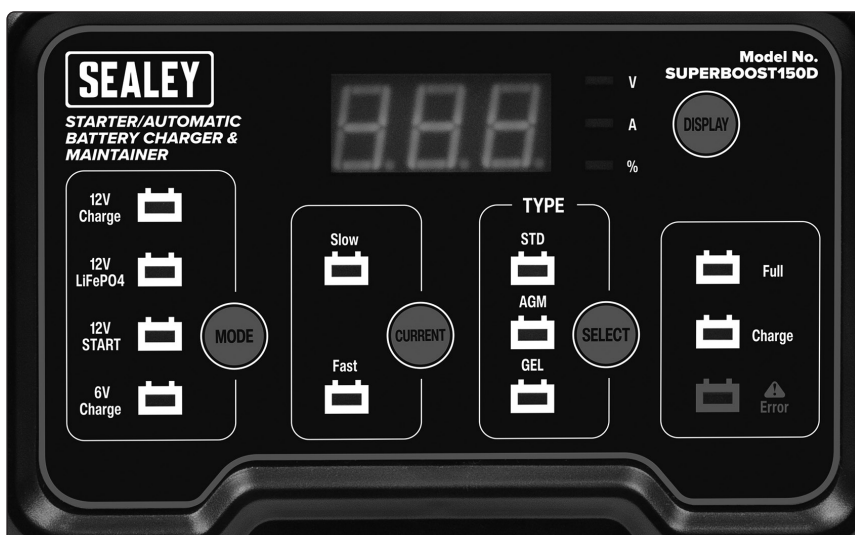

4.2. **HOW TO CONNECT**

4.2.1. The charger's output leads have colour-coded battery clips (RED-POSITIVE and BLACK-NEGATIVE). Determine which post of battery is grounded (connected) to the chassis.

4.3. **OPERATING INSTRUCTIONS: CHARGING BATTERY IN VEHICLE**

4.3.1. **If negative post is grounded to chassis (as in most vehicles):**

Connect the red clamp to the battery's positive pole.
Connect the black clamp to the vehicle chassis remote from the fuel pipe and the battery.
Connect the charger to mains supply.

4.3.2. **If positive post is grounded to the chassis:**

Connect the black clamp to the battery's negative pole.
Connect the red clamp to the vehicle chassis remote from the fuel pipe and the battery.
Connect the charger to mains supply.

4.3.3. When disconnecting charger, first disconnect from mains supply, remove clamp from vehicle chassis, and then remove clamp from the battery terminal.

× **DO NOT** charge the battery whilst engine is running.

4.4. **CHARGING**

STEP 1: Connect the battery and mains supply. The display shows the battery's voltage.

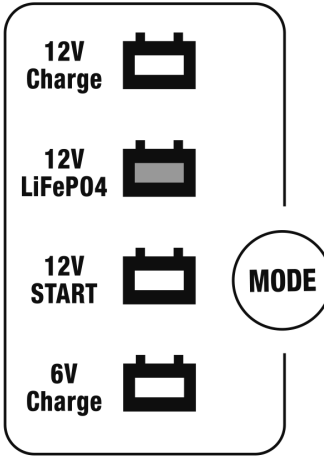

STEP 2: Press "MODE" button To select charging voltage (6V/12V) (orange light, except 12V START).

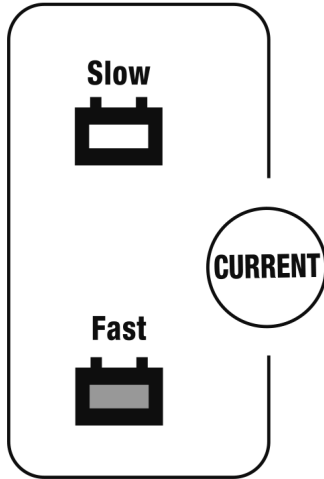

STEP 3: Press "CURRENT" button to select "Slow" or "Fast" charging current ("Slow"-green light, "Fast"-red light) (6V/2A, 12V 2A/15A). If you choose 12V LiFePO4 in STEP 2, the default current will be "Fast". You don't need to select charging current and battery type.

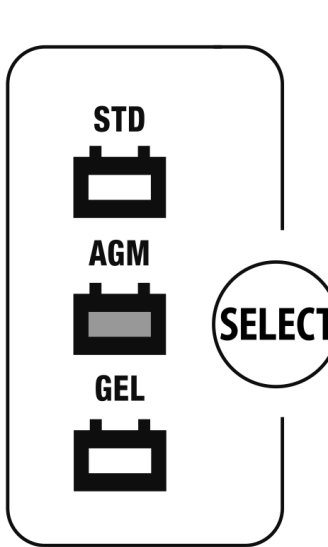

STEP 4: Press "SELECT" button To select battery type (STD / AGM / GEL) (orange light).

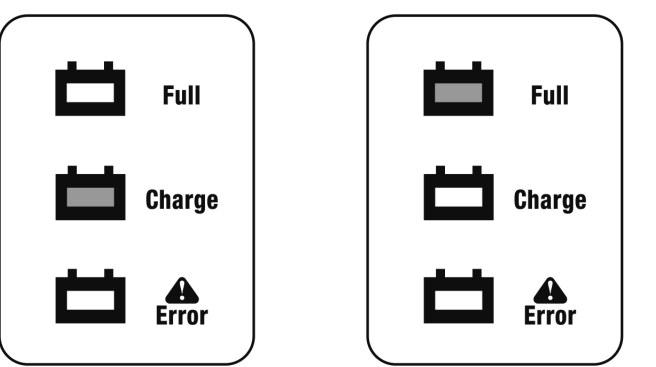

STEP 5: The charger starts to charge the battery automatically and the "Charge" light turns orange. When the battery is fully charged the "Full" light turns green.

Note: During charging, the display defaults to show voltage. Press "DISPLAY" button, switching "V" to "A" or "%" to show charging current or battery charged percentage.

• V = charging voltage • A = charging current • % = battery charge condition

4.4.1. To stop charging, disconnect mains plug or remove clamp from battery terminal.

4.5. HOW TO BOOST

STEP 1: Connect the battery and mains supply. The display shows the battery's voltage.

12V Charge

12V LiFePO4

12V START

6V Charge

MODE

STEP 2: Press "MODE" button to select 12V START (orange light).

STEP 3: The charger starts to charge the battery automatically. When the charger detects that the battery voltage is over 4V, it will automatically enter the startup Program (charge the battery and wait for The startup signal). As long as the user starts ignition, the product will provide the startup current and start the vehicle.

Note: The maximum of boosting time is 5 seconds and after each boost, it takes 180 seconds to cool down.

5. TROUBLESHOOTING

Problem	Cause	Solution
Error light turns red and buzzer sounds	Clamps are reverse connected	Connect clamps correctly
	Battery voltage is less than 1V	Check clamps are correctly connected or replace battery
	6V selected for 12V battery	Change to 12V mode
During the charging/starting process, the display Automatically returns to standby condition and displays the battery voltage	Charger is over temperature	Switch off machine and allow to cool
	The clamps are loose	Check connections
	The output is short circuited	Connect clamps correctly



ENVIRONMENT PROTECTION

Recycle unwanted materials instead of disposing of them as waste. All tools, accessories and packaging should be sorted, taken to a recycling centre and disposed of in a manner which is compatible with the environment. When the product becomes completely unserviceable and requires disposal, drain any fluids (if applicable) into approved containers and dispose of the product and fluids according to local regulations.



REGISTER YOUR PURCHASE HERE



WEEE REGULATIONS

Dispose of this product at the end of its working life in compliance with the EU Directive on Waste Electrical and Electronic Equipment (WEEE). When the product is no longer required, it must be disposed of in an environmentally protective way. Contact your local solid waste authority for recycling information.

Note: It is our policy to continually improve products and as such we reserve the right to alter data, specifications and component parts without prior notice.

Important: No Liability is accepted for incorrect use of this product.

Warranty: Guarantee is 12 months from purchase date, proof of which is required for any claim.

Sealey Group, Kempson Way, Suffolk Business Park, Bury St Edmunds, Suffolk. IP32 7AR



01284 757500



sales@sealey.co.uk



www.sealey.co.uk