

Thank you for purchasing a Sealey product. Manufactured to a high standard this product will, if used according to these instructions and properly maintained, give you years of trouble free performance.



IMPORTANT

PLEASE READ THESE INSTRUCTIONS CAREFULLY. NOTE THE SAFE OPERATIONAL REQUIREMENTS, WARNINGS AND CAUTIONS. USE THIS PRODUCT CORRECTLY AND WITH CARE FOR THE PURPOSE FOR WHICH IT IS INTENDED. FAILURE TO DO SO MAY CAUSE DAMAGE OR PERSONAL INJURY, AND WILL INVALIDATE THE WARRANTY. RETAIN THESE INSTRUCTIONS FOR FUTURE USE.

1. SAFETY INSTRUCTIONS

1.1. ELECTRICAL SAFETY. p WARNING! It is the user's responsibility to read, understand and comply with the following:

You must check all electrical equipment and appliances to ensure they are safe before using. You must inspect power supply leads, plugs and all electrical connections for wear and damage. You must ensure the risk of electric shock is minimised by the installation of appropriate safety devices. An RCCB (Residual Current Circuit Breaker) should be incorporated in the main distribution board. We also recommend that an RCD (Residual Current Device) is used with all electrical products. It is particularly important to use an RCD together with portable products that are plugged into an electrical supply not protected by an RCCB. If in doubt consult a professional electrician. You may obtain a Residual Current Device by contacting your Sealey dealer. **You must** also read and understand the following instructions concerning electrical safety.

- 1.1.1. The **Electricity At Work Act 1989** requires all portable electrical appliances, if used on business premises, to be tested by a qualified Electrician at least once a year by using a Portable Appliance Tester (PAT).
- 1.1.2. The **Health & Safety at Work Act 1974** makes owners of electrical appliances responsible for the safe condition of the appliance, and the safety of the appliance operator. **If in doubt about electrical safety, contact a qualified electrician.**
- 1.1.3. Ensure the insulation on all cables and the product itself is safe before connecting to the mains power supply. See 1.1.1. & 1.1.2. above and use a Portable Appliance Tester (PAT).
- 1.1.4. Ensure that cables are always protected against short circuit and overload.
- 1.1.5. Regularly inspect power supply, leads, plugs and all electrical connections for wear and damage, especially power connections, to ensure that none are loose.
- 1.1.6. **Important:** Ensure the voltage marked on the product is the same as the electrical power supply to be used, and check that plugs are fitted with the correct capacity fuse. A 13Amp plug may require a fuse smaller than 13Amps for certain products (*subject to 1.1.10. below*) see fuse rating at right.
- 1.1.7. DO NOT pull or carry the powered appliance by its power supply lead.
- 1.1.8. DO NOT pull power plugs from sockets by the power cable.
- 1.1.9. DO NOT use worn or damage leads, plugs or connections. Immediately replace or have repaired by a qualified Electrician. A U.K. 3 pin plug with ASTA/BS approval is fitted. In case of damage, cut off and fit a new plug according to the following instructions (discard old plug safely).

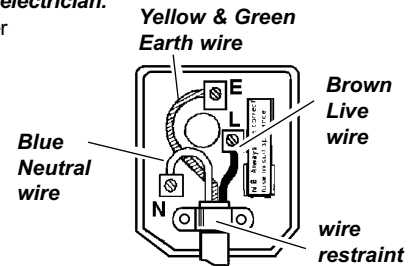

FUSE RATING
THIS PRODUCT MUST BE FITTED
WITH A:
5 Amp FUSE

(UK only - see diagram at right). **Ensure the unit is correctly earthed via a three-pin plug.**

- a) **Connect the GREEN/YELLOW earth wire to the earth terminal 'E'.**
- b) **Connect the BROWN live wire to live terminal 'L'.**
- c) **Connect the BLUE neutral wire to the neutral terminal 'N'.**

After wiring, check there are no bare wires, that all wires have been correctly connected and that the wire restraint is tight.

Double insulated products are often fitted with live (BROWN) and neutral (BLUE) wires only. Double insulated products are always marked with this symbol . **To re-wire, connect the brown & blue wires as indicated above. DO NOT connect the brown or blue to the earth terminal.**

- 1.1.10. **Cable extension reels.** When a cable extension reel is used it should be fully unwound before connection. A cable reel with an RCD fitted is recommended since any product which is plugged into the cable reel will be protected. The section of the cable on the cable reel is important. We recommend that at least 1.5mm² section cable but to be absolutely sure that the capacity of the cable reel is suitable for this product and for others that may be used in the other output sockets, we recommend the use of 2.5mm² section cable.

1.2 GENERAL SAFETY

- 3 Disconnect the drill from the mains power before changing accessories, servicing or performing any maintenance.
- 3 Maintain the drill in good condition. Check moving parts alignment, and keep drill bits sharp. If necessary use an authorised service agent.
- 3 Replace or repair damaged parts. *Use genuine parts only. Non authorised parts may be dangerous and will invalidate the warranty.*
- 3 Keep the drill clean for best and safest performance. Keep the ventilation slots clear.
- 3 Wear approved safety eye and ear protection and if dust is generated a dust mask. Rubber gloves are recommended when using outdoors, and safety gloves when drilling items such as steel, brick work etc. Ensure you only hold the drill by the plastic handles.
- 3 Remove ill fitting clothing. Remove ties, watches, rings, and other loose jewellery, and contain long hair.
- 3 Use drill in an adequate working area for its function, keep area clean and tidy and free from unrelated materials. Ensure good lighting.
- 3 Prevent body contact with grounded surfaces to avoid electric shock i.e. pipes, radiators, range, refrigerators etc.
- 3 Evaluate your working area before using the drill i.e. ceiling, floors and enclosures may contain hidden electrical items or water piping.
- 3 Prolonged exposure to vibration from the drill poses a health risk. It is the operator's responsibility to correctly assess the potential hazard and follow/issue guidelines for safe periods of use and use/offer suitable protective equipment.
- 3 The side handle should always be attached for use. When the standard chuck is used, ensure the key is removed before starting the drill.
- 3 Maintain correct balance and footing. Ensure the floor is not slippery and wear non slip shoes.
- 3 Keep children and non essential persons away from the working area.
- 3 Use correctly rated drill and chisel bits, with the the correct connection type.
- 3 Secure non stable work piece with a clamp, vice or other adequate holding device.
- 7 DO NOT force drill to achieve a task its not designed for.
- 7 DO NOT operate drill where there are flammable liquids or gases.
- 7 DO NOT use drill if parts are damaged or missing as this may cause failure and/or personal injury.
- 7 DO NOT get the drill wet or use in damp or wet locations.
- 7 DO NOT hold unsecured work in your hand and avoid unintentional starting.
- 7 DO NOT leave the drill running whilst unattended.
- 7 DO NOT carry the drill with your finger on the power switch.
- 7 DO NOT use drill when you are tired, under the influence of alcohol, drugs or intoxicating medication.
- 3 When not in use switch drill off, remove power plug, clean and store in carry case and place a in safe, dry, child proof location.

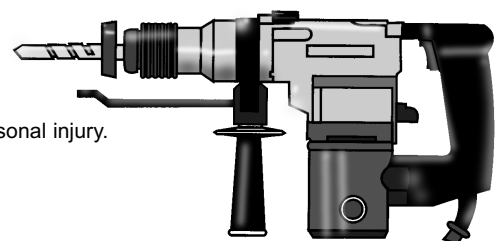

2. INTRODUCTION & SPECIFICATIONS

The SDS620 is equipped with SDS drill bit locking system to enable easy assembly and to hold bits safely in place while working. The drill has three separate functions. 1. To drill without hammer action. 2. To drill with hammer action. 3. Hammer action only. The drill also has a standard chuck that may be used for more conventional tasks.

COMMON TO MODELS SDE600

Input power	620W
Power supply	.230 Volt
Conventional Drill chuck capacity	13mm
Speed at no load	750rpm
Hammer action	2920min
Maximum capacity for steel	16mm
Maximum capacity for concrete	26mm
Maximum capacity for wood	40mm
Approx weight (with drill-holder)	5.4kg
Noise level Maximum	.98dB (A)
Vibration level	.27m/s ²

COMPONENT LIST Figure 1.

1. Drill bit	6. Stop bar
2. Dust cup	7. Rotation selector switch
3. Spindle lock	8. Hammer selector switch
4. Handle collar	9. On/Off trigger
5. Handle	10. Brush cover

fig 1

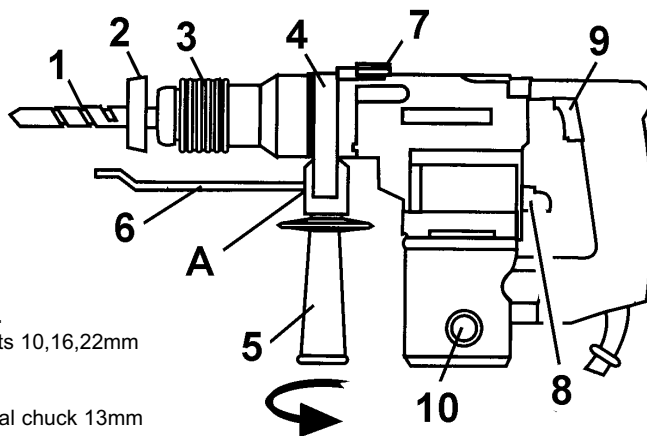

Items not illustrated.
 3 x SDS drill bits 10,16,22mm
 1 x Point chisel
 1 x Flat chisel
 1 x Conventional chuck 13mm
 1 x Chuck key
 1 x Chuck spindle
 1 x Chuck locking screw
 1 x Tub of grease

fig 2

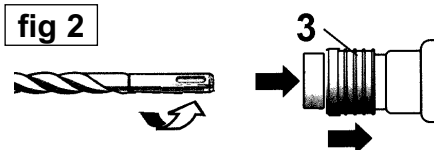
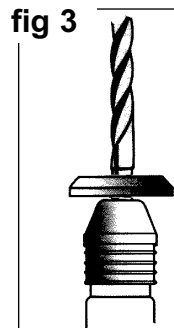

fig 3



3. INSTRUCTIONS FOR USE

3.1. PREPARING DRILL FOR USE.

WARNING! Unplug from the mains power supply before proceeding.

- 3.1.1. The side handle (fig 1.5) may be placed at various angles around the drill collar in order to reduce fatigue. and gain greater control over drill. To reposition handle, loosen by unscrewing anti-clockwise. Swivel handle to required angle and lock by screwing clockwise. Check that collar (4) is tight and the does not move.
- 3.1.2. Select drill bit (drill or chisel) for the task. Check that it is clean and sharp. Lightly lubricate the bit, pull drill spindle lock (fig 2.3) back and hold. Insert bit into the spindle carrier and turn the bit until it locks into position. Release spindle lock (3) and check bit is firmly held in place. To remove bit, reverse this process.
- 3.1.3. The dust cup (fig 3) will stop a proportion of dust generated from entering directly into the drill. Cup is especially important to use if drilling in a vertical position. To use the dust cup, slip the cup onto the bit shaft. Ensure the cup bowl shape is facing toward the sharp end of the bit and attache the bit to the drill.
- 3.1.4. To fit the depth gauge (fig 1.6), unscrew handle (5) until the assembly hole in the front of handle (fig1.A) has opened enough to push the stop bar through. Set the stop at the required depth and screw handle clockwise to lock the collar and depth stop in place.
 Note: The distance set between the end of depth stop and the end of drill will determine how deep the hole will be.

3.2. OPERATING THE DRILL

The drill has three operational modes which may be selected as follows.

- 3.2.1. **Drill without hammer action.**
 Position hammer selector switch (fig 4.7) so that it points to drill bit and hammer, and drill switch (4.8) to single drill bit embossed on case.
- 3.2.2. **Drill with hammer action.**
 Position both switches (fig 5.item 7 & 8) so they both point towards the drill bit and hammer.
- 3.2.3. **Hammer action only (For use with a chisel)**
 Position switch (fig 6.7) so it points to the hammer only, and switch (fig 6.8) to symbol of drill bit and hammer.
- 3.2.4. Plug drill in and switch on the mains power supply. Depress trigger (fig 1. 9) to activate the drill. Release trigger to stop the drill.

fig 4

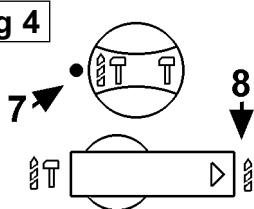

fig 5

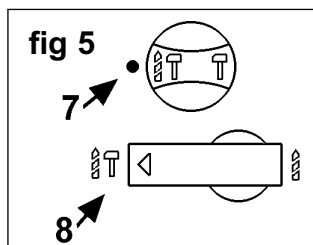

fig 6

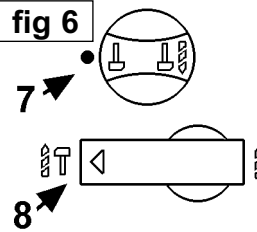
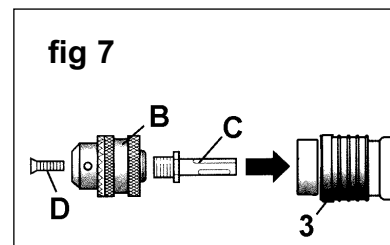

fig 7



3.3. CONVENTIONAL DRILL CHUCK

WARNING! Unplug from the mains power supply before assembling chuck.

- 3.3.1. Fit the conventional drill chuck (fig 7. B) by screwing it onto chuck spindle (C). Open chuck jaws and lock the chuck with screw (D).
 NOTE: The screw has a left-hand thread and must be turned anti-clockwise to tighten.
- 3.3.2. Fit the chuck spindle (C) into the spindle lock (3) in the same manner as part 3.1.2.
- 3.3.3. Fit the drill bit between the three chuck jaws and fully tighten with chuck key. Check that the drill is centrally located.

WARNING! ensure you remove the chuck key before starting the drill.

CAUTION! To avoid overloading the motor. When using the chuck in the hammer mode, DO NOT apply a too heavy pressure. DO NOT USE CHISELS OR 'HAMMER' MODE ONLY when using the conventional chuck, as chuck will be damaged.

4. INSTRUCTIONS FOR APPLICATION

⚠ WARNING! ensure you wear approved safety goggles and any other safety item required for the job. If using conventional chuck, remove the chuck key before using the drill. Also ensure that all other safety requirements are followed.

⚠ WARNING! In all cases below, be prepared for drill binding or break through. When these situations occur the drill has a tendency to grab and kick in the opposite direction and could cause loss of control. If you are not prepared this can result in possible damage and/or personal injury. Where possible, place a wooden block under metal work piece at the point where the drill will break through.

4.1. DRILLING MASONRY, BRICK, STONE, ROCK OR CONCRETE.

The hammer action can be used if required on brick, stone, rock or concrete.

- 4.1.1. Ensure drill is unplugged from the mains power supply.
- 4.1.2. Place the dust cup on the drill piece.
- 4.1.3. If the material to be drilled is not fixed in place, it should be secured in a vice or with clamps to keep it from turning as the drill bit rotates.
- 4.1.4. If the surface is smooth, create a guide groove at the point of hole location. This will prevent bit from slipping as you start to drill. Alternatively, drill a pilot hole to assist the final drill size through the work piece. Lock a pilot drill into the chuck (a smaller size drill than finished hole size, you may need to use standard chuck), and drill a pilot hole. Insert the final sized bit into appropriate chuck or locking collar. In addition to other safety items also wear an appropriate dust mask.
- 4.1.5. To increase drill penetration switch the hammer action on. Set the control switches according to 3.2.
- 4.1.6. Plug drill into mains power supply and hold drill firmly, placing the bit at the entrance of the pilot hole, or at the point to be drilled.
- 4.1.7. Depress the trigger to start drill. Move the drill bit into the work piece applying only enough pressure to keep the bit cutting. DO NOT force the drill or apply side pressure to elongate the hole. Allow the hammer action to progress the hole. Occasionally remove the drill to expel dust from the hole.
- 4.1.8. If the bit jams in the work piece or if the drill stalls, release the trigger immediately. Remove the bit from the work piece and determine the reason for jamming.
- 4.1.9. The depth gauge may be used to pre-determine the depth of hole.

4.2. CHISEL USE on MASONRY, BRICK, STONE, ROCK OR CONCRETE.

⚠ WARNING! DO NOT USE DRILL MODE, use hammer action only. DO NOT USE WITH CONVENTIONAL CHUCK.

- 4.2.1. Ensure drill is unplugged from the mains power supply.
- 4.2.2. Place the dust cup on the chisel bit.
- 4.2.3. Set the control switches according to 3.2.
- 4.2.4. Plug drill into mains power supply and hold drill firmly placing the chisel bit on the area of proposed impact.
- 4.2.5. Depress the trigger to start and progress the task accordingly.

4.3. DRILLING WOOD AND PLASTIC.

DO NOT use the hammer action when drilling wood or plastic materials.

- 4.3.1. Ensure drill is unplugged from the mains power supply.
- 4.3.2. If the material to be drilled is not fixed in place, it should be secured in a vice or with clamps to keep it from turning as the drill bit rotates.
- 4.3.3. A pilot hole may be necessary to assist the final drill size through the work piece. Lock a pilot drill into the chuck (a smaller size drill than finished hole size, you may need to use standard chuck), and drill a pilot hole. Insert the final sized bit into appropriate chuck or locking collar.
- 4.3.4. Plug drill into mains power. Hold drill firmly placing the bit at entrance of the pilot hole, or hole location mark and depress the trigger.
- 4.3.5. Move the drill bit into the work piece applying only enough pressure to keep the bit cutting. DO NOT force the drill or apply side pressure to elongate the hole.
- 4.3.6. Great care must be taken when drilling plastic to avoid cracking the work piece.
- 4.3.7. If the bit jams in the work piece or if the drill stalls, release the trigger immediately. Remove the bit from the work piece and determine the reason for jamming.
- 4.3.8. The depth gauge may be used to pre-determine the depth of hole.

4.4. DRILLING METAL.

DO NOT use the hammer action when drilling metal.

- 4.4.1. Ensure drill is unplugged from the mains power supply.
- 4.4.2. If the material to be drilled is not fixed in place, it should be secured in a vice or with clamps to keep it from turning as the drill bit rotates.
- 4.4.3. Use a centre punch to mark desired hole location. This will prevent bit from slipping as your start to drill. Alternatively, drill a pilot hole to assist the final drill size through the work piece. Lock a pilot drill into the chuck (a smaller size drill than finished hole size, you may need to use standard chuck), and drill a pilot hole. Insert the final sized bit into appropriate chuck or locking collar.
- 4.4.4. When drilling metals, use a light oil on the drill bit to keep it from overheating. Oil will prolong life of bit and improve the drilling action. If possible, place a wooden block under metal work piece at the point where the drill will break through.
- 4.4.5. Plug drill into mains power supply and hold drill firmly placing the bit at the entrance of the pilot hole.
- 4.4.6. Depress the trigger to start drill. Move the drill bit into the work piece applying only enough pressure to keep the bit cutting. DO NOT force the drill or apply side pressure to elongate the hole.
- 4.4.7. If the bit jams in the work piece or if the drill stalls, release the trigger immediately. Remove the bit from the work piece and determine the reason for jamming.
- 4.4.8. The depth gauge may be used to pre-determine the depth of hole.

4.5. WORK COMPLETE

⚠ WARNING! drill bits become very hot during use. Allow to cool or hold with a cloth for removal.

When you have finished working, unplug from the mains power supply, remove the bit from the chuck, clean drill, clean and if necessary sharpen the tool bits. Store drill in its carry case and place in a safe, dry, childproof area.

5. MAINTENANCE

WARNING! Ensure the drill is disconnected from the mains power supply before attempting any maintenance.

5.1. Cleaning

Keep drill ventilation slots clean and free from obstructions. At the end of work, thoroughly clean the air vents with a dry brush. If available blow compressed air into the vents to clear any internal dust (safety goggles must be worn when undertaking this process). Keep outer case of the drill clean and free from grease. DO NOT wash with water, solvents or use abrasives. Only wipe with a damp soft cloth.

5.2. Lubrication

Regularly check the hammer connecting rod and parts. To do so loosen cover (fig 8.Z), check grease sufficiently covers the connecting rod and other moving parts. If necessary, apply additional grease from the tub supplied with drill. If these components are not correctly greased the drill may seize causing permanent damage, and invalidating your warranty.

5.3. Changing carbon brushes

Periodically check the carbon brushes for wear. To access brushes remove the brush cover (fig8.10) with a screw driver. Remove, check and clean the brushes. If worn or damaged replace with new brushes. Contact your local Sealey dealer for details. Check that brushes can move freely and replace cover (10).

5.4. OTHER

Any other service or maintenance must be carried out by your local authorised service agent, or send back to us with proof of purchase if under warranty.

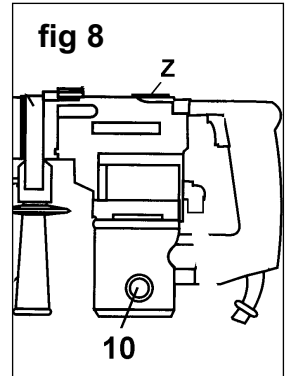

Declaration of Conformity We, the sole importer into the UK, declare that the product listed below is in conformity with the following EEC standards and directives.

Variable Speed Hammer Drill Model
SDS620

73/23/EEC Low Voltage Directive (S.I. 1994/3260)
89/336/EEC EMC Directive (S.I. 1992/2372 & Amendments)



The construction file for this product is held by the Manufacturer and may be inspected by a national authority upon request to Jack Sealey Ltd

Signed by Mark Sweetman

A handwritten signature in black ink, appearing to read 'Mark Sweetman'.

15th June 2000

For Jack Sealey Ltd. Sole importer into the UK of Sealey Power Tools.

NOTE: It is our policy to continually improve products and as such we reserve the right to alter data, specifications and component parts without prior notice.

IMPORTANT: No liability is accepted for incorrect use of this product. **WARRANTY:** Guarantee is 12 months from purchase date, proof of which will be required for any claim. **INFORMATION:** Call 01284 757525 for our catalogue & promotions. Leave your full name, address & postcode.

SEALEY POWER TOOLS

Sole UK Distributor,
Sealey Group, Bury St. Edmunds, Suffolk.



01284 757500



01284 703534

E-mail: sales@sealey.co.uk