

Thank you for purchasing a Sealey product. Manufactured to a high standard this product will, if used according to these instructions and properly maintained, give you years of trouble free performance.

**IMPORTANT: PLEASE READ THESE INSTRUCTIONS CAREFULLY. NOTE THE SAFE OPERATIONAL REQUIREMENTS, WARNINGS & CAUTIONS. USE THE PRODUCT CORRECTLY AND WITH CARE FOR THE PURPOSE FOR WHICH IT IS INTENDED. FAILURE TO DO SO MAY CAUSE DAMAGE AND/OR PERSONAL INJURY AND WILL INVALIDATE THE WARRANTY. PLEASE KEEP THESE INSTRUCTIONS SAFE FOR FUTURE USE.**

## 1. SAFETY INSTRUCTIONS

### 1.1. ELECTRICAL SAFETY

**WARNING!** It is the responsibility of the owner and the operator to read, understand and comply with the following: You must check all electrical products, before use, to ensure that they are safe. You must inspect power cables, plugs, sockets and any other connectors for wear or damage. You must ensure that the risk of electric shock is minimised by the installation of appropriate safety devices. A Residual Current Circuit Breaker (RCCB) should be incorporated in the main distribution board. We also recommend that a Residual Current Device (RCD) is used. It is particularly important to use an RCD with portable products that are plugged into a supply which is not protected by an RCCB. If in any doubt consult a qualified electrician. You may obtain a Residual Current Device by contacting your Sealey dealer. You must also read and understand the following instructions concerning electrical safety.

1.1.1. The Electricity at Work Act 1989 requires that all portable electrical appliances, if used on business premises, are tested by a qualified electrician, using a Portable Appliance Tester (PAT), at least once a year.

1.1.2. The Health & Safety at Work Act 1974 makes owners of electrical appliances responsible for the safe condition of those appliances and the safety of the appliance operators. If in any doubt about electrical safety, contact a qualified electrician.

1.1.3. Ensure that the insulation on all cables and on the appliance is safe before connecting it to the power supply. See 1.1.1. and 1.1.2. and use a Portable Appliance Tester.

1.1.4. Ensure that cables are always protected against short circuit and overload.

1.1.5. Regularly inspect power supply cables and plugs for wear or damage and check all connections to ensure that none is loose.

1.1.6. Important: Ensure that the voltage marked on the appliance matches the power supply to be used and that the plug is fitted with the correct fuse - see fuse rating at right.

1.1.7. **DO NOT** pull or carry the appliance by the power cable.

1.1.8. **DO NOT** pull the plug from the socket by the cable.

1.1.9. **DO NOT** use worn or damaged cables, plugs or connectors. Immediately have any faulty item repaired or replaced by a qualified electrician. When a BS 1363/A UK 3 pin plug is damaged, cut the cable just above the plug and dispose of the plug safely.

Fit a new plug according to the following instructions (UK only).

a) Connect the GREEN/YELLOW earth wire to the earth terminal 'E'.

b) Connect the BROWN live wire to the live terminal 'L'.

c) Connect the BLUE neutral wire to the neutral terminal 'N'.

d) After wiring, check that there are no bare wires, that all wires have been correctly connected, that the cable outer insulation extends beyond the cable restraint and that the restraint is tight.

Double insulated products, which are always marked with this symbol , are fitted with live (brown) and neutral (blue) wires only. To rewire, connect the wires as indicated above - DO NOT connect either wire to the earth terminal.

1.1.10. Products which require more than 13 amps are supplied without a plug. In this case you must contact a qualified electrician to ensure that a suitably rated supply is available. We recommend that you discuss the installation of an industrial round pin plug and socket with your electrician.

1.1.11. If an extension reel is used it should be fully unwound before connection. A reel with an RCD fitted is preferred since any appliance plugged into it will be protected. The cable core section is important and should be at least 1.5mm<sup>2</sup>, but to be absolutely sure that the capacity of the reel is suitable for this product and for others which may be used in the other output sockets, we recommend the use of 2.5mm<sup>2</sup> section cable.

### 1.2. GENERAL SAFETY

- ✓ Check that the dehumidifier is in sound condition and good working order. *Take immediate action to repair or replace damaged parts.*
- ✓ Use recommended parts only. *Unauthorised parts may be dangerous and will invalidate the warranty.*
- x **DO NOT** stand or place **any** object less than 10 cm from the front of the unit, 20cm from the rear and sides of the unit, and 30cm above the unit.
- x **DO NOT** obstruct the air intakes or outlets of the dehumidifier, and do not cover with washed clothes.
- x **DO NOT** place any object into the outlets - the unit has a fan running at high speed, contact with this will cause injury.
- x **DO NOT** operate the dehumidifier when you are tired or under the influence of alcohol, drugs or intoxicating medication.
- x **DO NOT** switch the dehumidifier off by disconnecting it from the mains. **ALWAYS** switch to the "OFF" position first.
- x **DO NOT** remove the float lever from the water collection tank.
- x **DO NOT** connect or disconnect the plug from the mains with wet hands.
- ✓ Always discard the water from the collection tank, **DO NOT** use it for any other purpose.
- ✓ Place the dehumidifier on a level and stable surface.
- ✓ To prevent water from freezing, do not use the dehumidifier at ambient temperatures below 0°C.
- ✓ Do not use the dehumidifier outside.
- ✓ When using continuous draining, make sure that the drain hose is positioned correctly.
- ✓ Ensure that heating appliances are not exposed to the flow of air from the dehumidifier.
- ✓ Before attempting to move the dehumidifier, empty the contents of the collection tank. Use top carrying handle when moving unit.
- ✓ Switch off and disconnect it from the mains before attempting any cleaning or other maintenance work.
- ✓ Ensure that the dehumidifier is correctly turned off when not in use, and stored in a safe, dry area, out of reach of children.

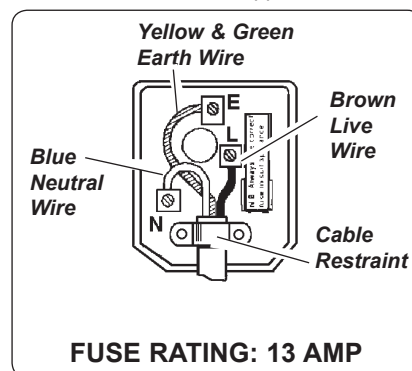

## 2. SPECIFICATION

Motor Power: ..... 230V 50Hz 400W  
 Dehumidifying Capacity:..... .20ltr/day  
 Working Space: ..... .20 to 30mtr<sup>2</sup>  
 Maximum Air Flow:..... 180mtr<sup>3</sup>/hr

Refrigerant:..... R134A  
 Condensate Tank: ..... 4.5ltr (with auto shut-off)  
 Working Temperature Range: ..... 5°C to 35°C  
 Weight: ..... 13kg

## 3. OPERATION

This dehumidifier is designed to remove uncomfortable humidity in daily life and to be used for auxiliary drying of washed clothes indoors. It is not suitable for keeping the humidity very low.

Efficiency of the dehumidifier is influenced by the air outside the room. For operating efficiently, try to avoid opening and closing the windows and doors.

For best performance, operate the dehumidifier within the usable operating temperature. For safety purposes, the dehumidifying operation will stop automatically - and change to the air cleaning operation - when the ambient temperature is higher than approximately 35°C.

When the unit is switched on, the appropriate Humidity Indicator will light up and show the room humidity (high, medium or low).

See Figs 1, 2 and 3 for unit layout, controls and mode applications.

### 3.1. Automatic Mode

- 3.1.1. Set the air outlet in either the upward or downward position as required.
- 3.1.2. Press On/Off button to turn unit on, Automatic light will be lit and dehumidifying will commence.
- 3.1.3. The dehumidifying operation will stop automatically when humidity is below approximately 60%.
- 3.1.4. If required set the timer by pressing the Timer button - the order is 2 hours, 4 hours, 8 hours, Off, 2 hours.....etc.

### 3.2. Continuous Mode

- 3.2.1. Set the air outlet in either the upward or downward position as required.
- 3.2.2. Press On/Off button to turn unit on.
- 3.2.3. Press Mode button to select Continuous.
- 3.2.4. If required set the timer by pressing the Timer button - the order is 2 hours, 4 hours, 8 hours, Off, 2 hours.....etc
- 3.2.5. If placing unit in a closet or similar, ensure front of unit is towards the door and also ensure that the minimum distances of 10cm to the front, 20cm to the sides and rear, and 30cm over the top are adhered to. Also ensure that when closing the door, the power cord is not trapped.

### 3.3. Dry Clothes Mode

- 3.3.1. Set the air outlet in either the upward or downward position as required.
- 3.3.2. Press On/Off button to turn unit on.
- 3.3.3. Press Mode button to select Dry Clothes.
- 3.3.4. If required set the timer by pressing the Timer button - the order is 2 hours, 4 hours, 8 hours, Off, 2 hours.....etc.

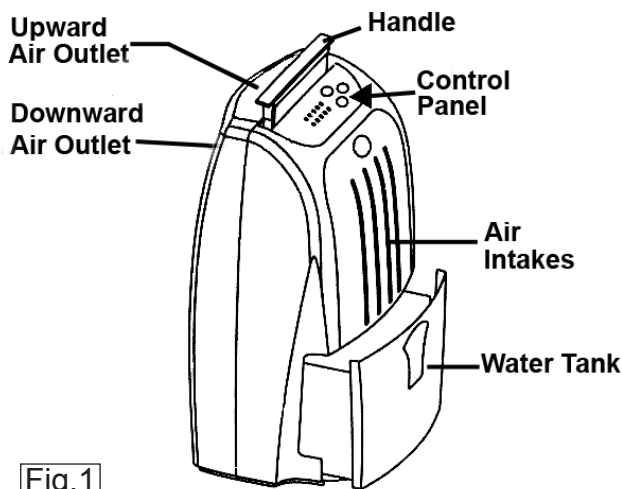

Fig. 1

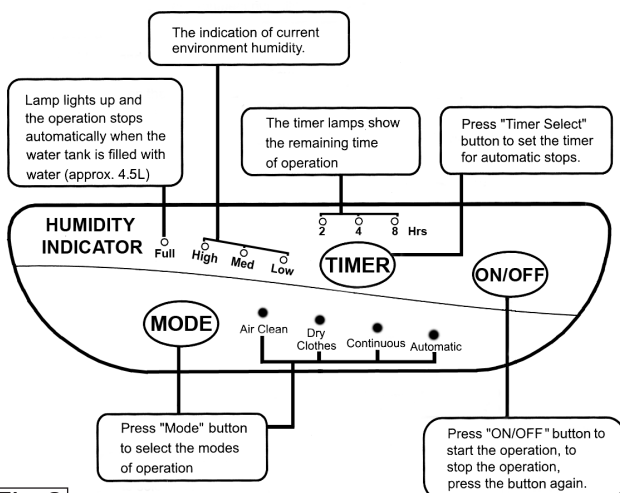

Fig. 2

Fig. 3

		MODE
To dehumidify a room for comfort or to keep ceiling or walls clear of condensation		AUTOMATIC
To dehumidify a wardrobe or cupboard		CONTINUOUS
To dry washed clothing faster		DRY CLOTHES
To dry a carpet or a rug		DRY CLOTHES
To dehumidify a small space or to dry shoes		DRY CLOTHES
To make air clean in a room		AIR CLEAN

### 3.4. Air Clean Mode

This unit is not intended for use exclusively as an air cleaner. Air cleaning function will not work if the air cleaning filter is dirty, clogged or in need of replacement.

3.4.1. Set the air outlet in either the upward or downward position as required.

3.4.2. Press On/Off button to turn unit on.

3.4.3. Press Mode button to select Air Clean.

3.3.4. If required set the timer by pressing the Timer button - the order is 2 hours, 4 hours, 8 hours, Off, 2 hours.....etc.

**Notes:** If for any reason the unit should overheat, the overheat protection device will stop the unit operating. This will stop the dehumidifying operation for approximately 3 minutes. After recovery, the Automatic mode light will flash. Press On/Off button to start the operation again. Circulation of the refrigerant may cause some noise within the dehumidifier when operation is started. The dehumidifier will stop automatically after the hours set by the timer, to change the time set - Press Timer button - the order is 2 hours, 4 hours, 8 hours, Off, 2 hours.....etc. This can be set in any mode.

### 3.5. Defrosting Operation

The evaporator within the dehumidifier frosts during the dehumidifying operation at a room temperature of approximately 15°C or less. To remove frost, the defrosting device works automatically at an interval of approximately every 30 minutes for a duration of approximately 5 minutes. Both the dehumidifying function and the air cleaning function stop during the defrosting operation. Do not disconnect the plug or turn off the unit during the defrosting operation.

Note: This dehumidifier does not have a cooling function, it produces heat during the operation and room temperature will rise by 1°C to 4°C. The temperature gets higher while it is operated in a closet, or similar. Furthermore, room temperature will rise because doors and windows are closed and heat is produced from other appliances in the room and from sun radiation.

### 3.6. Emptying the water collection tank

During the dehumidifying operation, water is collected in the water collection tank. When the tank is full of water, the dehumidifier stops operating automatically and the warning buzzer sounds. The unit will not restart until the water collection tank has been emptied.

3.6.1. Remove water collection tank from the dehumidifier by pulling it gently outwards by holding the sides of the tank.

3.6.2. Hold the tank by the handle and carry it carefully to an emptying point.

3.6.3. Tilt the tank in the direction as shown (Fig.4) and slowly empty the water out of the tank.

3.6.4. Refit the tank in the dehumidifier, making sure it is properly back in place as the unit will not restart if it is not fitted properly.

**Note:** The buzzer will sound for 10 seconds when the tank is taken out during this operation.

### 3.7. Continuous draining

3.7.1. If there is a place suitable for draining, continuous draining can be carried out. The continuous operation enables the dehumidifying operation to continue uninterrupted.

3.7.2. Turn off the dehumidifier, disconnect the power plug and remove the water collection tank.

3.7.3. A hose for will be required for draining - the length required is the distance to the place for draining plus approx.30cm, It should have an inner diameter of 15mm and outer diameter of approx. 20mm. If preferred, a suitable right-angled connector can be used with an approx. inner diameter of 15mm. The hose required will then depend on the size of the connector outlet.

3.7.4. To make the openings in the rear of the dehumidifier (one in rear cover and one at rear of water collection tank department), remove the covers carefully by means of a screwdriver or knife.

3.7.5. Securely place the right-angled connector (or hose) over the drain pipe outlet and then fit the hose onto the connector (if required). The hose should be fed through and out of the rear cover. Refit the water collection tank (the unit will not be operate without the tank in place).

3.7.6. Continue to use the dehumidifier as normal.

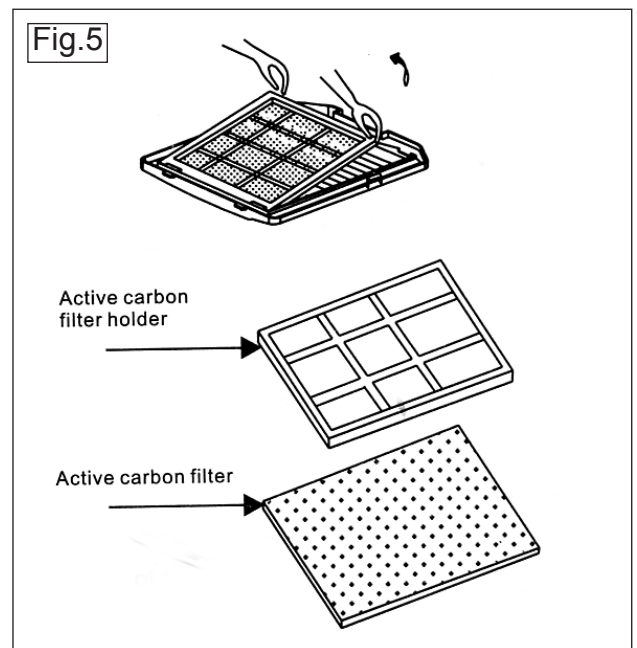
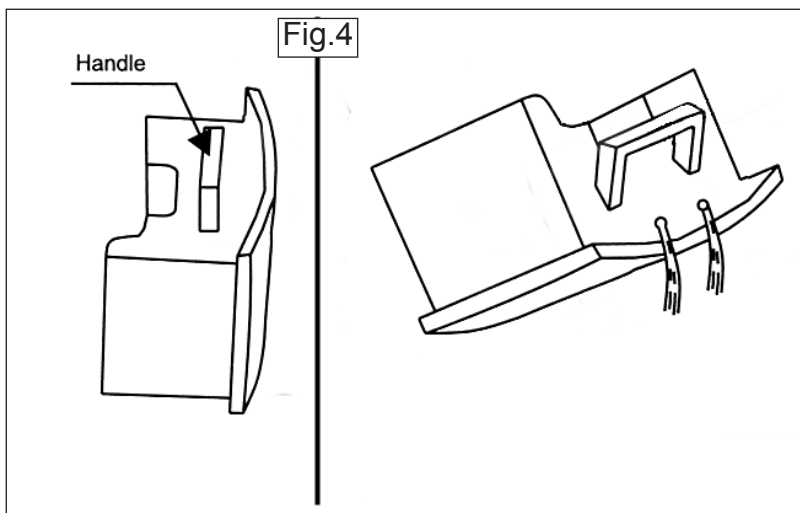

### 3.8. Cleaning Air Filter (every 2 weeks)

The dehumidifying capacity is lowered when the air cleaning filter becomes clogged.

3.8.1. Remove the water collection tank and then remove the front cover from the unit.

3.8.2. Remove the filter holder, open the filter holder and take out the air cleaning filter (Fig.5).

3.8.3. To dislodge the dust from the filter, use a vacuum cleaner or tap it lightly.

3.8.4. If the filter is very dirty, wash it carefully in water with a neutral detergent, then rinse well with clean water and leave until dry.

3.8.5. Refit the air filter to the filter holder and clip into place.

3.8.6. Refit the filter holder into the unit, then replace the front cover and the water collection tank.

**3.9. Replacing the Air Filter (every 6 months)**

The life span of the air cleaning filter is approximately 6 months depending on the air conditions where the dehumidifier has been used. When replacing the filter, a genuine Sealey filter should always be fitted - Part No: SDH20.03 (see parts list). Do not deform the filter or damage it.

**3.10. Storage**

- 3.10.1. Unplug the unit, bundle the power cord, and hang the bundled cord at the back of the unit.
- 3.10.2. Remove the water collection tank and empty the water out of it. Remove the tank cover and wash the inside of the tank with clean water. The tank may be scratched if it is scrubbed strongly with a brush. Do not remove the float lever from the tank. Wipe off the water on the outside of the tank with a cloth. Refit the tank cover onto the tank and replace the tank in position.
- 3.10.3. Clean the air cleaning filter (see above).
- 3.10.4. When the unit is to be stored for a long time, wipe the dehumidifier over with a dry soft cloth. To remove dirt, wipe over with a very slightly dampened cloth (never use a wet cloth for cleaning the controls). To avoid deformation or cracking, do not use benzine, thinner or liquid cleaners.
- 3.10.5. When storing, place in a safe, dry, childproof location. Stand the unit upright and avoid exposure to direct sunlight.

**Before attempting any repair, check for the following:**

**Dehumidifier does not operate**

- Check to see if the plug is disconnected. - Insert the plug into an electrical outlet fully and securely - check fuse in plug is OK.
- Check to see if the water tank is full of water. - Empty water out of the tank.
- Check to see if the water tank is fitted properly in position. - Fit the tank to the unit in the correct position.

**Dehumidified volume is small**

- Check to see if the filter is dirty. - Clean the filter as specified.
- Check to see if the air opening is blocked. - Remove any obstacles from the air opening.
- Check to see if the dehumidifier is in air clean mode. - Change the operation mode to the dehumidifying mode.
- Dehumidifier volume decreases when temperature is low. - The unit stops dehumidifying when the room temperature is below approx 5°C.
- Humidity in room has reached a low level. - Dehumidifying stops because the humidity level is below 60% in "Automatic" mode.



**Operation stops during spot dehumidifying**

- Room temperature is above the operating temperature. - The dehumidifying operation will start automatically when the temperature drops to 35°C.

**The humidity remains too high**

- The room size may be too large. - Ideally unit should only be used in rooms with up to 30mtr<sup>2</sup> floor space.
- The doors and windows may be opened and closed frequently. - Keep windows and doors shut during operation
- The dehumidifier is used together with a kerosene heater which emits water vapour. - Turn the heater off.

**Environmental Protection.**

Recycle unwanted materials instead of disposing of them as waste. All tools, accessories and packaging should be sorted, taken to a recycle centre and disposed of in a manner which is compatible with the environment.

When the product is no longer required, it must be disposed of in an environmentally protective way. Contact your local solid waste authority for recycling information.

**WARNING:** Do not dispose of by fire. This could result in an explosion.

**4 . DECLARATION OF CONFORMITY**

**Declaration of Conformity** We, the sole importer into the UK, declare that the product listed below is in conformity with the following standards and directives

**20 Litre Dehumidifier -**  
**Model: SDH20.V2**  
 73/23/EEC Low Voltage Directive  
 89/336/EEC EMC Directive  
 2002/95/EC RoHS Directive  
 2002/96/EEC WEEE Directive  
 93/68/EEC CE Marking Directive

Signed by Steve Buckle  26 November 2008

**CE** For Jack Sealey Ltd. Sole importer into the UK of Sealey Power Products.

The construction file for this product is held by the Manufacturer and may be inspected on request by contacting Jack Sealey Ltd.

**NOTE:** It is our policy to continually improve products and as such we reserve the right to alter data, specifications and component parts without prior notice.  
**IMPORTANT:** No liability is accepted for incorrect use of this product.  
**WARRANTY:** Guarantee is 12 months from purchase date, proof of which will be required for any claim.  
**INFORMATION:** For a copy of our catalogue and latest promotions call us on 01284 757525 and leave your full name, address and postcode.

<b>SEALEY POWER PRODUCTS</b>	Sole UK Distributor Sealey Group, Bury St. Edmunds, Suffolk.	 01284 757500  01284 703534	 <a href="http://www.sealey.co.uk">www.sealey.co.uk</a>  <a href="mailto:sales@sealey.co.uk">sales@sealey.co.uk</a>
------------------------------	--	--	--