



7,000,9000 BTU/HR PORTABLE AIR CONDITIONER/ DEHUMIDIFIER/AIR COOLER, WINDOW SEALING KIT

MODEL NO: **SAC7000, SAC9002.V3, SACWK1**

Thank you for purchasing a Sealey product. Manufactured to a high standard, this product will, if used according to these instructions, and properly maintained, give you years of trouble free performance.

IMPORTANT: PLEASE READ THESE INSTRUCTIONS CAREFULLY. NOTE THE SAFE OPERATIONAL REQUIREMENTS, WARNINGS & CAUTIONS. USE THE PRODUCT CORRECTLY AND WITH CARE FOR THE PURPOSE FOR WHICH IT IS INTENDED. FAILURE TO DO SO MAY CAUSE DAMAGE AND/OR PERSONAL INJURY AND WILL INVALIDATE THE WARRANTY. KEEP THESE INSTRUCTIONS SAFE FOR FUTURE USE.



Refer to instructions



Do not cover



Indoor use only



Caution: risk of fire

1. SAFETY

1.1. ELECTRICAL SAFETY

- WARNING!** It is the responsibility of the owner and the operator to read, understand and comply with the following:
You must check all electrical products, before use, to ensure that they are safe. You must inspect power cables, plugs, sockets and any other connectors for wear or damage. You must ensure that the risk of electric shock is minimised by the installation of appropriate safety devices. A Residual Current Circuit Breaker (RCCB) should be incorporated in the main distribution board. You must also read and understand the following instructions concerning electrical safety.
- ✓ Ensure that cables are always protected against short circuit and overload.
- ✓ Regularly inspect power supply cables and plugs for wear or damage and check all connections to ensure that none are loose.
- ✓ Ensure that the voltage marked on the appliance matches the power supply to be used and that the plug is fitted with the correct fuse - see fuse rating at right.
- ✗ **DO NOT** use worn or damaged cables, plugs or connectors. Have any faulty item repaired or replaced immediately by a competent electrician.
- ✓ It is recommended that this device is wired directly to a fused isolator switch. If, however, a plug is fitted, the following applies:
- ✓ Fit a new plug according to the following instructions (UK only).
 - a) Connect the GREEN/YELLOW earth wire to the earth terminal 'E'.
 - b) Connect the BROWN live wire to the live terminal 'L'.
 - c) Connect the BLUE neutral wire to the neutral terminal 'N'.
 - d) After wiring, check that there are no bare wires, that all wires are correctly connected, that the cable restraint is tight.

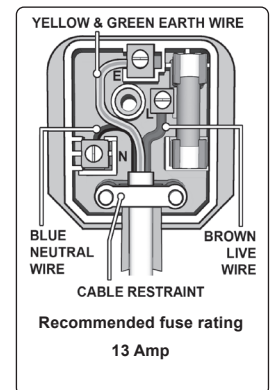

1.2. GENERAL SAFETY

- ✓ Check that the unit is in sound condition and good working order. Take immediate action to repair or replace damaged parts. Use recommended parts only. Unauthorised parts may be dangerous and will invalidate the warranty.
NOTE: The appliance is designed for use with propane gas R290 only as it's designated refrigerant.
- WARNING:** The refrigerant loop is sealed. Servicing should only be carried out by a qualified technician.
- ✗ **DO NOT** discharge the refrigerant into the atmosphere.
NOTE: Only install or operate in a room with a floor area exceeding 7m².
- ✗ **DO NOT** attempt any repairs or maintenance unless suitably qualified.
- ✗ **DO NOT** stand or place any object closer than 500mm (20 inches) from the unit.
- ✗ **DO NOT** obstruct the air intakes or outlets of the unit.
- ✗ **DO NOT** cover with items of clothing. **DO NOT** sit or climb onto the unit.
- ✗ **DO NOT** place any object into the outlets.
- ✗ **DO NOT** operate the unit when you are tired or under the influence of alcohol, drugs or intoxicating medication.
- ✗ **DO NOT** switch the unit off by disconnecting it from the mains. **ALWAYS** switch it off using the Power button.
- ✗ **DO NOT** remove the float lever from the water collection tank.
- ✗ **DO NOT** connect or disconnect the plug from the mains or use the unit with wet hands. Keep the unit dry.
- ✗ **DO NOT** use the unit outside.
- ✗ **DO NOT** install or operate this air conditioner in a bathroom or other wet environments.
- ✓ To prevent water from freezing, **DO NOT** use the unit at ambient temperatures below 0°C.
- ✓ Always discard the water from the collection tank, **DO NOT** use it for any other purpose.
- ✓ Place the unit on a level and stable surface.
- ✓ If the appliance is tipped at an angle greater than 45°, leave it to stand for at least 24 hours before use.
- ✓ Ensure that heating appliances are not exposed to the flow of air from the unit.
- ✓ Before attempting to move the unit, empty the contents of the water tank. Use carrying handle (fig1.3) when moving unit.
- ✓ Switch off and disconnect unit from the mains before attempting any cleaning or other maintenance work.
- ✓ Ensure that the unit is turned off correctly when not in use, and stored in a safe, dry area, out of reach of children.
NOTE: This appliance can be used by children aged from 8 years and above and persons with reduced physical, sensory or mental capabilities or lack of experience and knowledge if they have been given supervision or instruction concerning use of the appliance in a safe way and understand the hazards involved. Children shall not play with the appliance. Cleaning and user maintenance shall not be made by children without supervision.

2. INTRODUCTION

3-in-1 High capacity, compact, portable air conditioner, air cooling with ventilation and dehumidifying functions. Thermostatically controlled with built-in 24hr timer and sleep mode. Soft-touch control panel with LED digital display and remote control. Self-evaporating system reuses the moisture it collects from the air to help with the cooling process allows better efficiency, low maintenance and powerful cooling. Water-full indicator with auto-shut-off. Supplied with extendable exhaust ducting with window kit for ventilation and continuous drain hose. Dehumidifying function capable of removing up to 14.6L/day. Eco-Friendly R290 refrigerant. Air conditioning temperature range 16-32°C. Washable filter. Auto-defrost function at low ambient temperature. Mounted on castor wheels for manoeuvrability.

3. SPECIFICATION

Model No.: SAC7000
 Cooling Capacity:.....7000Btu/hr
 Discharge Side Pressure:3.2MPa
 Energy Rating: A (EER:2.6)
 IP Rating: IPX1
 Mass of Refrigerant:..... 120g
 Maximum Airflow:.....290m³/hr
 Maximum Exhaust Hose Length: 1.5m
 Maximum Water Extraction Rate:..... 14.6L/day
 Noise Level: 65db(A)
 Power:.....780W
 Rated Capacity:2050W
 Refrigerant: R290
 Suction Side Pressure:.....0.7MPa
 Supply:.....230V~50Hz

Model No.: SAC9000.V3
 Cooling Capacity:.....9000Btu/hr
 Discharge Side Pressure:3.2MPa
 Energy Rating: A (EER:2.6)
 IP Rating: IPX1
 Mass of Refrigerant:..... 170g
 Maximum Airflow:.....330m³/hr
 Maximum Exhaust Hose Length: 1.5m
 Maximum Water Extraction Rate:..... 25L/day
 Noise Level: 65db(A)
 Power:.....1005W
 Rated Capacity:2600W
 Refrigerant: R290
 Suction Side Pressure:.....0.7MPa
 Supply:.....230V~50Hz

4. CONTENTS

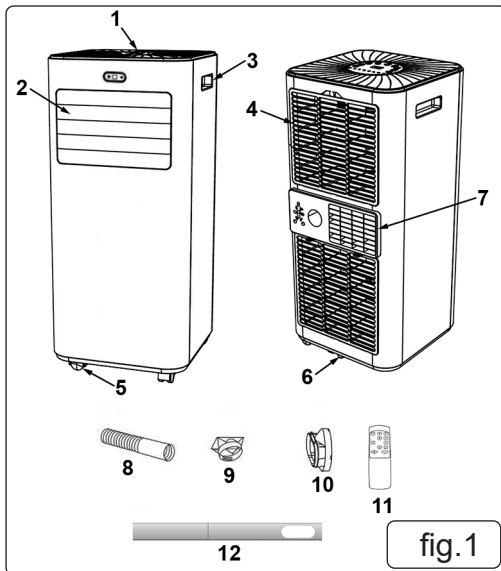

ITEM	DESCRIPTION
1	Control panel
2	Air outlet with adjustable louvre
3	Handle
4	Air inlet and filter
5	Castor wheel
6	Drainage hole
7	Air exhaust
ACCESSORIES	
8	Exhaust hose
9	Hose connector
10	Window kit adaptor
11	Remote control
12	Window kit
13	Drain hose (not shown)

5. INSTALLATION

Unpack the product and check contents. Should there be any damaged or missing parts contact your supplier immediately.

5.1. LOCATION

5.1.1. Place the appliance on a firm, level surface.

5.1.2. Ensure that there is a clear area of at least 500mm around the appliance (fig.2) to allow for adequate air circulation.

× **DO NOT** operate the appliance in close proximity to walls, curtains or other objects that may block the air inlet or outlet.

□ **WARNING! DO NOT** locate the appliance where it is subject to:

Heat sources such as radiators, ovens or similar

Direct sunlight

Mechanical vibration or shock

Excessive dust

Lack of ventilation i.e., inside a cabinet or bookcase

Uneven surfaces

5.2. ASSEMBLE THE EXHAUST HOSE

□ **WARNING!** The air conditioning unit must be vented to outside. This ensures that any heat and moisture is removed from the designated room space.

5.2.1. Screw fit the hose connector to one end of the exhaust hose (fig.3).

5.2.2. Screw fit the window kit adaptor to the other end of the exhaust hose (fig.4).

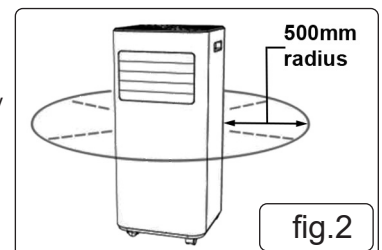

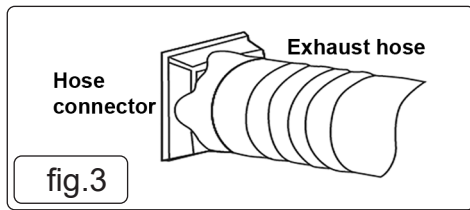

fig.3

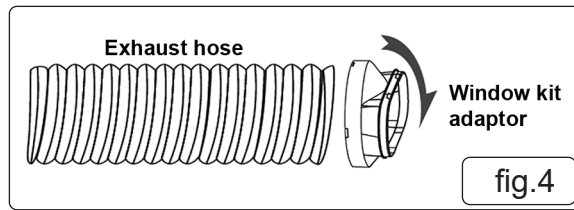

fig.4

5.3. WINDOW KIT ASSEMBLY

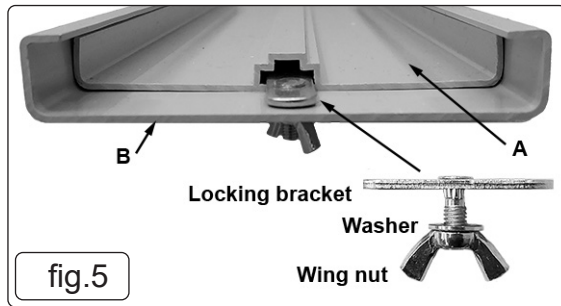

fig.5

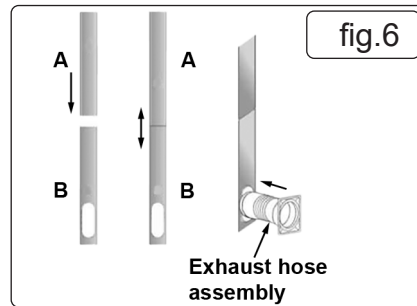

fig.6

- 5.3.1. Locate window kit locking bracket's threaded shaft through hole in window kit part B (fig.5).
 - 5.3.2. Attach washer and wing nut to threaded shaft (fig.5).
 - 5.3.3. Slide window kit part A into part B (fig 6) and locate locking bracket plate into central slot on part A (fig.5).
 - 5.3.4. Extend the adjustable window kit to suit the size of the window and tighten the wing nut (fig.5) to lock.
 - 5.3.5. Attach exhaust hose assembly, see section 5.2, to window kit part B (fig.6).
- 5.4. ATTACH WINDOW KIT ASSEMBLY SEE ALSO SECTION 10 FOR ALTERNATIVE WINDOW KIT INCLUDED WITH THE MODEL'S

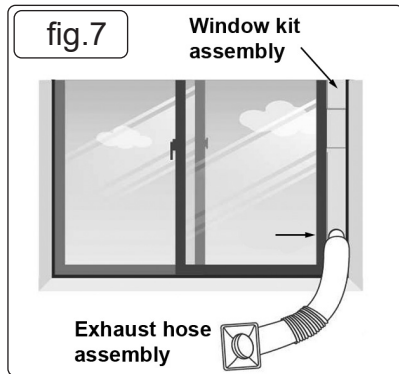

fig.7

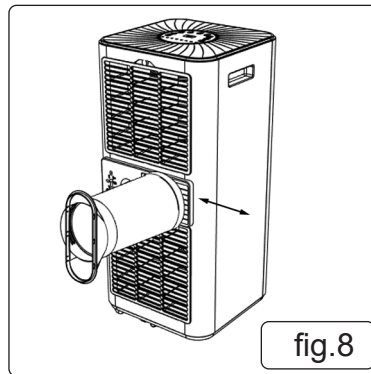

fig.8

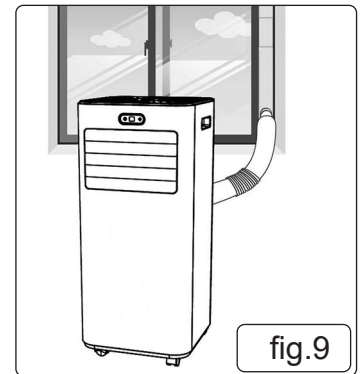

fig.9

- 5.4.1. Open the window and place the window kit into position, then close the window onto the window kit (fig.7).
NOTE: To obtain maximum efficiency it is recommended that any gaps between the window kit and the sides of the window are sealed.
- 5.4.2. Attach the hose connector on the hose assembly to the exhaust outlet (fig.1 #7) by sliding the it horizontally into position (fig.8).
- 5.4.3. Place the appliance near to a suitable electrical power outlet and adjust the flexible exhaust hose to suit, avoiding any sharp bends to the hose (fig.9).
- 5.4.4. Adjust the louvre panel (fig.1 #2) to suit (fig.9).

6. OPERATION

6.1. CONTROL PANEL AND DISPLAY

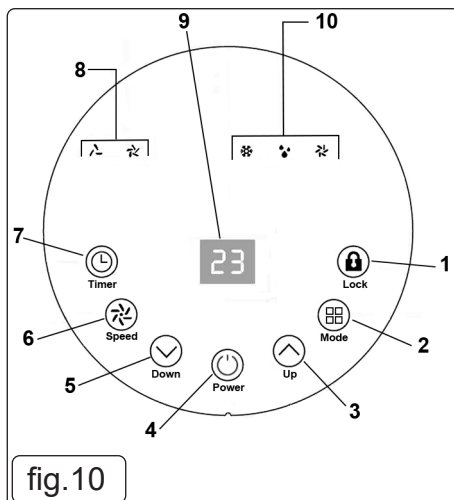
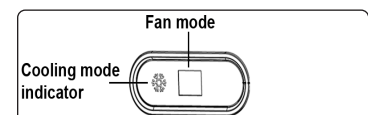

fig.10

1	LOCK	Press to turn ON or OFF the child lock function
2	MODE	Press to switch operation mode between cooling, dehumidifier and fan
3	UP	Increase temperature (16°C~32°C) or timer setting
4	POWER	Press to turn the unit ON or OFF
5	DOWN	Decreasing the temperature or timer setting
6	SPEED	Press to switch the fan speed between HIGH or LOW
7	TIMER	Sets a time for the unit to automatically START or STOP
8	FAN SPEED INDICATOR	Displays HIGH or LOW fan speed
9	DIGITAL DISPLAY	Displays timer setting and room temperature
10	MODE INDICATOR	Mode display between Cooling, Dehumidifying and Fan

- 6.1.1. The display on the front face of the unit will only light when the unit is in cooling mode.



6.2. SETTINGS

6.2.1. START UP AND SHUTDOWN

- 6.2.1.1. Press POWER to turn the unit ON (fig.10 #4).
- 6.2.1.2. Press MODE button to select the desired operation mode (fig.10 #2).
- 6.2.1.3. Press POWER again to turn the unit OFF (fig.10 #4).

6.2.2. OPERATION MODE

The unit has four operation modes: Cool, dehumidifier, fan and sleep.

6.2.3. COOLING A ROOM

- 6.2.3.1. Select the COOL mode to lower the temperature in a room.
- 6.2.3.2. Press MODE button (fig.10 #2) until the COOL indicator illuminates (fig.10 #10).
- 6.2.3.3. Press the UP or DOWN button (fig.10 #3 #5) to adjust the temperature to the desired level. The temperature will be displayed on the screen (fig.10 #9). The temperature can be set between 16°C to 32°C.
- 6.2.3.4. Press the Speed button (fig.10 #6) Until the desired fan speed indicator illuminates (fig.10 #8).

NOTE: The horizontal air flow direction is controlled by adjusting the air outlet louvres (fig.1 #2).

- **WARNING!** The air conditioner function will stop if the room temperature is lower than the selected temperature.

6.2.4. VENTILATE THE ROOM

- 6.2.4.1. Press the MODE button (fig.10 #2) until the FAN indicator illuminates (fig.10 #10).
NOTE: In ventilation mode the room air is circulated NOT cooled.
- 6.2.4.2. Press the Speed button (fig.10 #6) Until the desired fan speed indicator illuminates (fig.10 #10).

6.2.5. DRYING THE ROOM

- 6.2.5.1. Press the MODE button on the control panel (fig.10 #2) until the DRY indicator illuminates (fig.10 #10), or press the DRY button on the remote control (fig.11).
- 6.2.5.2. Connect the drain hose (fig.1 #13) To the drain outlet at the bottom of the unit (fig.1 #6). See section 6.5.
NOTE: In this mode the fan speed is set to low level and cannot be changed.

6.2.6. SLEEP MODE

- **WARNING!** This function can only be activated by using the SLEEP button on the remote control (fig.11). To activate the sleep mode the unit must be in the COOL mode.
- 6.2.6.1. To activate COOL mode press the COOL button on the remote control and then press the SLEEP (fig.11).
NOTE: After 1 hour the pre-set temperature is increased by 1°C and increased again by 1°C the following hour.

6.2.7. TIMER SETTING (1 to 24 hours)

- 6.2.7.1. The TIMER has two ways of operation and can be activated by either the button on the control panel (fig.10 #7) or by the TIMER button on the remote control (fig.11).

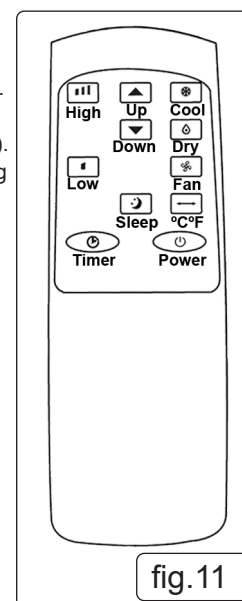
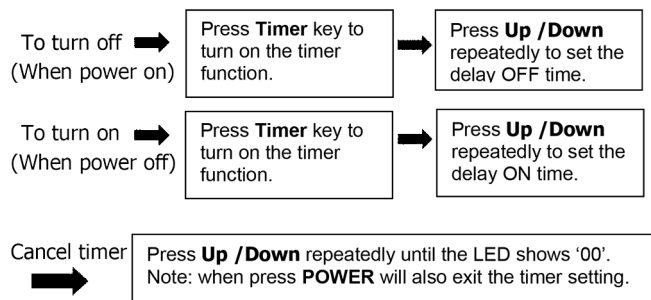

6.3. AUTOMATIC DEFROST

During use if operating at low room temperatures frost may build up at the evaporator. The POWER indicator will start to blink and the unit will automatically begin to defrost.

The defrost control sequence is as follows:

- A.** If operating the unit in either the cooling or drying mode, the ambient temperature sensor senses that the evaporator coil temperature is below -1°C the compressor will stop. It will restart again, in the COOL mode, after 10 minutes or when the coil reaches the temperature of 7°C.
- B.** If operating the unit in the drying mode, the coil temperature sensor senses that the temperature of the evaporator is below 40°C and the differential temperature between the coil temperature and the ambient room temperature is below 19°C and the compressor has been in operation for twenty minutes the unit will start defrosting for five minutes and the POWER indicator will begin to blink.

6.4. OVERLOAD PROTECTION

If there is a loss of power, to protect the compressor, there is a three minute delay until the compressor will restart.

6.5. MANUAL DRAINAGE

NOTE: When the unit is full of water it will automatically shut off.

- 6.5.1. Switch off the unit and remove the electrical plug from it's power source.
- 6.5.2. With care move the unit to suitable location to enable a container to be located below the bottom drainage hole (fig.1 #6).
- 6.5.3. With the container in place remove the drain plug (fig.12).
□ **WARNING!** The water will flow out instantly from the drainage hole.
- 6.5.4. When the unit has completely drained replace the drain plug back fully into the drainage hole.
NOTE: To assist with drainage the unit can be slightly tilted backwards to allow the drain plug to be re-inserted if the container becomes full.
- 6.5.5. Replace the electric plug into the power source and re-start the appliance in the desired mode.
□ **WARNING!** Ensure that the drain plug is fully inserted, otherwise the condensate water will flow out onto the floor.

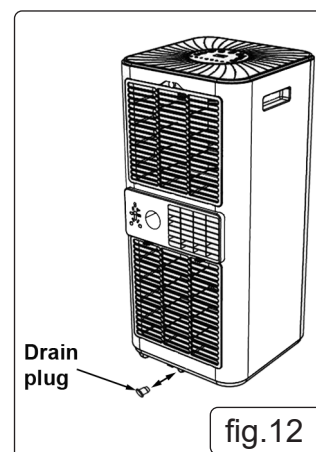

6.6. CONTINUOUS DRAINAGE

To provide a more efficient performance the self-evaporating system uses the collected water to cool the condenser coils.

It is recommended not to use the continuous drain method in the cooling mode.

The condensate water evaporates at the condenser and is expelled through the exhaust hose.

6.6.1. Switch off the unit and remove the electrical plug from its power source.

6.6.2. Release the cover from the water outlet opening (fig.13).

6.6.3. With care push fit one end of the drain hose onto the water outlet (fig.13).

6.6.4. Securely place the other end of the drain hose over a suitably sized container or drain.

☐ **WARNING!** Ensure that the drain hose is straight and free from any kinks and at an inclination angle downwards of not more than 20°.

✗ **DO NOT** allow the open end of the drain hose to be submerged into the water. This may cause an air lock in the hose.

NOTE: The condensate water will automatically flow into the container or drain.

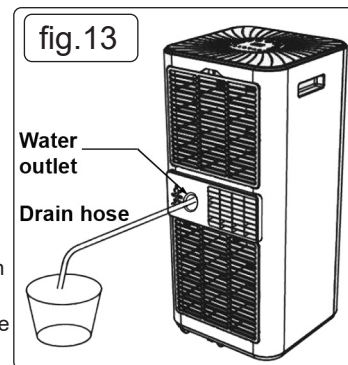

7. MAINTENANCE

NOTE: Maintenance, service and repair must be carried out by qualified person. Contact your Sealey stockist for details.

7.1. CLEANING

7.1.1. Switch off the unit and remove the electrical plug from its power source.

7.1.2. Clean the unit with soft damp cloth.

✗ **DO NOT** use solvents.

7.2. CLEANING THE AIR FILTER

The air filter requires regular cleaning. A restricted airflow will reduce the efficiency of the system.

It is recommended that air filter is cleaned every two weeks.

✗ **DO NOT** operate the unit without an air filter.

7.2.1. Switch off the unit and remove the electrical plug from its power source.

7.2.2. Remove the filter mesh from the unit (fig.1 #4).

7.2.3. Use a household vacuum to remove any dust from the filter.

7.2.4. Turn the filter over and rinse the filter under running water (fig.14).

7.2.5. Allow the filter to dry before reinstalling.

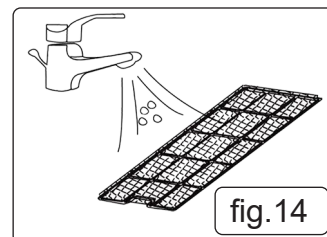

8. STORAGE

8.1. Turn on the unit and select the low wind ventilation mode. See section 6.2.4.

8.1.1. Leave in this condition until the drainage pipe becomes dry.

NOTE: This will help prevent mildew.

8.2. Switch off the unit and remove the electrical plug from its power source.

8.3. Remove the window kit, exhaust hose and drain hose.

8.4. Drain the remaining water from the unit. See section 6.5.

8.5. Replace any drainage plugs.

8.6. Clean the filter. See section 7.2.

8.7. Remove the batteries from the remote control.

8.8. Store the unit and accessories in its original packaging, in safe dry childproof location.

9. TROUBLESHOOTING

SYMPTOM		POSSIBLE CAUSE	REMEDY
The unit is not working		No power	Connect to power source and turn the unit ON
		Full water indicator is illuminated	Drain the water
		Low room temperature	Change the set temperature
The unit works with reduced capacity		Dirty air filter	Clean the air filter as required
		Air ducts are blocked	Clear obstacles. Re-position unit into clear space
		Doors or windows open	Close the doors and windows
		Incorrect mode and temperature selected	Select correct mode and temperature to suit desired application
		Detached exhaust hose	Securely reattach exhaust hose
Water leakage		Spillage when moving the unit	Empty the water tank before moving the unit
		The drain hose is kinked or bent	Straighten the drain hose
Excessive noise		The unit is on an uneven surface	Place the unit onto a flat horizontal surface
		Loose, vibrating parts	Check for loose parts and re-tighten
		Water flowing sound	Normal sound of refrigerant flowing
Error codes	E0	Communication faults between main PCB and display PCB	Contact Sealey service centre
	E1	Ambient temperature sensor fail	Contact Sealey service centre
	E2	Coil temperate sensor failures	Contact Sealey service centre
	Ft	Condensate water high level alarm	Drain the water

WINDOW SEALING KIT FOR AIR CONDITIONER DUCTING

MODEL NO: SACWK1

10. SAFETY

- × **DO NOT** cover the unit with this material, and do not obstruct the air inlet and outlet grilles of the machine with items such as clothing, soft furnishings, furniture, bedding etc.
 - × **DO NOT** use the material for any purpose other than that for which it is designed.
 - × **DO NOT** use in bathroom or shower room.
 - × **DO NOT** allow children to use, when not in use, store in a safe, cool, dry, childproof area.
- NOTE:** This material is not intended for use by persons (including children) with reduced physical, sensory or mental capabilities or lack of experience and knowledge, unless they have been given supervision or instruction concerning the use of the appliance by a person responsible for their safety. Children should be supervised to ensure that they do not play with this material.

11. INTRODUCTION

Suitable for all types of hinged windows including skylights up to 300cm total perimeter. Easy to install using the supplied roll of self-adhesive hook & loop tape. Double zip makes positioning the ducting at any height easy. Saves energy by making the air conditioner or dryer more effective.

12. CONTENTS

Window seal
Velcro tape



13. INSTRUCTIONS

- 13.1. CLEANING**
Clean the window and window frame, making them free from grease and dust.
- 13.2. CUTTING THE VELCRO TAPE TO SIZE**
Cut the Velcro tape to size, using a pair of scissors. Mark the middle (M) of the window seal (Fig. 1). Mark the middle of the window frame and the casement (Fig. 2-4) (Figure 2 shows an open window, Figure 3 a tilted window and Figure 4 an open skylight).
- 13.3. VELCRO TAPE TO THE WINDOW FRAME**
Adhere the Velcro tape to the window frame around the window. Then adhere the Velcro tape fully around the window. Stick the Velcro tape to the front side (in most cases 1 cm wide) of the casement or to the inner surface of the casement (where the window handle is attached).
CAUTION: DO NOT adhere the Velcro tape on the window.
- 13.4. SEALING WINDOW TO WINDOW FRAME**
Adhere the narrow side of the window seal to the Velcro tape on the window frame. Work from the centre and fully adhere the narrow side all the way around. First fasten side A, then side B, starting in the middle and working all the way to the left and right.
IMPORTANT! When fastening, point A must be exactly opposite point B.
- 13.5. SEALING THE WINDOW**
Leave the window ajar and adhere the wide side of the window seal to the Velcro tape of the window.
CAUTION: Leave sufficient space, so that the window seal will not get jammed
- 13.6. OPENING THE WINDOW SEAL**
Open the zip of the window seal approximately 50 cm. Open the zip preferably at the positions marked with "S" and attach the exhaust air hose.
- 13.7. ATTACHING THE AIR DISCHARGE**
Insert the air discharge hose of the air conditioning system through the hole in the window seal and close the zip until the air discharge hose is properly secured
- 13.8. CLOSING THE WINDOW**
If you want to close your window, simply detach the cloth from the Velcro tape. When closing the window take care that the seal is not jammed between the casement and window frame.
NOTE: This window seal ensures that the room remains cool for a longer period of time and keeps insects and mosquitoes out

POLYESTER
MATERIAL

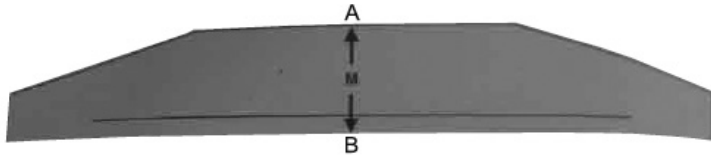

M = MIDDLE

fig.1

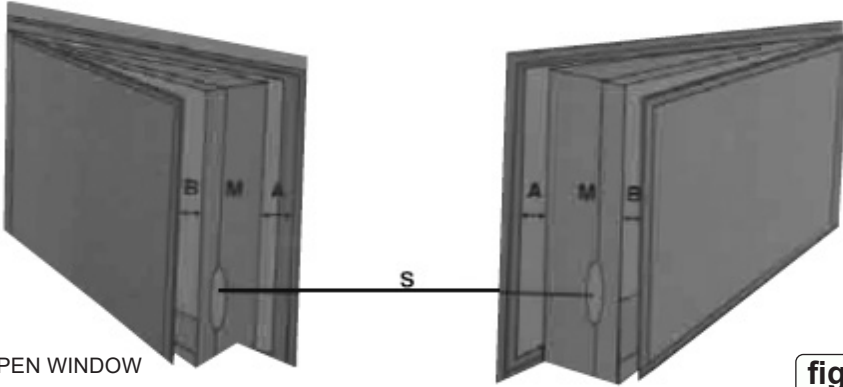

OPEN WINDOW

fig.2

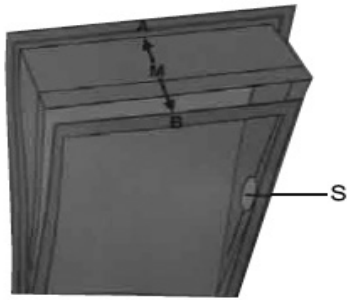

TILTED WINDOW

fig.3

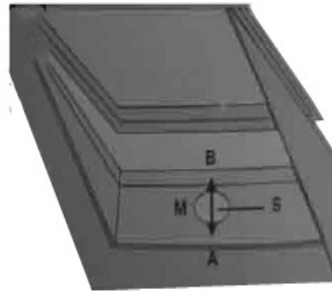

OPEN SKYLIGHT

fig.4



fig.5



fig.6

13.9. The installed item will resemble fig.5 and fig.6.



ENVIRONMENT PROTECTION

Recycle unwanted materials instead of disposing of them as waste. All tools, accessories and packaging should be sorted, taken to a recycling centre and disposed of in a manner which is compatible with the environment. When the product becomes completely unserviceable and requires disposal, drain any fluids (if applicable) into approved containers and dispose of the product and fluids according to local regulations.



WEEE REGULATIONS

Dispose of this product at the end of its working life in compliance with the EU Directive on Waste Electrical and Electronic Equipment (WEEE). When the product is no longer required, it must be disposed of in an environmentally protective way. Contact your local solid waste authority for recycling information.



BATTERY REMOVAL: REMOVE BATTERY FROM REMOTE

Under the Waste Batteries and Accumulators Regulations 2009, Jack Sealey Ltd are required to inform potential purchasers of products containing batteries (as defined within these regulations), that they are registered with Valpak's registered compliance scheme. Jack Sealey Ltd Batteries Producer Registration Number (BPRN) is BPRN00705.

Note: It is our policy to continually improve products and as such we reserve the right to alter data, specifications and component parts without prior notice. Please note that other versions of this product are available. If you require documentation for alternative versions, please email or call our technical team on technical@sealey.co.uk or 01284 757505.

Important: No Liability is accepted for incorrect use of this product.

Warranty: Guarantee is 12 months from purchase date, proof of which is required for any claim.

Sealey Group, Kempson Way, Suffolk Business Park, Bury St Edmunds, Suffolk. IP32 7AR

 **01284 757500**

 **sales@sealey.co.uk**

 **www.sealey.co.uk**