

Thank you for purchasing a Sealey product. Manufactured to a high standard this product will, if used according to these instructions and properly maintained, give you years of trouble free performance.

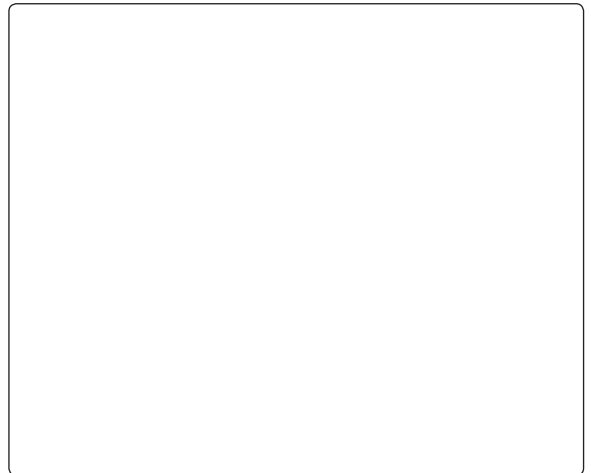

IMPORTANT: PLEASE READ THESE INSTRUCTIONS CAREFULLY. NOTE THE SAFE OPERATIONAL REQUIREMENTS, WARNINGS AND CAUTIONS. USE THE PRODUCT CORRECTLY AND WITH CARE FOR THE PURPOSE FOR WHICH IT IS INTENDED. FAILURE TO DO SO MAY CAUSE DAMAGE AND/OR PERSONAL INJURY AND WILL INVALIDATE THE WARRANTY. PLEASE KEEP INSTRUCTIONS SAFE FOR FUTURE USE.



1. SAFETY INSTRUCTIONS

1.1 ELECTRICAL SAFETY

WARNING! ELECTRICAL INSTALLATION OF COMPRESSOR TO A 3-PHASE 415VOLT SUPPLY MUST ONLY BE CARRIED OUT BY A QUALIFIED ELECTRICIAN.

Make sure the power supply cable is correctly connected to the earth. It is the user's responsibility to read, understand and comply with the following:

You must check all electrical equipment and appliances to ensure they are safe before using. You must inspect power supply leads, plugs and all electrical connections for wear and damage. You must ensure the risk of electric shock is minimised by the installation of appropriate safety devices. An RCCB (Residual Current Circuit Breaker) should be incorporated in the main distribution board.

You must also read and understand the following instructions concerning electrical safety.

- 1.1.1. The **Electricity At Work Act 1989** requires all portable electrical appliances, if used on business premises, to be tested by a qualified electrician, using a Portable Appliance Tester (PAT), at least once a year.
- 1.1.2. The **Health & Safety at Work Act 1974** makes owners of electrical appliances responsible for the safe condition of the appliance and the safety of the appliance operator. **If in any doubt about electrical safety, contact a qualified electrician.**
- 1.1.3. Ensure insulation on all cables and the product itself is safe before connecting to mains power supply.
- 1.1.4. Ensure that cables are always protected against short circuit and overload.
- 1.1.5. Regularly inspect power supply, leads, plugs and all electrical connections for wear and damage, especially power connections, to ensure that none are loose.
- 1.1.6. **Important:** Ensure the voltage marked on the product is the same as the electrical power supply to be used. A three phase plug must be fitted to this machine.
- 1.1.7. **DO NOT** pull the powered appliance by the power cable.
- 1.1.8. **DO NOT** pull power plugs from sockets by the power cable.
- 1.1.9. **DO NOT** use worn or damage leads, plugs or connections. Immediately replace or have repaired by a qualified electrician.
- 1.1.10. **This product must be fitted with a 3-phase plug according to the diagram, and will require a minimum of 16Amps per phase, (preferably 32Amp) electrical supply. You must contact a qualified electrician to ensure an appropriately fused supply is available.**

Connect GREEN/YELLOW wire to earth (E) terminal.

Connect the live wires to live 1, 2 and 3. Check for the correct direction of rotation (see arrow on belt cage) to confirm correct wiring of 3-phase plug when you first run the compressor.

When completed, check that there are no bare wires, that all wires have been connected correctly, that the cable external insulation extends beyond the cable restraint and that the restraint is tight.

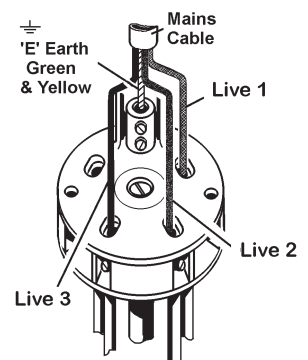

1.2 GENERAL SAFETY INSTRUCTIONS

- ✓ Familiarise yourself with the application and limitations of the compressor.
- ✓ Ensure that the compressor is in good order and condition before use. If in any doubt do not use the unit and contact an electrician/ service agent.
- IMPORTANT!** The compressor must be installed and commissioned by qualified personnel.
- ❑ **WARNING! Compressor must only be serviced by an authorised agent. DO NOT tamper with, or attempt to adjust, pressure switch or safety valve.**
- ✓ Before moving or maintaining the compressor ensure it is unplugged from the mains supply and that the air tank pressure has been vented.
- ✓ Only use recommended attachments and parts. To use non-recommended items may be dangerous and will invalidate your warranty.
- ✓ Read the instructions regarding any accessory used with the compressor. Ensure the safe working pressure of any air appliance used exceeds the compressor regulator. If using a spray gun, check the area selected for spraying is provided with an air change system or ventilation.
- ✓ Ensure the air supply valve is turned off before disconnecting the air supply hose.
- ✓ Use the compressor in a well ventilated area and ensure it is placed on a firm surface away from any heat sources.
- ✓ Keep tools and other items away from the compressor when it is in use and keep area clean and clear of unnecessary items.
- ✓ Ensure the air hose is not tangled, twisted or pinched.
- ✓ Keep children and unauthorised persons away from the working area.
- ✗ **DO NOT** dis-assemble compressor for any reason. The unit must be checked by qualified personnel only.
- ✗ **DO NOT** use the compressor outdoors, or in damp, or wet, locations and **DO NOT** operate within the vicinity of flammable liquids, gases or solids.
- ✗ **DO NOT** touch compressor cylinder, cylinder head or pipe from head to tank as these may be hot and will remain so for some time after shutdown.
- ✗ **DO NOT** attempt to move the compressor by pulling the air tool hose.
- ✗ **DO NOT** use this product to perform a task for which it has not been designed.
- ✗ **DO NOT** operate the compressor with the belt guard removed.
- ✗ **DO NOT** deface the certification plate attached to the end of the compressor tank.
- ✗ **DO NOT** cover compressor or restrict air flow around the machine whilst operating.
- ▲ **DANGER! DO NOT direct the output jet of air towards people or animals.**
- ✗ **DO NOT** operate the compressor without an inlet air filter.
- ✗ **DO NOT** allow anyone to operate the compressor unless they have received full instructions and adequate training.
- ❑ **WARNING! The air tank is a pressure vessel and the following safety measures apply:**
- ✗ **DO NOT tamper with the safety valve and DO NOT modify or alter the tank in any way, DO NOT strap anything to the tank.**
- ✗ **DO NOT subject the tank to impact, vibration or to heat and DO NOT allow contact with abrasives or corrosives.**
- ✗ **DO drain condensation from tank daily, inspect inside walls for corrosion every three months and have a detailed tank inspection carried out annually. Tank shell must not fall below the certified thickness at any point.**
- ❑ **WARNING! If an electrical fuse blows, ensure that it is replaced with one of identical type and rating.**
- ✓ When not in use, store the compressor carefully in a safe, dry, childproof location.
- ✓ When the compressor is not in use, it should be switched off, isolated from the mains supply and the air drained from the tank.

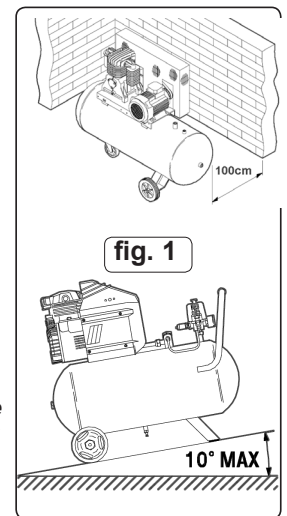

2. INTRODUCTION & SPECIFICATIONS

2.1 INTRODUCTION

Heavy-duty three phase compressors suitable for the professional workshop. Pumps have heavy-duty full cast cylinders capped by alloy heads for improved heat dissipation and long life. Heavy-duty drive guards protect belt and flywheel that is designed to force air over the pump to aid cooling. Supplied with full CE certification, test certificates and operation/maintenance manual.

The SAC62710B model is supplied with a Star Delta Starter which must be used to connect to the power supply in order to comply with current legislation.

2.2 SPECIFICATIONS

	Motor Output hp	Voltage/Phase	Input Current Amp	Speed Rpm	Air Displacement Cfm/Lm	Max Free Air Delivery cfm/ Lm	Max. Pressure psi/bar	Receiver Capacity Ltr	Dimension (WxDxH) mm	Weight kg	Noise dB.A	Noise LwA
SAC42055B	5.5	415/3	32	1490	20.5/580	14.9/422	145/10	200	1460x610x1000	136	76	96
SAC52775B	7.5	415/3	32	1280	29.7/841	21.5/609	145/10	270	1600x500x1040	138	77	97
SAC62710B	10	415/3	32	1080	38.6/1093	28/793	145/10	270	1600x500x1125	165	77	97

3. PREPARATION

- 3.1 Remove compressor from packaging and inspect for any shortages or damage. If anything is found to be missing or damaged contact your supplier.
- 3.2 Save the packing material for future transportation of the compressor. We recommend that you store the packing in a safe location, at least for the period of the guarantee. Then, if necessary, it will be easier to send the compressor to the service centre.
- 3.3 The compressor should be operated on a flat surface, or one that does not exceed 10° either transversely or longitudinally (fig.1) and should be in a position that allows good air circulation around the unit (at least a 100cm gap).
- 3.4 Check oil level, consulting the reference marks on the stick (fig.2 + fig.2a) or the oil level inspection window depending on model. Use only synthetic oil (see maintenance section for oil specification).
- 3.5 Confirm the mains voltage corresponds with the voltage shown on compressor data plate. Have a qualified electrician wire in accordance with Section 1.1. and check that the motor operates in the correct direction. SAC62710B has a control box which requires mounting to a suitable wall and connecting to the mains by a qualified electrician.
- 3.6 When fully installed, start the compressor and ensure that everything is in good working order before operational use. **Check the direction of rotation (see arrow on motor) to confirm correct wiring of 3-phase plug. Re-check oil levels.**

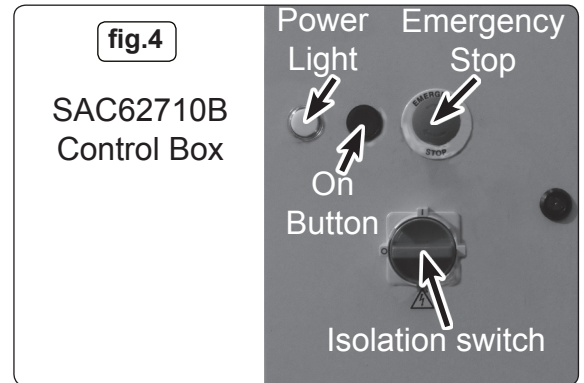
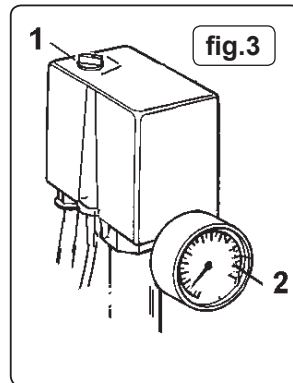
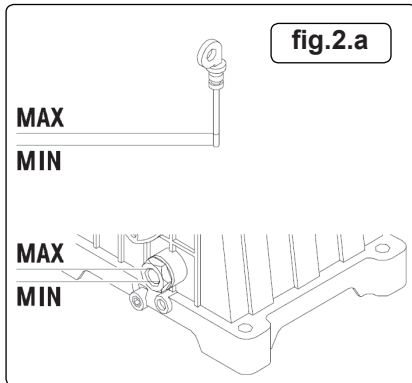
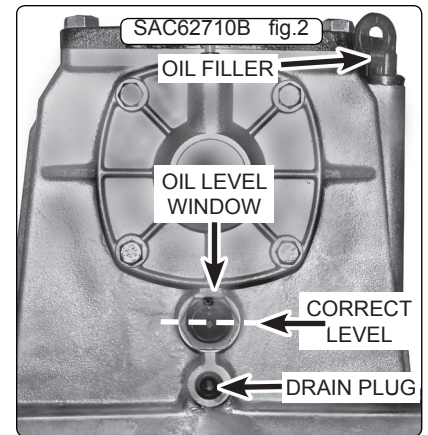
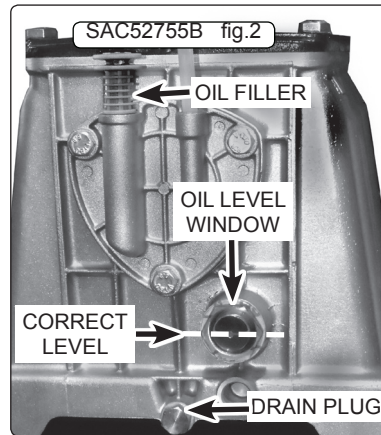
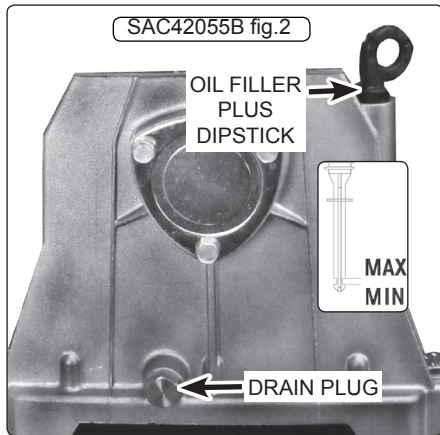

4. OPERATION

- ❑ **WARNING! Ensure that you have read, understood and apply Section 1 safety instructions.**
- ❑ **IMPORTANT!** The use of extension leads to connect these compressors to the mains is not recommended as the resulting voltage drop reduces motor, and therefore pump performance which may cause damage to your compressor.

NOTE: Take care when selecting tools for use with the compressor. Air tool manufacturers normally express the volume of air required to operate a tool in cubic feet per minute (cfm). This refers to free air delivered by the compressor ('air out') which varies according to the pressure setting. Do not confuse this with the compressor displacement which is the air taken in by the compressor ('air in'). 'Air out' is always less than 'air in' due to losses within the compressor.

4.1 STARTING THE COMPRESSOR (SAC42055B & SAC52775B)

- 4.1.1 Check that the ON/OFF switch (fig.3.1) is OFF in the "O" position.
- 4.1.2 Plug mains lead into mains supply and start the compressor by moving the pressure switch to the ON 'I' position. **Check the direction of rotation (see arrow on belt cage) to confirm correct wiring of 3-phase plug.**
- 4.1.3 When starting the compressor for the first time, leave it running with no air tools connected to the air outlet. Make sure that pressure in the tank rises and that the compressor stops automatically when the maximum pressure value allowed - written on the plate and shown on the gauge is achieved. The compressor will now operate automatically. The pressure switch stops the motor when the maximum tank pressure is reached and restarts it when the pressure falls below the minimum threshold - approx. 2bar (29psi) less than the maximum pressure.
- 4.1.4 Stop the compressor by moving the pressure switch (fig.3.1) to the "O" position. The compressed air inside the compressor head will flow out, making the restart easier and preventing the motor from being damaged. **DO NOT**, other than in an emergency, stop the compressor by switching off the mains power, or by pulling the plug out, as the pressure relief will not then operate and motor damage may result upon restart. When the compressor runs correctly and is stopped correctly there will be:
 - (a) a whistle of compressed air when the motor stops.
 - (b) a protracted whistle (about 20-25 seconds) when the compressor starts with no pressure in the tank.

4.2 STARTING THE COMPRESSOR (SAC62710B)

- 4.2.1 Turn the pressure switch (fig.3.1) to the "I" position. Turn the Isolation Switch (fig.4) to the "I" position, power on is signalled by the indicator light. Press the "on" button (fig.4) to start the compressor. **Check the direction of rotation (see arrow on belt cage) to confirm correct wiring of 3-phase plug.** Then follow procedure 4.1.4 - 4.1.5.
- 4.2.2 Stop the compressor by moving turning the Isolation Switch (fig.4) to the "O" position. The compressed air inside the compressor head will flow out, making the restart easier and preventing the motor from being damaged. **DO NOT** other than in an emergency, stop the compressor by switching off the mains power as the pressure relief will not then operate and motor damage may result upon restart.

NOTE: a) If the motor does not cut in and out, but runs continuously when using an air appliance, the capacity of the compressor may be too small for the equipment or tool.

b) The gauge (fig.3.2) indicates the pressure inside the main tank, NOT the pressure supplied to the air equipment. Should the pressure in the main tank exceed the pre-set switch maximum, a safety valve will activate.

WARNING! For this reason DO NOT tamper with, or adjust, the switch or safety valve.

5. MAINTENANCE

In order to keep the compressor in good working condition, periodic maintenance is essential.

IMPORTANT! Failure to carry out maintenance tasks may invalidate the warranty on your compressor.

- ❑ **WARNING! Before performing any maintenance operation, switch off the compressor, disconnect from electricity supply and release all air from the tank. (Except for 5.3a)**

5.1 OPERATIONS TO BE CARRIED OUT AFTER THE FIRST 50 WORKING HOURS:

- a) Check that all bolts/nuts are tight, particularly those retaining the crankcase and cylinder head.
- b) Replace the lubricating oil - see para 5.4.

5.2 OPERATIONS TO BE CARRIED OUT WEEKLY:

- a) Drain condensation by opening the valve located under the tank (fig.5). Place a container under the valve and open the valve by turning anticlockwise.

- ❑ **WARNING! Take care if there is compressed air in the tank as water could flow out with considerable force. Recommended pressure 1 - 2bar max.**
- b) Check oil level and if necessary, top up.

5.3 OPERATIONS TO BE CARRIED OUT EVERY 50 HOURS:

(or more frequently, if the compressor operates in a very dusty atmosphere):

- a) Turn off the compressor and remove the filter element (fig.6). Using stored air from it's tank, clean the filter with compressed air. (Wear eye protection and DO NOT direct air towards the body or hands). DO NOT operate the compressor without the filter as foreign bodies or dust could seriously damage the pump. Replace the filter element.
- b) Check for oil leaks.

5.4 OPERATIONS TO BE CARRIED OUT EVERY 100 HOURS:

- a) Check the automatic cut-out at max. pressure and the automatic cut-in at 2bar below.

5.5 OPERATIONS TO BE CARRIED OUT EVERY 400 HOURS:

- a) Replace the lubricating oil. For oil specifications see 5.6. Remove the dipstick/breather plug then unscrew oil drain plug (fig.2), draining the oil into a container. Drain when the compressor is hot so that oil drains rapidly and completely. Replace oil drain plug and refill through the dipstick/breather aperture. Do not overfill. Replace dipstick.
- b) Replace air filter.
- c) Check all tube fittings and electrical connections.
- d) Inspect pressure tank inside and out for damage or corrosion.

- ❑ **WARNING! Never mix different oils and do not use non-detergent/low quality oils as the compressor may be damaged.**

- ❑ **WARNING! Dispose of waste oil only in accordance with local authority requirements.**

5.6 RECOMMENDED OILS

Synthetic oil suitable for temperatures ranging from -5°C to 45°C, viscosity 5W50. We do not recommend using mineral oil in these compressors.

Part No.	Qty.	Description
FSO1	1ltr x 12	Compressor oil fully synthetic
FSO1S	1ltr x 1	Compressor oil fully synthetic
FSO5	5ltr x 1	Compressor oil fully synthetic

5.7 SCHEDULED MAINTENANCE TABLES

Maintenance Operations	Weekly	50hrs	100hrs	400hrs
Drain condensation	●			
Check oil level	●			
Clean intake filter		●		
Check for oil leaks		●		
Replace oil				●
Check cut-out			●	
General cleaning of compressor			●	
Replace air filter				●
Check tube fittings and electrical connections				●
Internal & external inspection of tank				●

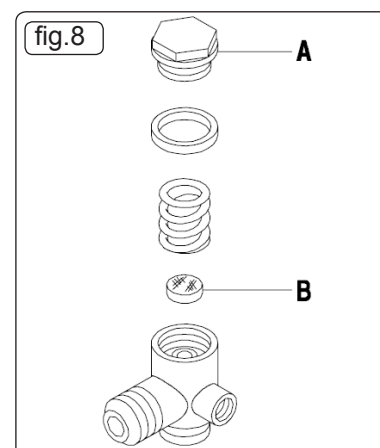
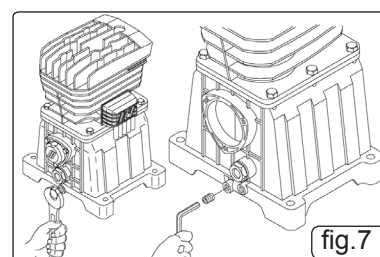
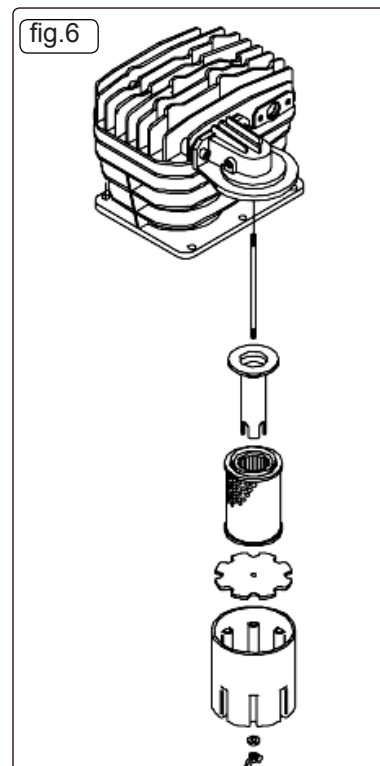
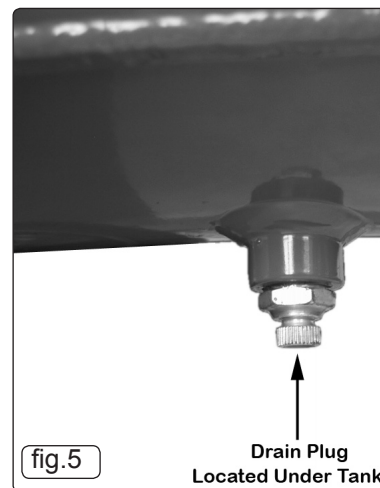

6. TROUBLE SHOOTING

Fault	Cause	Remedy
Pressure drop in the tank.	Air leaks at connections.	Run compressor to max. pressure, switch off. Brush soap solution over connections and look for bubbles. Tighten connections showing leaks. If problem persists contact Authorised Service Agent.
Pressure switch valve leaks when compressor is idle.	Non-return valve seal defective.	Discharge all tank pressure. Referring to fig.8, unscrew valve cap 'A'. Clean rubber disc 'B' and its seat. Refit all parts accurately.
Compressor stops and does not restart.	Power failure. Motor failure.	Check electricity supply and fuse. Contact Authorised Service Agent.
Compressor does not stop at max pressure.	Pressure switch fault.	Contact Authorised Service Agent.
Compressor does not reach max pressure.	Filter clogged. Head gasket or valve fault.	Replace filter element. Contact Authorised Service Agent.
Compressor noisy with metallic knock.	Low oil level. Bearing or piston damage.	Turn off and top up oil immediately. Contact Authorised Service Agent.

IMPORTANT WARNING - Air contaminants taken into the compressor will affect optimum performance. Example: Body filler dust or paint over-spray will clog the pump intake filter and may cause internal damage to pump/motor components. Please note that any parts damaged by any type of contamination will not be covered by warranty.

Parts support is available for this product. To obtain a parts listing and/or diagram, please log on to www.sealey.co.uk, email sales@sealey.co.uk or phone 01284 757500.

NOTE: It is our policy to continually improve products and as such we reserve the right to alter data, specifications and component parts without prior notice.

IMPORTANT: No liability is accepted for incorrect use of this product.

WARRANTY: Guarantee is 12 months from purchase date, proof of which will be required for any claim.

INFORMATION: For a copy of our latest catalogue and promotions call us on 01284 757525 and leave your full name and address, including postcode.



Sole UK Distributor, Sealey Group,
Kempson Way, Suffolk Business Park,
Bury St. Edmunds, Suffolk,
IP32 7AR



01284 757500



www.sealey.co.uk



01284 703534



sales@sealey.co.uk

