



Platinum Series





**OIL FREE
AIR COMPRESSOR
INSTRUCTION MANUAL**

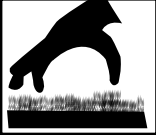

IMPORTANT SAFETY INSTRUCTIONS AND GUIDELINES

Save all instructions

WARNING

Improper operation or maintenance of this product could result in serious injury and/or property damage. Read and understand all of the warnings and safety instructions provided before using this equipment.

<p>CAUTION</p>	<p>The air compressor should be operated on a dedicated 10-amp circuit. If the circuit does not have 10 free amps available, a larger circuit must be used. Always use more air hose before utilizing extension cords. Low voltage could cause damage to the motor.</p>
<p>Risk of Moving Parts</p> 	<p>If the air compressor is in operation, all guards and covers should be attached or installed correctly. If any guard or cover has been damaged, do not operate the equipment until the proper personnel have correctly repaired the equipment. The power cord should be free of any moving parts, twisting and/or crimping while in use and while in storage.</p>
<p>Risk of Burns</p> 	<p>There are surfaces on your air compressor that while in operation and there-after can cause serious burns if touched. The equipment should be allowed time to cool before any maintenance is attempted. Items such as the compressor pump and the outlet tube are normally hot during and after operation.</p>
<p>Risk of Falling</p> 	<p>Operation of the air compressor should always be in a position that is stable. Never use the air compressor on a rooftop or elevated position that could allow the unit to fall or be tipped over. Use additional air hose for elevated jobs.</p>
<p>Risk from Flying Objects</p> 	<p>Always wear approved safety glasses with side shields when the air compressor is in use. Turn off the air compressor and drain the air tank before performing any type of maintenance or disassembly of the hoses or fittings. Never point any nozzle or sprayer toward any part of the body or at other people or animals.</p>
<p>Risk to Breathing</p> 	<p>Avoid using the air compressor in confined areas. Always have adequate space (30 cm) on all sides of the air compressor. Also keep children, pets, and others out of the area of operation. This air compressor does not provide breathable air for anyone or any auxiliary breathing device. Spraying material will always need to be in another area away from the air compressor to not allow intake air to damage the air compressor filter.</p>
<p>Risk of Electrical shock</p> 	<p>Never utilize the air compressor in the rain or wet conditions. Any electrical issues or repairs should be performed by authorized personnel such as an electrician and should comply with all national and local electrical codes. The air compressor should also have the proper three prong grounding plug, correct voltage, and adequate fuse protection.</p>

<p>Risk of Explosion or fire</p> 	<p>Never operate the compressor near combustible materials, gasoline or solvent vapors. If spraying flammable materials, locate the air compressor at least 50m away from the spray area. Never operate the air compressor indoors or in a confined area.</p>
<p>Risk of Bursting</p> 	<p>Always drain the air compressor tank daily or after each use. If the tank develops a leak, then replace the air compressor. Never use the air compressor after a leak has been found or try to make any modifications to the tank. Never modify the air compressor's factory settings which control the tank pressure or any other function.</p>

PARTS & FEATURES

Drain Valve: Used to drain condensation from the air tank. Located at bottom of tank. (52)

Motor Thermal Overload: The motor has an automatic thermal overload protector. If the motor overheats, this protector will shut off the motor. The motor must be allowed 30 minutes to cool before restarting.

Pressure Switch: This controls the power to the motor and also the cut-in/cut-out pressure settings. This switch serves as the Auto-On/Off positions for the unit. (45)

Air Intake Filter: Provides clean air to the pump and must always be kept free of debris. Check on a daily basis or before each use. (38)

Check Valve: When the pump is not in operation the valve closes to retain air pressure inside the tank. (60)

Pressure Relief Valve: The pressure relief valve located on the side of the pressure switch is designed to automatically release compressed air when the air compressor reaches cut-out pressure. The release air should only escape momentarily and the valve should then close.

Tank Safety Valve: Used to allow excess tank pressure to escape into the atmosphere. This valve should only open when the tank pressure is above the maximum rated pressure. (46)

Outlet Pressure Gauge: Indicates the outgoing air pressure to the tool and is controlled by the regulator. (42)

Tank Pressure Gauge: Indicates the reserve air pressure in the tank. (43)

Regulator: The regulator controls the air pressure coming from the air tank. To increase the pressure, turn the knob clockwise and to decrease the pressure turn the knob counterclockwise. (41)

PARTS DIAGRAM

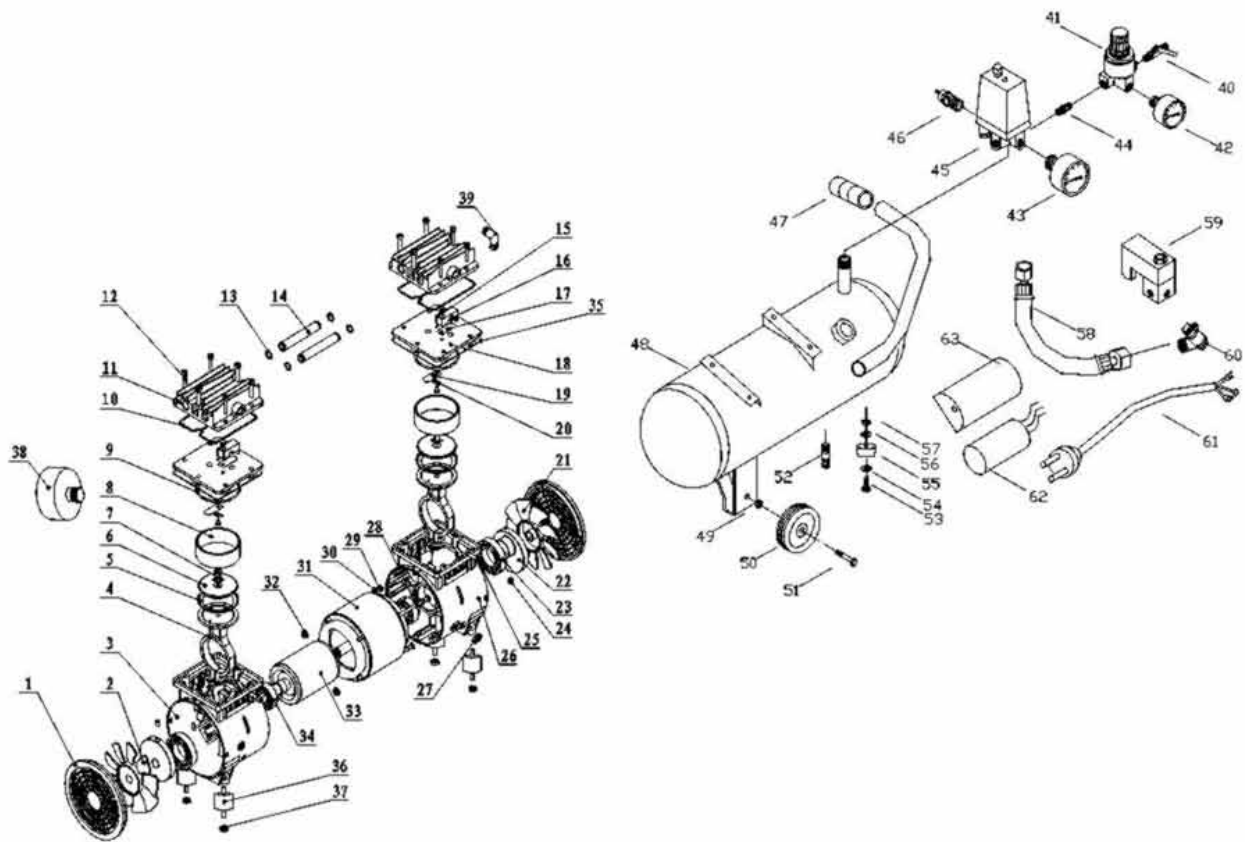

- | | | | |
|----------------------|---------------------|---------------------------|----------------------|
| 1. Cover | 17. Reed Valve | 33. Rotor | 49. Wheel Nut |
| 2. Left Fan | 18. Reed Valve | 34. Bearing 6203-2z | 50. Wheel |
| 3. Left Crankcase | 19. Valve Plate | 35. Adjusting Washer | 51. Bolt (Axle) |
| 4. Connecting Rod | 20. Washer | 36. Rubber Mount | 52. Tank Drain Cock |
| 5. Piston Cup | 21. Right Fan | 37. Spring Washer | 53. Bolt |
| 6. Binder Plate | 22. Shaft Seal | 38. Air Filter | 54. Washer |
| 7. Con Rod Bolt | 23. Bearing 6908-2z | 39. Elbow | 55. Cushion Foot |
| 8. Cylinder | 24. Bearing Bolt | 40. Deflating Tap | 56. Washer |
| 9. Cylinder Seal | 25. Bearing Bolt | 41. Regulator | 57. Nut |
| 10. Head Seal | 26. Right Crankcase | 42. Outlet Pressure gauge | 58. Pipe |
| 11. Cylinder Head | 27. Protection Ring | 43. Tank Pressure gauge | 59. Actuated Valve |
| 12. Head Bolt | 28. Assembly Bolt | 44. Connector | 60. Non Return Valve |
| 13. 'O' Ring | 29. Assembly Bolt | 45. Pressure Switch | 61. Plug and Lead |
| 14. Transfer Pipe | 30. Spring Washer | 46. Safety Valve | 62. Capacitor |
| 15. Valve Plate Bolt | 31. Stator | 47. Handle | 63. Capacitor cover |
| 16. Valve Block | 32. Assembly Nut | 48. Tank | |

INSTALLATION & ASSEMBLY

WARNING

The air compressor should be turned off and unplugged from the power source before any maintenance is performed as well as the air bled from the tank and the unit allowed time to cool. Personal injuries could occur from moving parts, electrical sources, compressed air or hot surfaces.

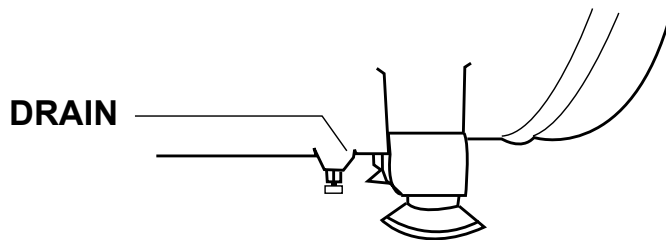

Location of the Air Compressor

The air compressor should always be located in a clean, dry, and well-ventilated environment. The unit should have at minimum, 30cm of space on each side. The air filter intake should be free of any debris or obstructions. Check the air filter on a daily basis to be sure it is clean and in working order.

Grounding Instructions

This product should be grounded. In the event of an electrical short circuit, grounding reduces the risk of electric shock by providing an escape wire for the electric current. This product is equipped with a cord having a grounding wire with an appropriate grounding plug. The plug must be plugged into an outlet that is properly installed and grounded in accordance with all local codes and ordinances. Check with a qualified electrician or service personnel if these instructions are not completely understood or if in doubt as to whether the tool is properly grounded.

WARNING

Improper installation of the grounding plug will result in a risk of electric shock. If repair or replacement of the cord or plug is necessary, do not connect the grounding wire to either flat blade terminal. The wire with insulation having an outer surface that is green with or without yellow stripes is the grounding wire. Check with a qualified electrician or serviceman if the grounding instructions are not completely understood, or if in doubt as to whether the product is properly grounded. Do not modify the plug provided; if it will not fit the outlet, have the proper outlet installed by a qualified electrician. This product is for use on a circuit having a nominal rating of 230 volts and is factory-equipped with a specific electric cord and plug to permit connection to a proper electric circuit. Make sure that the product is connected to an outlet having the same configuration as the plug. No adapter should be used with this product. If the product must be reconnected for use on a different type of electric circuit, qualified service personnel should make the reconnection.

Extension Cords

Make sure your extension cord is in good condition. When using an extension cord, be sure to use one heavy enough to carry the current your product will draw. An undersized cord will cause a drop in line voltage resulting in loss of power and overheating.

Break in Procedures

No break in procedure is required by the user. This product is factory tested to ensure proper operation and performance. Compressor must always be turned ON or OFF using pressure switch. Never turn machine OFF or ON using power source

OPERATION PROCEDURES

Daily Start-Up Procedures

1. Set the Auto-On/Off lever to the off position.
2. Check the air compressor visually for any damage or obstruction.
3. Close the drain valve.
4. Plug the power cord into the proper receptacle.
5. Turn the Auto-on/Off lever to the On-Auto position and the compressor will start and build air pressure in the tank to cut-out pressure and then shut off automatically.
6. Adjust the regulator to a PSI setting that is needed for your application and be sure it is within the safety standards required to perform the task. If using a pneumatic tool, the manufacturer should have recommendations in the manual for the particular tool on operating PSI settings.
7. The air compressor is now ready for use.

MAINTENANCE

NOTE: Qualified service personnel should perform any service procedure not covered in the maintenance schedule below.

ITEMS TO CHECK/CHANGE	Before Each Use or Daily
Check Tank Safety Valve	X
Overall Unit Visual Check	X
Check Air Filter (More frequently in dusty or humid environments)	X

CAUTION

To ensure efficient operation and longer life of the air compressor unit, a routine maintenance schedule should be followed. The following schedule is geared toward a consumer whose compressor is used in a normal working environment on a daily basis. If necessary, the schedule should be modified to suit the condition under which your compressor is used. The modifications will depend upon the hours of operation and the working environment. Air compressors used in an extremely dirty and/or hostile environment will require a greater frequency of all maintenance checks.

Daily Shut-Down Procedures

1. Set the Auto-On/Off lever to the Off position.
2. Unplug the power cord from the receptacle.
3. Set the outlet pressure to zero on the regulator.
4. Remove any air tools or accessories.
5. Open the drain valve allowing air to bleed from the tank. After all of the air has bled from the tank, close the drain valve to prevent debris buildup in the valve.

CAUTION

When draining the tank, always use ear and eye protection. Drain the tank in a suitable location; condensation will be present in most cases of draining.

WARNING

Water that remains in the tank during storage will corrode and weaken the air tank, which could cause the tank to rupture. To avoid serious injury, be sure to drain the tank after each use or daily.

WARNING

The air compressor should be turned off and unplugged from the power source before any maintenance is performed as well as the air bled from the tank and the unit allowed time to cool. Personal injuries could occur from moving parts, electrical sources, compressed air or hot surfaces.

STORAGE

For storing the air compressor, be sure to do the following:

1. Turn the unit off and unplug the power cord from the receptacle.
2. Remove all air hoses, accessories, and air tools from the air compressor.
3. Perform the daily maintenance schedule.
4. Open the drain valve to bleed all air from the tank.
5. Close the drain valve.
6. Store the air compressor in a clean and dry location.

TROUBLESHOOTING GUIDE



The air compressor should be turned off and unplugged from the power source before any maintenance is performed as well as the air bled from the tank and the unit allowed time to cool. Personal injuries could occur from moving parts, electrical sources, compressed air, or hot surfaces.

Problem	Possible Correction
Air leaks at the check valve or at the pressure relief valve.	A defective check valve results in a constant air leak at the pressure release valve when there is pressure in the tank and the compressor is shut off. Drain the tank, then remove and clean or replace the check valve.
Air leaks between head and cylinder.	Be sure of proper torque on head bolts. If leak remains, contact a service technician.
Air leak from safety valve	Operate the safety valve manually by pulling on the ring. If the valve continues to leak when in the closed position, it should be replaced.
Pressure reading on the regulated pressure gauge drops when an accessory is used.	If there is an excessive amount of pressure drop when the accessory is used, replace the regulator. NOTE: Adjust the regulated pressure under flow conditions (while accessory is being used). It is normal for the gauge to show minimal pressure loss during initial use of the tool.
Excessive tank pressure.	Move the Auto-On/Off lever to the Off position. If the unit doesn't shut off, unplug it from the power source and contact a service technician.
Motor will not start.	Make sure power cord is plugged in and the switch is on. Inspect for the proper size fuse in your circuit box. If the fuse was tripped reset it and restart the unit. If repeated tripping occurs, replace the check valve or contact your service technician.
Excessive moisture in the discharge air.	Remove the water in the tank by draining after each use. High humidity environments will cause excessive condensation. Utilize water filters on your air line. NOTE: Water condensation is not caused by compressor malfunction. Be sure the compressor's air output is greater than your tool's air consumption rate.
Air leaks from the tank body or tank welds.	Never drill into weld or otherwise modify the air tank or it will weaken. The tank can rupture or explode. Compressor cannot be repaired. Discontinue use of the air compressor.