

Thank you for purchasing a Sealey product. Manufactured to a high standard this product will, if used according to these instructions and properly maintained, give you years of trouble free performance.



IMPORTANT: PLEASE READ THESE INSTRUCTIONS CAREFULLY. NOTE THE SAFE OPERATIONAL REQUIREMENTS, WARNINGS AND CAUTIONS. USE THE PRODUCT CORRECTLY AND WITH CARE FOR THE PURPOSE FOR WHICH IT IS INTENDED. FAILURE TO DO SO MAY CAUSE DAMAGE AND/OR PERSONAL INJURY AND WILL INVALIDATE THE WARRANTY. PLEASE KEEP INSTRUCTIONS SAFE FOR FUTURE USE.

1. SAFETY INSTRUCTIONS

1.1. ELECTRICAL SAFETY

- **WARNING! ELECTRICAL INSTALLATION OF COMPRESSOR TO A 3-PHASE 415 VOLT SUPPLY MUST ONLY BE CARRIED OUT BY A QUALIFIED ELECTRICIAN. Make sure the power supply cable is correctly connected to the earth. It is the user's responsibility to read, understand and comply with the following:**

You must check all electrical equipment and appliances to ensure they are safe before using. You must inspect power supply leads, plugs and all electrical connections for wear and damage. You must ensure the risk of electric shock is minimised by the installation of appropriate safety devices. An RCCB (Residual Current Circuit Breaker) should be incorporated in the main distribution board. **You must** also read and understand the following instructions concerning electrical safety.

- 1.1.1. The **Electricity At Work Act 1989** requires all portable electrical appliances, if used on business premises, to be tested by a qualified electrician, using a Portable Appliance Tester (PAT), at least once a year.
- 1.1.2. The **Health & Safety at Work Act 1974** makes owners of electrical appliances responsible for the safe condition of the appliance and the safety of the appliance operator. **If in any doubt about electrical safety, contact a qualified electrician.**
- 1.1.3. Ensure insulation on all cables and the product itself is safe before connecting to mains power supply.
- 1.1.4. Ensure that cables are always protected against short circuit and overload.
- 1.1.5. Regularly inspect power supply, leads, plugs and all electrical connections for wear and damage, especially power connections, to ensure that none is loose.
- 1.1.6. **Important:** Ensure the voltage marked on the product is the same as the electrical power supply to be used. A three phase plug must be fitted to this machine.
- 1.1.7. DO NOT pull the powered appliance by the power cable.
- 1.1.8. DO NOT pull power plugs from sockets by the power cable.
- 1.1.9. DO NOT use worn or damage leads, plugs or connections. Immediately replace or have repaired by a qualified electrician.

- 1.1.10. **This product must be fitted with a 3-phase plug according to the diagram, and will require a minimum of 16 amps per phase, (preferably 32 amp) electrical supply. You must contact a qualified electrician to ensure an appropriately fused supply is available. Connect GREEN/YELLOW wire to earth (E) terminal.**

Connect BROWN wire to L1 (or R1) terminal.

Connect BLUE wire to L2 (S2) terminal.

Connect the BLACK wire to L3 (T3) terminal.

When completed, check that there are no bare wires, that all wires have been connected

correctly, that the cable external insulation extends beyond the cable restraint and that the restraint is tight.

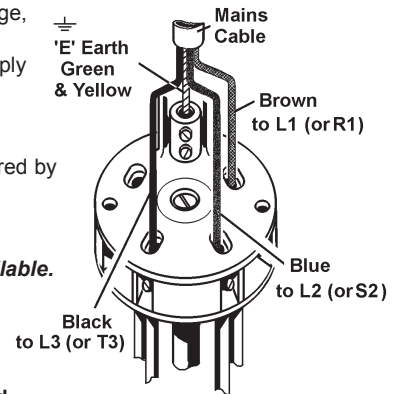

- 1.1.11. DO NOT use this product with a standard extension cable. Only use an ARMoured extension cable.

1.2. GENERAL SAFETY INSTRUCTIONS

- Familiarise yourself with the application and limitations of the compressor.
- Ensure that the compressor is in good order and condition before use. If in any doubt do not use the unit and contact an electrician/service agent.
- **IMPORTANT!** The compressor must be installed and commissioned by qualified personnel.
- **WARNING! Compressor must only be serviced by an authorised agent. DO NOT tamper with, or attempt to adjust, pressure switch or safety valve.**
- Before moving or maintaining the compressor ensure it is unplugged from the mains supply and that the air tank pressure has been vented.
- Only use recommended attachments and parts. To use non-recommended items may be dangerous and will invalidate your warranty.
- Read the instructions regarding any accessory used with the compressor. Ensure the safe working pressure of any air appliance used exceeds the compressor regulator. If using a spray gun, check the area selected for spraying is provided with an air change system or ventilation.
- Ensure the air supply valve is turned off before disconnecting the air supply hose.
- Use the compressor in a well ventilated area and ensure it is placed on a firm surface away from any heat sources.
- Keep tools and other items away from the compressor when it is in use and keep area clean and clear of unnecessary items.
- Ensure the air hose is not tangled, twisted or pinched.
- Keep children and unauthorised persons away from the working area.
- **DO NOT** dis-assemble compressor for any reason. The unit must be checked by qualified personnel only.
- **DO NOT** use the compressor outdoors, or in damp, or wet, locations and **DO NOT** operate within the vicinity of flammable liquids, gases or solids.
- **DO NOT** touch compressor cylinder, cylinder head or pipe from head to tank as these may be hot and will remain so for some time after shutdown.
- **DO NOT** attempt to move the compressor by pulling the air tool hose.
- **DO NOT** use this product to perform a task for which it has not been designed.
- **DO NOT** operate the compressor with the belt guard removed.

- **DO NOT** deface the certification plate attached to the end of the compressor tank.
- **DO NOT** cover compressor or restrict air flow around the machine whilst operating.
- ▲ **DANGER! DO NOT direct the output jet of air towards people or animals.**
- **DO NOT** operate the compressor without an inlet air filter (see fig. 6).
- **DO NOT** allow anyone to operate the compressor unless they have received full instructions and adequate training.
- ❑ **WARNING! The air tank is a pressure vessel and the following safety measures apply:**
DO NOT tamper with the safety valve and DO NOT modify or alter the tank in any way and DO NOT strap anything to the tank.
DO NOT subject the tank to impact, vibration or to heat and DO NOT allow contact with abrasives or corrosive.
DO drain condensation from tank daily, inspect inside walls for corrosion every three months and have a detailed tank inspection carried out annually. Tank shell must not fall below the certified thickness at any point.
- ❑ **WARNING! If an electrical fuse blows, ensure that it is replaced with one of identical type and rating.**
- When not in use, store the compressor carefully in a safe, dry, childproof location.

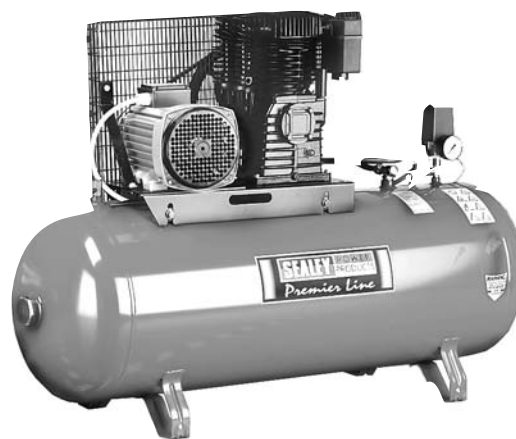

2. INTRODUCTION & SPECIFICATIONS

The premier line heavy duty compressor range is suitable for garage, bodyshop and industrial applications. These units feature a heavy-duty 3-phase electric motor and cast iron cylinders to enable slower revving giving a longer life and higher performance. Units have a 2-stage compressor head with intercooler for maximum efficiency. Fully automatic pressure switches help to keep line pressure at an optimum.

2.1. Specifications

Model	Max. Motor Output (hp)	Voltage/ Phases	Current (A)	Piston Displacement (cfm)	Maximum Free Air Delivery (cfm)	Tank Capacity (l)	Max. Pressure (psi/bar)	Noise Level (dB.A)	Weight (kg)
SA3015/55	5.5	415/3	8.5	20.4	15.5	150	160/11	90	91
SA3020/55	5.5	415/3	8.5	20.4	15.5	200	160/11	90	109
SA3027/75	7.5	415/3	11.6	31.0	25.0	270	160/11	90	180

All performance figures are ± 5%

3. PREPARATION

- 3.1. Remove compressor from packaging and inspect for any shortages or damage. If anything is found to be missing or damaged contact your supplier.
- 3.2. Save the packing material for future transportation of the compressor. We recommend that you store the packing in a safe location, at least for the period of the guarantee. Then, if necessary, it will be easier to send the compressor to the service centre.
- 3.3. Confirm the mains voltage corresponds with the voltage shown on compressor data plate. Wire in accordance with Section 1.1. and check that the motor operates in the correct direction.
- 3.4. The compressor should be operated on a flat surface, or one that does not exceed 15° either transversely or longitudinally (fig.1), and should be in a position that allows good air circulation around the unit.
- 3.5. Confirm that the oil level is at the maximum mark on the sight glass (fig.2).
- 3.6. When fully installed, start the compressor and ensure that everything is in good working order before operational use. **Check the direction of rotation (see arrow on motor) to confirm correct wiring of 3-phase plug.**

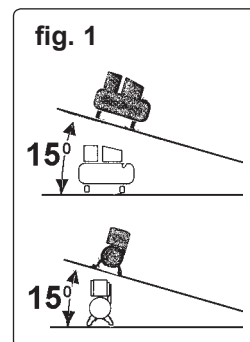
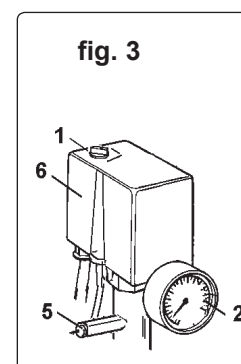

fig. 2



4. OPERATION

- ❑ **IMPORTANT**
Take care when selecting tools for use with the compressor. Air tool manufacturers normally express the volume of air required to operate a tool in cubic feet per minute (cfm). This refers to free air delivered by the compressor ('air out') which varies according to the pressure setting. Do not confuse this with the compressor displacement which is the air taken in by the compressor ('air in'). 'Air out' is always less than 'air in' and so it is important that, before choosing equipment, you study the 'Free Air Delivery' figures shown in the specifications chart, Section 2.
 - ❑ **WARNING! Ensure that you have read, understood and apply Section 1 safety instructions and that the unit is wired correctly.**
- 4.1. Make sure the main switch (fig.3.1) is in position "O", off, and the air outlet valves from the tank are closed.
 - 4.2. Plug the lead into mains supply and start the compressor by turning the main switch to "I", 'Auto'.
 - 4.3. Make sure that pressure in the tank rises and that the compressor stops automatically when the max. pressure value allowed - written on the plate and shown on the gauge (fig.3.2) - is achieved. The compressor will now operate automatically. The pressure switch stops the motor when the maximum tank pressure is reached and restarts it when pressure falls below the minimum threshold - approx. 2 bar (29psi) less than the maximum pressure.



- 4.4. Stop the compressor by turning off the main switch (fig.3.1). The compressed air inside the compressor head will flow out, making the restart easier and preventing the motor from being damaged. **DO NOT**, other than in an emergency, stop the compressor by switching off the mains socket, or by pulling the plug out, as the pressure relief will not then occur and motor damage may result upon restart. When the compressor runs correctly and is stopped correctly there will be:
- (a) a whistle of compressed air when the motor stops,
 - (b) a protracted whistle (about 20-25 seconds) when the compressor starts with no pressure in the tank.

NOTE: a) If the motor does not cut in and out, but runs continuously when using an air appliance, the capacity of the compressor may be too small for the equipment or tool.
 b) The gauge (fig.3.2) indicates the pressure inside the main tank, NOT the pressure supplied to the air equipment. Should the pressure in the tank exceed the pre-set switch (6) maximum, the safety valve (5) will activate.

WARNING! for this reason DO NOT tamper with, or adjust, the switch or safety valve.

5. MAINTENANCE

In order to keep the compressor in good working condition, periodic maintenance is essential.

IMPORTANT! Failure to carry out maintenance tasks may invalidate the warranty on your compressor.

- WARNING! Before performing any maintenance operation, switch off compressor, disconnect from power supply and vent air from tank.**

- 5.1. **After the first 50 working hours.** Operations to be carried out:
 - a) Check that all bolts/nuts are tight, particularly those retaining the crank case and cylinder head (fig 4).
 - b) Replace the lubricating oil - see para 5.6.
- 5.2. **Daily.** Operation to be carried out :
 - a) Drain condensation by opening the drain valve (fig 5) located under the tank.
- 5.3. **Monthly (or more frequently, if the compressor operates in a very dusty atmosphere):**
 - a) Check oil level and, if necessary, top up. b) Remove the filter element (fig.6.X) by unscrewing wing nut and lowering the air filter cover. Clean by blowing through, with an air line at low pressure, from the clean side. Do not operate compressor without filter as foreign bodies or dust could damage the pump. c) Check belt tension. d) Check for oil leaks.
- 5.4. **3-monthly.** Operation to be carried out a) Check tank for internal corrosion.
- 5.5. **Every 500 hours.** Operations to be carried out :
 - a) Change air filter element
 - b) Check the automatic cut-out at max. pressure and the automatic cut-in at 2 bar below.
- 5.6. **Every 1000 hours.** Operations to be carried out :
 - a) Replace the lubricating oil. For oil specifications see 5.7.
 Remove the oil breather (fig 7.A) and screw (B), draining the oil into a container. Drain when the compressor is hot so that oil drains rapidly and completely. Wash breather in kerosene, fuel oil or similar. Replace screw 'B' and refill through the filler aperture. Do not overfill. Replace breather.
- WARNING! Never mix different oils and do not use non-detergent/low quality oils as compressor may be damaged.**
- WARNING! Dispose of waste oil only in accordance with local authority requirements.**
 - b) Check belt tension. A weight of 3kg applied at the belt mid-point should give a deflection of approx. 10mm (fig.8). If adjustment is required remember to maintain the alignment of the two pulleys (fig.8). Adjust by repositioning motor.
 - c) Check all tube fittings and electrical connections.
 - d) Inspect pressure tank inside and out for damage or corrosion.

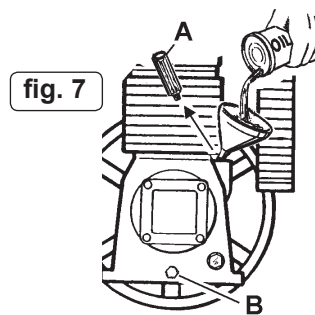
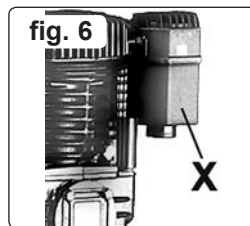
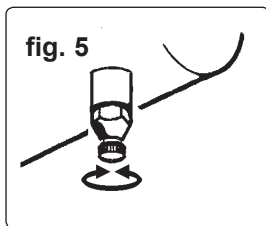
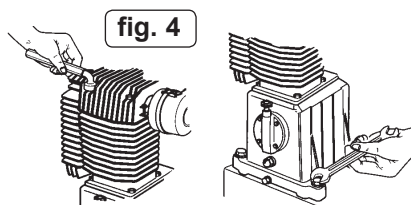

- 5.7. **Recommended oils**
 Recommended oil for compressors, suitable for room temperatures ranging from +5°C to +25°C:
 SEALEY CPO or equivalent SAE 40 compressor oil.

Room temperature below +50C: SAE 20 compressor oil.
 Approximate oil capacity: 1.4 litres.

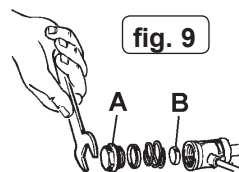
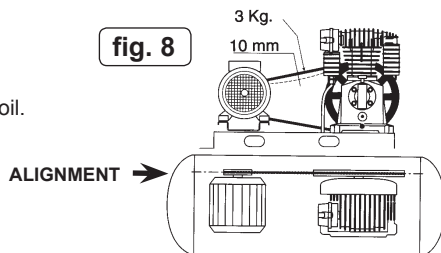

5.8. Scheduled maintenance tables

Maintenance Operations	Weekly	Monthly	3 Monthly
Drain condensation	●		
Check oil level		●	
Clean intake filter		●	
Check belt tension		●	
Check for oil leaks		●	
Check tank for internal corrosion			●

Maintenance Operations	500 hrs.	1000 hrs.
Replace air filter	●	
General cleaning of compressor	●	
Internal & external inspection of tank		●
Replace oil		●
Check tube fittings and electrical connections		●
Check condition of belt and pulleys		●

6. TROUBLE SHOOTING

Fault	Cause	Remedy
Pressure drop in the tank	Air leaks at connections	Run compressor to max. pressure, switch off. Brush soap solution over connections and look for bubbles. Tighten connections showing leaks. If problem persists contact Authorised Service Agent.
Pressure switch valve leaks when compressor is idle	Non-return valve seal defective	Empty the air tank, remove the non-return valve cap 'A' (fig 9) and clean and, if necessary, replace the seal 'B'.
Compressor stops and does not restart	Motor failure	Contact Authorised Service Agent.
Compressor does not stop at max. pressure	Pressure switch fault	Contact Authorised Service Agent.
Compressor does not reach max. pressure	Filter clogged Head gasket or valve fault	Replace filter element. Contact Authorised Service Agent.
Compressor speed fluctuates	Belt slipping	Adjust belt. See para. 5.6.b.
Compressor noisy with metallic knock	Bearing or piston damage	Contact Authorised Service Agent.

NOTE: It is our policy to continually improve products and as such we reserve the right to alter data, specifications and component parts without prior notice.

IMPORTANT: No liability is accepted for incorrect use of this product.

WARRANTY: Guarantee is 12 months from purchase date, proof of which will be required for any claim.

INFORMATION: For a copy of our latest catalogue and promotions call us on 01284 757525 and leave your full name and address, including postcode.



Sole UK Distributor, Sealey Group,
Kempson Way, Suffolk Business Park,
Bury St. Edmunds, Suffolk,
IP32 7AR



01284 757500



www.sealey.co.uk



01284 703534



sales@sealey.co.uk