

SEALEY

POWER PRODUCTS

INSTRUCTIONS FOR:
DIRECT DRIVE COMPRESSOR
MODEL NO: **SA2250/2**

Thank you for purchasing a Sealey product. Manufactured to a high standard this product will, if used according to these instructions and properly maintained, give you years of trouble free performance.



IMPORTANT: PLEASE READ THESE INSTRUCTIONS CAREFULLY. NOTE THE SAFE OPERATIONAL REQUIREMENTS, WARNINGS & CAUTIONS. USE THE PRODUCT CORRECTLY AND WITH CARE FOR THE PURPOSE FOR WHICH IT IS INTENDED. FAILURE TO DO SO MAY CAUSE DAMAGE OR PERSONAL INJURY AND WILL INVALIDATE THE WARRANTY. PLEASE KEEP INSTRUCTIONS SAFE FOR FUTURE USE.

1. SAFETY INSTRUCTIONS

1.1. ELECTRICAL SAFETY. ⚠ WARNING! It is the user's responsibility to read, understand and comply with the following: You must check all electrical equipment and appliances to ensure they are safe before using. You must inspect power supply leads, plugs and all electrical connections for wear or damage. You must ensure the risk of electric shock is minimised by the installation of appropriate safety devices. An RCCB (Residual Current Circuit Breaker) should be incorporated in the main distribution board. We also recommend that an RCD (Residual Current Device) is used with all electrical products. It is particularly important to use an RCD with portable products that are plugged into an electrical supply not protected by an RCCB. If in doubt consult a professional electrician. You may obtain a Residual Current Device by contacting your Sealey dealer. **You must** also read and understand the following instructions concerning electrical safety.

1.1.1. The **Electricity At Work Act 1989** requires all portable electrical appliances, if used on business premises, to be tested by a qualified electrician, at least once a year, using a Portable Appliance Tester (PAT).

1.1.2. The **Health & Safety at Work Act 1974** makes owners of electrical appliances responsible for the safe condition of those appliances, and the safety of appliance operators. **If in any doubt about electrical safety, contact a qualified electrician.**

1.1.3. Ensure the insulation on all cables and the product itself is safe before connecting to the mains power supply. See 1.1.1. & 1.1.2. above and use a Portable Appliance Tester (PAT).

1.1.4. Ensure that cables are always protected against short circuit and overload.

1.1.5. Regularly inspect power supply leads and plugs for wear or damage and connections to ensure that none is loose.

1.1.6. **Important:** Ensure the voltage marked on the product is the same as the electrical power supply to be used, and check that plugs are fitted with the correct capacity fuse. A 13Amp plug may require a fuse smaller than 13Amps for certain products (*subject to 1.1.10. below*) - see fuse rating at right.

1.1.7. **DO NOT** pull or carry the powered appliance by its power supply lead. Products such as welders must not be pulled or carried by their output cables.

1.1.8. **DO NOT** pull power plugs from sockets by the power cable.

1.1.9. **DO NOT** use worn or damage leads, plugs or connections. Immediately replace or have repaired by a qualified electrician. Where a U.K. 3 pin plug with ASTA/BS approval is fitted, in case of damage, cut off and fit a new plug according to the following instructions (discard old plug safely).

(UK only - see diagram at right). **Ensure the unit is correctly earthed via a three-pin plug.**

a) **Connect the GREEN/YELLOW earth wire to the earth terminal 'E'.**

b) **Connect the BROWN live wire to the live terminal 'L'.**

c) **Connect the BLUE neutral wire to the neutral terminal 'N'.**

After wiring, check there are no bare wires, that all wires have been correctly connected, that the cable outer insulation extends past the cable restraint and that the cable restraint is tight.

Double insulated products are often fitted with live (BROWN) and neutral (BLUE) wires only. Double insulated products are always marked with this symbol . **To re-wire, connect the brown & blue wires as indicated above. DO NOT connect the brown or blue wires to the earth terminal.**

1.1.10. **NOTE:** If this product requires more than a 13Amp electrical supply, then **NO** plug is fitted. **You must** therefore contact a qualified electrician to ensure a 30 amp fused supply is available. We recommend you discuss the installation of a industrial round pin plug & socket with your electrician.

1.1.11. **Cable extension reels.** When a cable extension reel is used it should be fully unwound before connection. A cable reel with an RCD fitted is recommended since any product which is plugged into the cable reel will be protected. The section of the cores in the cable is important and should be at least 1.5mm², but to be absolutely sure that the capacity of the cable reel is suitable for this product and for others that may be used in the other output sockets, we recommend the use of 2.5mm² section. **(Refer to Section 4.1)**

1.2. GENERAL SAFETY INSTRUCTIONS

Familiarise yourself with the application and limitations of the compressor.

Ensure the compressor is in good order and condition before use. If in any doubt do not use the unit and contact an electrician/service agent.

⚠ WARNING! Compressor must only be serviced by an authorised agent. DO NOT tamper with, or attempt to adjust, pressure switch or safety valve.

Before moving, or maintaining the compressor ensure it is unplugged from the mains supply and that the air tank pressure has been vented. Only use recommended attachments and parts. To use unapproved items may be dangerous and will invalidate your warranty.

Read the instructions regarding any accessory used with the compressor. Ensure the safe working pressure of any air appliance used exceeds unit's output pressure. If using spray gun, check that the area selected for spraying is provided with air change system/ventilation.

Ensure the air supply valve is turned off before disconnecting the air supply hose.

To move the compressor use the handle only. Lift the compressor so that the front leg gives enough clearance for manoeuvring but maintain unit's centre of gravity in front of the wheels. **DO NOT** attempt to lift or move the compressor by any means other than by the handle.

Use the compressor in a well ventilated area and ensure it is placed on a firm surface.

Keep tools and other items away from the compressor when it is in use, and keep area clean and clear of unnecessary items.

Ensure the air hose is not tangled, twisted or pinched.

Keep children and unauthorised persons away from the working area.

DO NOT dis-assemble compressor for any reason. The unit must be checked by qualified personnel only.

DO NOT use the compressor outdoors, or in damp, or wet, locations and **DO NOT** operate within the vicinity of flammable liquids, gases or solids.

DO NOT touch compressor cylinder, cylinder head or pipe from head to tank as these may be hot and will remain so for some time after shutdown.

DO NOT attempt to move the compressor by pulling the air tool hose. Only move the compressor by the handle.

DO NOT use this product to perform a task for which it is not designed.

DO NOT deface the certification plate attached to the compressor tank.

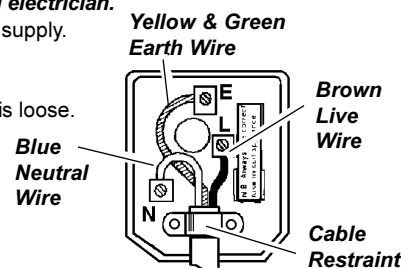

FUSE RATING
THE PLUG FITTED TO PRODUCT
MUST BE EQUIPPED WITH A
13 AMP FUSE

DO NOT cover the compressor or restrict air flow around the machine whilst operating.

▲ DANGER! DO NOT direct the output jet of air towards people or animals.

DO NOT operate the compressor without an air filter.

DO NOT allow anyone to operate the compressor unless they have received full instructions.

WARNING! The air tank is a pressure vessel and the following safety measures apply:

DO NOT tamper with the safety valve and DO NOT modify or alter the tank in any way and DO NOT strap anything to the tank. DO NOT subject the tank to impact, vibration or to heat and DO NOT allow contact with abrasives or corrosives.

DO drain condensation from tank daily and inspect inside walls for corrosion every three months and have a detailed tank inspection carried out annually.

The tank shell must not fall below the certified thickness at any point.

WARNING! If an electrical fuse blows, ensure it is replaced with an identical fuse type and rating.

When not in use, store the compressor carefully in a safe, dry, childproof location.

2. INTRODUCTION & SPECIFICATIONS

The SA2250/2 Direct Drive Compressor has an aluminium cylinder head with a cast iron cylinder giving added resistance to wear. It is suitable for general workshop applications. The pump head is directly coupled to a heavy duty induction motor for reliable and quiet operation. The welded tank complies with the latest safety requirements. The unit is fitted with a fully automatic pressure cut out switch with twin gauges displaying both tank and working pressures. Fitted with ASTA/BS approved non-rewirable plug.

2.1. Specification

Model No	SA2250/2
Motor Output	2.0hp
Voltage/Phase	230V - 1ph
Input Current	8.5A
Noise Level	82dB.A
Air Displacement	8.3cfm
Max Air Delivery	7.5cfm
Tank Capacity	50ltr
Max. Pressure	116psi/8bar

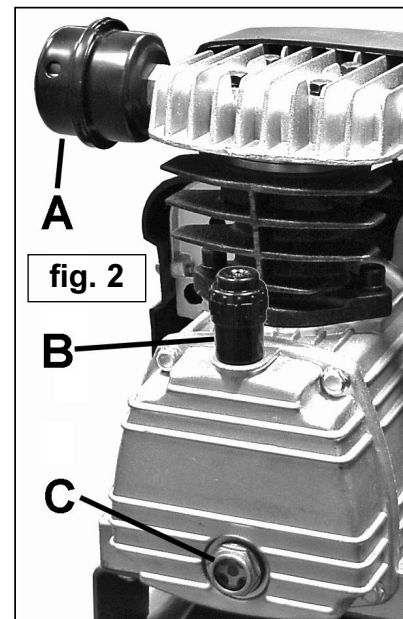
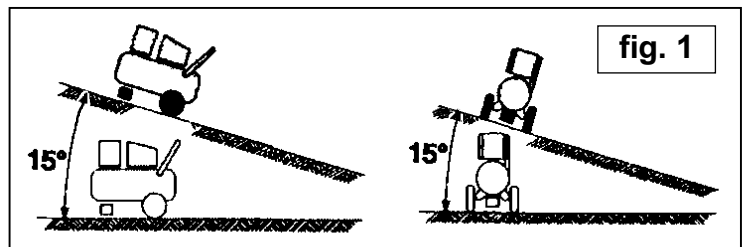

3. PREPARATION

- 3.1. Remove compressor from packaging and inspect for any shortages or damage. If anything is found to be missing or damaged contact your supplier.
- 3.2. Save the packing material for future transportation of the compressor. We recommend that you store the packing in a safe location, at least for the period of the guarantee. Then, if necessary, it will be easier to send the compressor to the service centre.
- 3.3. Confirm that the mains voltage corresponds with the voltage shown on the compressor data plate.
- 3.4. The compressor should be operated on a flat surface, or one that does not exceed 15° either transversely or longitudinally (fig.1), and should be in a position that allows good air circulation around the unit.

WARNING! The compressor is shipped without oil in the pump. Do not start the compressor until it has been filled with oil (see below).

- 3.5. Remove the plastic transit plug from the oil filler hole and pour in the recommended oil. (See section 5.6).
- 3.6. Before using the compressor check the oil level by referring to the oil sight glass (fig.2C). If the oil level is not up to the red centre mark it should be further topped up. Screw the filler/breather cap into the aperture as shown in fig.2B.

4. OPERATION

WARNING! Ensure that you have read, understood and apply Section 1 safety instructions.

- 4.1. **IMPORTANT.** The use of extension leads to connect this compressor to the mains is not recommended as the resulting voltage drop reduces motor, and therefore pump, performance.
- 4.2. Take care when selecting tools for use with the compressor. Air tool manufacturers normally express the volume of air required to operate a tool in cubic feet per minute (cfm). This refers to free air delivered by the compressor ('air out') which varies according to the pressure setting. Do not confuse this with the compressor displacement which is the air taken in by the compressor ('air in'). 'Air out' is always less than 'air in' - due to losses within the compressor .

4.3 STARTING THE COMPRESSOR.

- 4.3.1 Your compressor is fitted with a push/pull type of ON/OFF switch. To turn the compressor 'ON' pull the switch knob upwards. To turn the compressor 'OFF' push the knob downwards. (See fig.3-1)
- 4.3.2 Check that the ON/OFF switch is in the "OFF" position, the regulator tap (fig.3-3) is closed (Zero '0' bar), and tap (5) is OFF.
- 4.3.3 Plug mains lead into mains supply and start the compressor by pulling the switch knob upwards.
- 4.3.4 When starting the compressor for the first time, leave it running with air outlet (fig.3-5) closed and regulator (fig.3-3) set to maximum pressure. Make sure that pressure in the tank rises and that the compressor stops automatically when the max. pressure value allowed - written on the specification plate and shown on the gauge (fig.3-7) - is achieved. The compressor will now operate automatically. The pressure switch (fig.3-2) stops the motor when the maximum tank pressure is reached and restarts it when pressure falls below the minimum threshold - approx. 2 bar (29psi) less than the maximum pressure.
- 4.3.5 Stop the compressor by pushing the switch knob (See fig.3-1) downwards. The compressed air inside the compressor head will flow out, making the restart easier and preventing the motor from being damaged. **DO NOT**, other than in an emergency, stop the compressor by switching off the mains socket, or by pulling the plug out, as the pressure relief will not then occur and motor damage may result upon restart.

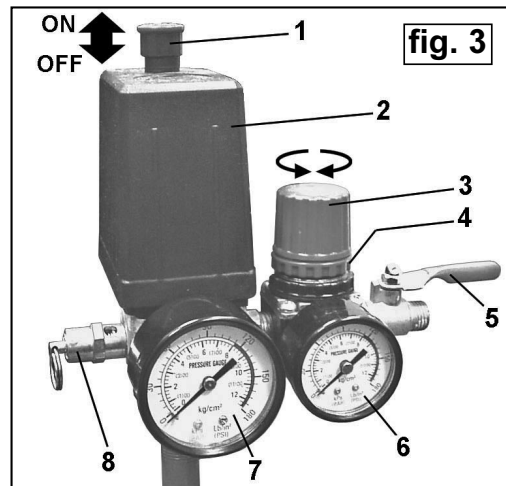

When the compressor runs correctly and is stopped correctly there will be:

- (a) a whistle of compressed air when the motor stops,
(b) a protracted whistle (about 20-25 seconds) when the compressor starts with no pressure in the tank.
- 4.3.6 The output pressure is regulated by the pressure regulator (fig.3-3). Turn the knob clockwise to increase pressure and anticlockwise to reduce it. The knob can be locked at any required setting by tightening the locking ring (fig.3-4) up against the underside of the knob. To determine the correct working pressure for any piece of equipment check the corresponding manual. When the compressor is not being used set the regulated pressure to zero so as to avoid damaging the pressure reducer.

- NOTE:** a) If the motor does not cut in and out, but runs continuously when using an air appliance, the capacity of the compressor may be too small for the equipment or tool.
b) The larger gauge (fig.3-7) indicates the pressure inside the main tank. The smaller gauge (fig.3-6) indicates the pressure supplied to the air equipment. Should the pressure in the main tank exceed the pre-set switch (fig.3-2) maximum, the safety valve (fig.3.8) will activate.

WARNING! For this reason DO NOT tamper with, or adjust, the switch or safety valve.

5. MAINTENANCE

In order to keep the compressor in good working condition, periodic maintenance is essential.

IMPORTANT! Failure to carry out maintenance tasks may invalidate the warranty on your compressor.

- WARNING! Before performing any maintenance operation, switch off the compressor, disconnect from electricity supply and release all air from the tank.**

- 5.1. Operations to be carried out **after the first 50 working hours:**
- Check that all bolts/nuts are tight, particularly those retaining the crank case and cylinder head.
 - Replace the lubricating oil - see para 5.4.
- 5.2. Operations to be carried out daily:
- Drain condensation by opening the valve located under the tank (fig.5). Place a container under the valve and open the valve by turning anticlockwise.
- 5.3. Operations to be carried out every 100 hours (or more frequently, if the compressor operates in a very dusty atmosphere):
- Check oil level and, if necessary, top up.
 - Remove the filter element (fig.4-B) and clean with compressed air. (Wear eye protection). Do not operate the compressor without the filter as foreign bodies or dust could seriously damage the pump.
 - Check for oil leaks
- 5.4. Operations to be carried out every 200 hours:
- Replace the lubricating oil. For oil specifications see 5.6.
Remove the oil filler/breather plug (see fig.2-B) then unscrew oil sight glass (see fig.2-C) and drain the oil into a container. Drain when the compressor is hot so that oil drains rapidly and completely. Incline compressor to ensure complete drainage. Replace oil sight glass and refill through the oil filler/breather aperture. Do not overfill. Replace filler/breather plug.
 - Check the automatic cut-out at max. pressure and the automatic cut-in at 2 bar below.

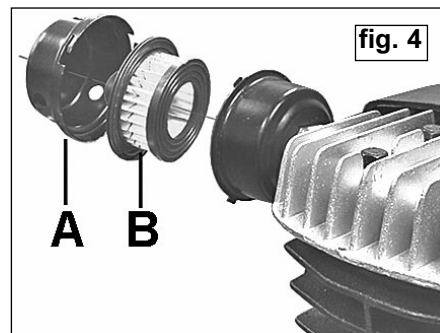

- WARNING! Never mix different oils and do not use non-detergent/low quality oils as the compressor may be damaged.**
- WARNING! Dispose of waste oil only in accordance with local authority requirements.**

- 5.5. Operations to be carried out every 500 hours:
- Replace air filter. (See fig4.B)
 - Check all tube fittings and electrical connections.
 - Inspect pressure tank inside and out for damage or corrosion.
- 5.6. Recommended oils
Recommended oil for compressors, suitable for room temperatures ranging from +5°C to +25°C.
SEALEY CPO or equivalent SAE 40 compressor oil.
Room temperature below +5°C: SAE 20 compressor oil.
Approximate oil capacity: 0.16 litres.

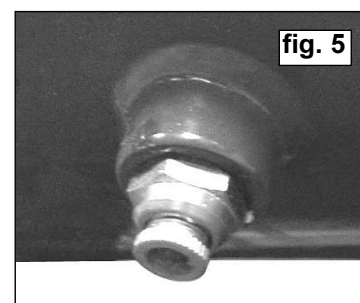

5.6. Scheduled maintenance table

Maintenance Operations	Daily	100 hrs.	200 hrs.	500 hrs.
Drain condensation	•			
Check oil level		•		
Clean intake filter		•		
Check for oil leaks		•		
Check cut-out			•	
Replace oil			•	
General cleaning of compressor			•	
Internal & external inspection of tank				•
Replace air filter				•
Check tube fittings and electrical connections				•

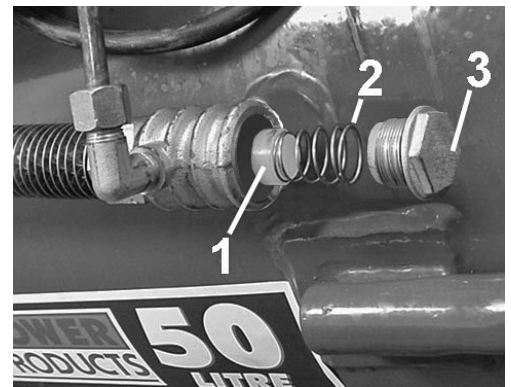

fig. 6

6. TROUBLE SHOOTING

Fault	Cause	Remedy
Pressure drop in the tank	Air leaks at connections	Run compressor to max. pressure, switch off. Brush soap solution over connections and look for bubbles. Tighten connections showing leaks. If problem persists contact Authorised Service Agent.
Pressure switch valve leaks when compressor is idle	Non-return valve seal defective	Empty the air tank, remove the non-return valve cap '3' (fig.6) and clean, or if necessary replace, the seal '1'.
Compressor stops and does not restart	Motor failure	Contact Authorised Service Agent.
Compressor does not stop at max. pressure	Pressure switch fault	Contact Authorised Service Agent.
Compressor does not stop at max. pressure	Filter clogged Head gasket or valve fault	Replace filter element. Contact Authorised Service Agent.
Compressor noisy with metallic knock	Bearing or piston damage	Contact Authorised Service Agent.

Declaration of Conformity We, the sole UK importer, declare that the product listed below is in conformity with the following standards and directives.

DIRECT DRIVE COMPRESSOR
Models: SA2250/2
 87/404/EEC Pressure Vessel Directive
 89/336/EEC EMC Directive
 73/23/EEC LV Directive
 98/37/EC Machinery Directive

The construction file for this product is held by the Manufacturer and may be inspected, by a national authority, upon request to Jack Sealey Ltd.

Signed by Mark Sweetman 2nd July 2004

For Jack Sealey Ltd. Sole UK importer of Sealey Power Products.

NOTE: It is our policy to continually improve products and as such we reserve the right to alter data, specifications and component parts without prior notice.

IMPORTANT: No liability is accepted for incorrect use of this equipment.

WARRANTY: Guarantee is 12 months from purchase date, proof of which will be required for any claim.

INFORMATION: For a copy of our latest catalogue and promotions call us on 01284 757525 and leave your full name and address, including postcode.

	Sole UK Distributor Sealey Group, Bury St. Edmunds, Suffolk.	01284 757500 01284 703534	www.sealey.co.uk sales@sealey.co.uk
--	--	------------------------------	--