

Thank you for purchasing a Sealey product. Manufactured to a high standard this product will, if used according to these instructions and properly maintained, give you years of trouble free performance.



IMPORTANT: PLEASE READ THESE INSTRUCTIONS CAREFULLY. NOTE THE SAFE OPERATIONAL REQUIREMENTS, WARNINGS AND CAUTIONS. USE THE PRODUCT CORRECTLY AND WITH CARE FOR THE PURPOSE FOR WHICH IT IS INTENDED. FAILURE TO DO SO MAY CAUSE DAMAGE OR PERSONAL INJURY AND WILL INVALIDATE THE WARRANTY. PLEASE KEEP INSTRUCTIONS SAFE FOR FUTURE USE.

1. SAFETY INSTRUCTIONS

1.1. ELECTRICAL SAFETY. **WARNING!** *It is the user's responsibility to read, understand and comply with the following:*

You must check all electrical equipment and appliances to ensure they are safe before using. You must inspect power supply leads, plugs and all electrical connections for wear or damage. You must ensure the risk of electric shock is minimised by the installation of appropriate safety devices. An RCCB (Residual Current Circuit Breaker) should be incorporated in the main distribution board. We also recommend that an RCD (Residual Current Device) is used with all electrical products. It is particularly important to use an RCD with portable products that are plugged into an electrical supply not protected by an RCCB. If in doubt consult a professional electrician. You may obtain a Residual Current Device by contacting your Sealey dealer. **You must** also read and understand the following instructions concerning electrical safety.

- 1.1.1. The **Electricity At Work Act 1989** requires all portable electrical appliances, if used on business premises, to be tested by a qualified electrician, at least once a year, using a Portable Appliance Tester (PAT).
- 1.1.2. The **Health & Safety at Work Act 1974** makes owners of electrical appliances responsible for the safe condition of those appliances, and the safety of appliance operators. **If in any doubt about electrical safety, contact a qualified electrician.**
- 1.1.3. Ensure the insulation on all cables and the product itself is safe before connecting to the mains power supply.
See 1.1.1. & 1.1.2. above and use a Portable Appliance Tester (PAT).
- 1.1.4. Ensure that cables are always protected against short circuit and overload.
- 1.1.5. Regularly inspect power supply leads and plugs for wear or damage and connections to ensure that none is loose.
- 1.1.6. **Important:** Ensure the voltage marked on the product is the same as the electrical power supply to be used, and check that plugs are fitted with the correct capacity fuse.
- 1.1.7. DO NOT pull or carry the powered appliance by its power supply lead.
- 1.1.8. DO NOT pull power plugs from sockets by the power cable.
- 1.1.9. DO NOT use worn or damage leads, plugs or connections. Immediately replace or have repaired by a qualified electrician.

1.1.10. **NOTE: THIS PRODUCT IS INTENDED FOR USE ON AN INDUSTRIAL 30AMP SUPPLY WHICH MUST BE INSTALLED BY A QUALIFIED ELECTRICIAN.** It may be possible to operate the compressor on a "Domestic" 13Amp outlet under the following conditions: The mains supply must conform to IEE Wiring Regulations, and the "spur" used to run the compressor must not include any other socket which could be used for another appliance. The distance of the socket from the mains distribution point must not exceed 5 metres.

An extension lead must not be used.

- 1.1.11. **Note:** Under certain conditions your compressor will draw more than 13Amps. Consequently, we recommend a 30Amp supply and suggest that a direct round pin plug/socket is installed by a qualified electrician. In the event that you choose to use a domestic 13Amp supply, we provide the plug wiring instructions as follows:
(UK only - see diagram at right). Ensure the unit is correctly earthed via a three-pin plug.

- a) Connect the green/yellow earth wire to the earth terminal 'E'.
- b) Connect the brown live wire to the live terminal 'L'.
- c) Connect the blue neutral wire to the neutral terminal 'N'.

Ensure the plug is fitted with a 13Amp fuse.

After wiring, check there are no bare wires, that all wires have been correctly connected, that the cable outer insulation extends past the cable restraint and that the cable restraint is tight.

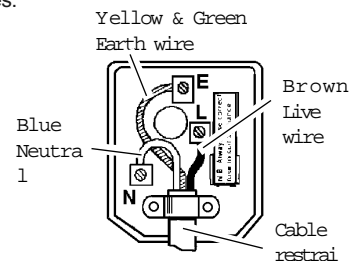

NOTE: IF USED ON A DOMESTIC 13AMP SUPPLY AND THE FUSE REPEATEDLY BLOWS, CONTACT A QUALIFIED ELECTRICIAN TO INSTALL A 30AMP SUPPLY.

1.2. GENERAL SAFETY INSTRUCTIONS

Familiarise yourself with the application and limitations of the compressor.

Ensure the compressor is in good order and condition before use. If in any doubt do not use the unit and contact an electrician/service agent.

WARNING! Compressor must only be serviced by an authorised agent. DO NOT tamper with, or attempt to adjust, pressure switch or safety valve.

Before moving, or maintaining the compressor ensure it is unplugged from the mains supply and that the air tank pressure has been vented.

Only use recommended attachments and parts. To use non-recommended items may be dangerous and will invalidate your warranty.

Read the instructions regarding any accessory used with the compressor. Ensure the safe working pressure of any air appliance used exceeds the compressors output pressure. If using a spray gun, check the area selected for spraying is provided with air change system/ventilation.

Ensure the air supply valve is turned off before disconnecting the air supply hose.

To move the compressor use the handle only. Lift the compressor so that the front leg gives enough clearance for manoeuvring but maintain unit's centre of gravity in front of the wheels. DO NOT attempt to lift or move the compressor by any means other than by handle.

Use the compressor in a well ventilated area and ensure it is placed on a firm surface.

Keep tools and other items away from the compressor when it is in use and keep area clean and clear of unnecessary items.

Ensure the air hose is not tangled, twisted or pinched.

Keep children and unauthorised persons away from the working area.

DO NOT dis-assemble compressor for any reason. The unit must be checked by qualified personnel only.

DO NOT use the compressor outdoors, or in damp, or wet, locations and DO NOT operate within the vicinity of flammable liquids, gases or solids.

DO NOT touch compressor cylinder, cylinder head or pipe from head to tank as these may be hot and will remain so for some time after shutdown.

DO NOT attempt to move the compressor by pulling the air tool hose. Only move the compressor by its handle.

DO NOT use this product to perform a task for which it has not been designed.

DO NOT deface the certification plate attached to the end of the compressor tank.

DO NOT cover the compressor or restrict air flow around the machine whilst operating.

s **DANGER! DO NOT direct the output jet of air towards people or animals.**

DO NOT operate the compressor without an inlet air filter (see figure 2).

DO NOT allow anyone to operate the compressor unless they have received full instructions. p **WARNING! The air tank is a pressure vessel and the following safety measures apply:**

DO NOT tamper with the safety valve and DO NOT modify or alter the tank in any way and DO NOT strap anything to the tank.

DO NOT subject the tank to impact, vibration or to heat and DO NOT allow contact with abrasives or corrosives.

DO drain condensation from tank daily, inspect inside walls for corrosion every three months and have a detailed tank inspection carried out annually.

The tank shell must not fall below the certified thickness at any point.

p **WARNING! If an electrical fuse blows, ensure it is replaced with an identical fuse type and rating (See part 1.1.11).**

When not in use, store the compressor carefully in a safe, dry, childproof location.

2. INTRODUCTION & SPECIFICATIONS

The SA2110/3, SA2115/3 and SA2120/3 Premier Line Compressors have twin cylinder pumps belt driven by 230V 1ph motors and are capable of supplying air at up to 10 bar from 100 to 200 litre tanks. In addition to pneumatic tools, the compressors may be connected to accessories suitable for blowing, washing, spraying and tyre inflation. SA2110/3 has two rear wheels, a castor front wheel and a handle for ease of movement.

2.1. Specifications

Model	Max Motor Output (hp)	Voltage/Phase	Current (A)	Pump Type	Pump Speed (rpm)	Piston Displacement (cfm)	Free Air Delivery (cfm)			Tank Capacity (l)	Max. Pressure (psi/bar)	Noise Level (dB.A)
							Max.	At 2.5 Bar*	At 6.0 Bar*			
SA2110/3	3	230/1	13	K17	1180	14.9	12.0	11.6	10.6	100	145/10	73
SA2115/3	3	230/1	13	K17	1180	14.9	12.0	11.6	10.6	150	145/10	74
SA2120/3	3	230/1	13	K17	1180	14.9	12.0	11.6	10.6	200	145/10	74

All performance figures are ± 5%

2.2. Weights & Dimensions

Model	Weight (kg)	Dimensions Length x Width x Height (mm)
SA2110/3	78	1140 x 420 x 890
SA2115/3	82	1280 x 410 x 880
SA2120/3	94	1410 x 470 x 920

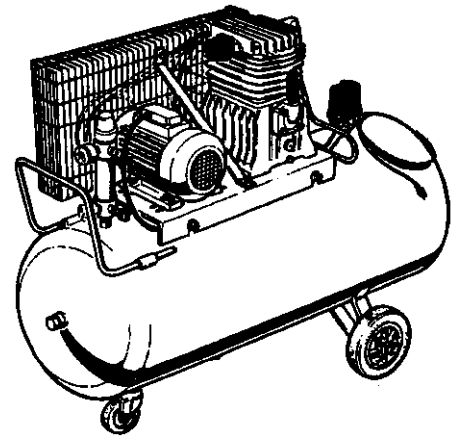

3. PREPARATION

- Remove compressor from packaging and inspect for any shortages or damage. If anything is found to be missing or damaged contact your supplier.
- Save the packing material for future transportation of the compressor. We recommend that you store the packing in a safe location, at least for the period of the guarantee. Then, if necessary, it will be easier to send the compressor to the service centre.
- Confirm that the mains voltage corresponds with the voltage shown on the compressor data plate.
- The compressor should be operated on a flat surface, or one that does not exceed 15° either transversely or longitudinally (fig.1), and should be in a position that allows good air circulation around the unit.
- Fit the air filter (fig.2) to the inlet port of the cylinder head. SA2110/3 - Screw the stud provided into the tapped hole at the rear of the port and mount circular filter 'A' with wing nut. SA2115/3 and SA2120/3 - Attach filter 'B' with the two bolts and gasket provided.
- Confirm that the oil level is at the maximum mark on the sight glass (fig.3).

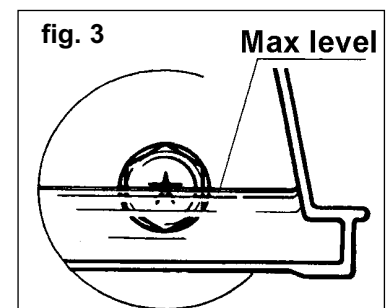
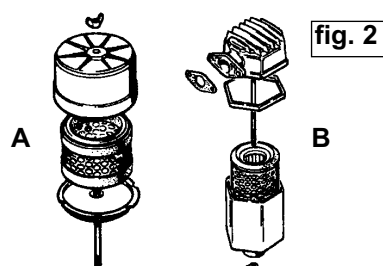
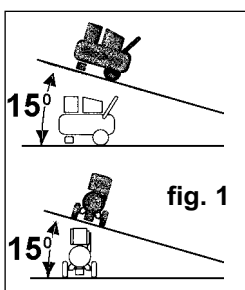

4. OPERATION

After completing the preparation the compressor is ready to operate.

IMPORTANT

- The motors on these compressors are 3HP/230V and at normal mains voltage will start within the capacity of a 13 amp fused circuit. Certain local conditions relating to electrical supply in the UK can result in the voltage varying between a low of 216 volts and a high of 253 volts. At such times of fluctuating voltage the 13 amp fuse in the compressor plug may blow. This is normal and is not a fault with the compressor. However if it happens regularly we recommend that you consult an electrician with a view to installing a 30 amp supply, with contact breaker, to avoid the inconvenience of frequent fuse replacement.

WARNING! Extension lead **MUST NOT** be used to connect compressor to the mains as the resulting voltage drop would reduce motor output, and pump performance causing the 13Amp fuse to blow.

- Take care when selecting tools for use with the compressor. Air tool manufacturers normally express the volume of air required to operate a tool in cubic feet per minute (cfm). This refers to free air delivered by the compressor ('air out') which varies according to the pressure setting. Do not confuse this with the compressor displacement which is the air taken in by the compressor ('air in'). 'Air out' is always less than 'air in' - due to losses within the compressor - and so it is important that, before choosing equipment, you study the 'Free Air Delivery' figures shown in the Specification chart, section 2.

WARNING! Ensure that you have read, understood and apply section 1 safety instructions.

- Make sure the main switch (fig.4.'A') is in position "O", off.
- Plug the mains lead into mains supply and start the compressor by turning the main switch to "I", on.
- When starting compressor for the first time, leave it running with air outlet closed and reducer (fig.5.'A') set to maximum. Make sure that pressure in tank rises and that compressor stops automatically when max. pressure value allowed - written on plate and shown on gauge (fig.4) - is achieved.

Note: SA2115/3 and SA2120/3 are not supplied with an integral pressure regulator.

The compressor will now operate automatically. The pressure switch stops the motor when the maximum tank pressure is reached and restarts it when pressure falls below the minimum threshold - approx. 2 bar (29psi) less than the maximum pressure.

- Stop the compressor by turning the main switch off (fig.4). The compressed air inside the compressor head will flow out, making the restart easier and preventing the motor from being damaged. **DO NOT**, other than in an emergency, stop the compressor by switching off the mains socket, or by pulling the plug out, as the pressure relief will not then occur and motor damage may result upon restart.

When the compressor runs correctly and is stopped correctly there will be:

- a whistle of compressed air when the motor stops,
- a protracted whistle (about 20-25 seconds) when the compressor starts with no pressure in the tank.

- The compressor is equipped with an overload cut-out to protect the motor. The manual reset 'D' (fig.6) should not be operated until 3 minutes after cut-out, to allow the motor to cool. To restart, turn main switch off, reset 'D' and then turn main switch on. If, after restarting, the compressor again automatically cuts out turn off at the main switch and contact Service Agent.

- SA2110/3 - The output pressure is regulated by the pressure reducer (fig.5.'A'). Lift and turn the knob clockwise to increase pressure and anticlockwise to reduce it - push knob down to lock in required position. The gauge (fig.5) will show the output pressure. To determine the correct working pressure for any piece of equipment check the corresponding manual.

When the compressor is not being used set the regulated pressure to zero so as to avoid damaging the pressure reducer.

NOTE: a) If the motor does not cut in and out, but runs continuously when using an air tool, the capacity of the compressor may be too small.

b) The gauge 'B' (fig.4) indicates the pressure inside the main tank, NOT the pressure supplied to the air equipment. Should the pressure in the main tank exceed the pre-set switch 'C' maximum, a safety valve 'D' will activate. **WARNING! for this reason DO NOT tamper with or adjust the switch or safety valve.**

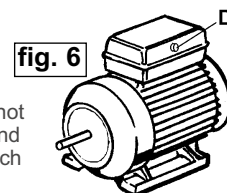
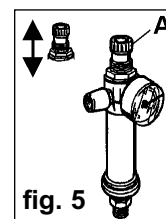
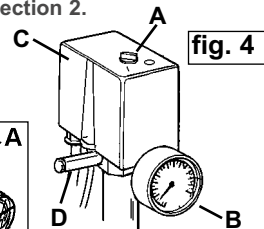

5. MAINTENANCE

In order to keep the compressor in good working condition, periodic maintenance is essential.

IMPORTANT! Failure to carry out maintenance tasks may invalidate the warranty on your compressor.

WARNING! Before performing any maintenance operation, switch off compressor, disconnect from power supply and vent air from tank.

- Operations to be carried out **after the first 50 working hours**:
 - Check that all bolts/nuts are tight, particularly those retaining the crank case and cylinder head.
 - Replace the lubricating oil - see para 5.6.
- Operation to be carried out daily:
 - Drain condensation by opening the valve 'C' located under the tank.
- Operations to be carried out monthly (or more frequently, if the compressor operates in a very dusty atmosphere):
 - Check oil level and, if necessary, top up.
 - Remove the filter element (fig.2) and clean by blowing through, with an air line at low pressure, from the clean side. Do not operate compressor without filter as foreign bodies or dust could damage the pump.
 - Check belt tension
 - Check for oil leaks
- Operation to be carried out 3-monthly:
 - Check tank for internal corrosion.
- Operations to be carried out every 500 hours:
 - Change air filter element
 - Check the automatic cut-out at max. pressure and the automatic cut-in at 2 bar below.
- Operations to be carried out every 1000 hours:
 - Replace the lubricating oil. For oil specifications see 5.8.
Remove the oil breather 'A' and screw 'B', draining the oil into a container. Drain when the compressor is hot so that oil drains rapidly and completely.
Replace screw 'B' and refill through the filler aperture. Do not overfill. Replace breather.

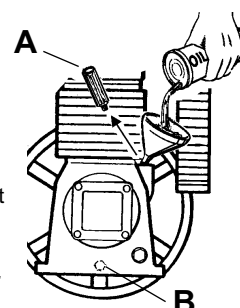
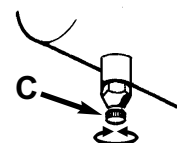
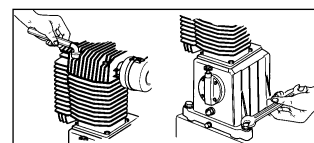

WARNING! Never mix different oils and do not use non-detergent/low quality oils as the compressor may be damaged.

WARNING! Dispose of waste oil only in accordance with local authority requirements.

- b) Check belt tension. A weight of 3kg applied at the belt mid-point should give a deflection of approx. 10mm (fig.7). If adjustment is required remember to maintain the alignment of the two pulleys (fig.7). Adjust by repositioning motor.
- c) Check all tube fittings and electrical connections.
- d) Inspect pressure tank inside and out for damage or corrosion.

5.7. Scheduled maintenance table

Maintenance Operations	Daily	Monthly	3 Monthly	500 hrs.	1000 hrs.
Drain condensation	●				
Check oil level		●			
Clean intake filter		●			
Check belt tension		●			
Check for oil leaks		●			
Check tank for internal corrosion			●		
Replace air filter				●	
General cleaning of compressor				●	
Internal & external inspection of tank					●
Replace oil					●
Check tube fittings and electrical connections					●
Check condition of belt and pulleys					●

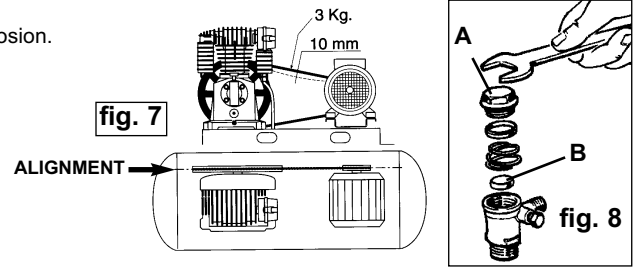

- 5.8. Recommended oils
 Recommended oil for compressors, suitable for room temperatures ranging from +5°C to +25°C.
 SEALEY CPO or equivalent SAE 40 compressor oil.
 Room temperature below +5°C: SAE 20 compressor oil.
 Approximate oil capacity: 1.0 litre.

6. TROUBLE SHOOTING

Fault	Cause	Remedy
Pressure drop in the tank	Air leaks at connections	Run compressor to max. pressure, switch off. Brush soap solution over connections and look for bubbles. Tighten connections showing leaks. If problem persists contact Authorised Service Agent.
Pressure switch valve leaks when compressor is idle	Non-return valve seal defective	Empty the air tank, remove the non-return valve cap 'A' (fig.8) and clean the seat 'B'. If necessary replace the seal.
Compressor stops and does not restart	Overload cut-out operated - motor overheating	Press the button 'D' to restart (fig.6).
Compressor stops and does not restart	Motor failure	Contact Authorised Service Agent.
Compressor does not stop at max. pressure	Pressure switch fault	Contact Authorised Service Agent.
Compressor does not stop at max. pressure	Filter clogged Head gasket or valve fault	Replace filter element. Contact Authorised Service Agent.
Compressor speed fluctuates	Belt slipping	Adjust belt. See para. 5.6.b.
Compressor noisy with metallic knock	Bearing or piston damage	Contact Authorised Service Agent.

Declaration of Conformity We, the sole UK importer, declare that the products listed below are in conformity with the following standards and directives.

PREMIER LINE COMPRESSORS

Models: SA2110/3, SA2115/3 & SA2120/3

87/404/EEC Pressure Vessel Directive
 89/336/EEC EMC Directive
 73/23/EEC LV Directive
 98/37/EC Machinery Directive



The construction files for these products are held by the Manufacturer and may be inspected on request by contacting Jack Sealey Ltd.

Signed by Mark Sweetman

1st September 1999

For Jack Sealey Ltd. Sole UK importer of Sealey Power Products

NOTE: It is our policy to continually improve products and as such we reserve the right to alter data, specifications and component parts without prior notice.

IMPORTANT: No liability is accepted for incorrect use of this equipment

WARRANTY: Guarantee is 12 months from purchase date, proof of which will be required for any claim.

INFORMATION: For a copy of our latest catalogue call us on 01284 757525 and leave your full name and address, including postcode.



Sole UK Distributor
Sealey Group,
 Bury St. Edmunds, Suffolk.



01284 757500



01284 703534

E-mail: sales@sealey.co.uk