



GENERAL-PURPOSE GRAVITY FEED SPRAY GUNS - 1.4MM & 1.8MM

MODEL NO: **S641G & S642G**

Thank you for purchasing a Sealey product. Manufactured to a high standard, this product will, if used according to these instructions, and properly maintained, give you years of trouble free performance.

IMPORTANT: PLEASE READ THESE INSTRUCTIONS CAREFULLY. NOTE THE SAFE OPERATIONAL REQUIREMENTS, WARNINGS & CAUTIONS. USE THE PRODUCT CORRECTLY AND WITH CARE FOR THE PURPOSE FOR WHICH IT IS INTENDED. FAILURE TO DO SO MAY CAUSE DAMAGE AND/OR PERSONAL INJURY AND WILL INVALIDATE THE WARRANTY. KEEP THESE INSTRUCTIONS SAFE FOR FUTURE USE.



Refer to instructions



Wear eye protection



Wear protective gloves



Wear safety footwear



Wear protective clothing



Wear a mask

1. SAFETY

- WARNING!** Disconnect the spray gun from the air supply before changing accessories, servicing or performing any maintenance.
- ✓ Familiarise yourself with this products application and limitations, as well as the specific potential hazards peculiar to the spray gun. Paint cup remains pressurised after gun is disconnected from air line.
- ✗ **DO NOT** pull the trigger, but release the pressure by gently opening cup.
- ✓ Maintain the spray gun in good condition (use an authorised service agent).
- ✓ Replace or repair damaged parts. Use recommended parts only. Non authorised parts may be dangerous and will invalidate the warranty.
- ✓ Locate the spray gun in an adequate working area for its function, keep area clean and tidy and free from unrelated materials, and ensure there is adequate ventilation and lighting.
- ✓ Keep the spray gun clean for best and safest performance.
- ✓ Ensure the air system is suitable to the spray gun air consumption, (see specifications).
- ✓ Wear approved respiratory protection and safety eye goggles.
- ✓ Remove ill fitting clothing. Remove ties, watches, rings, and other loose jewellery, and tie back long hair.
- ✓ Keep children and unauthorised persons away from the working area.
- ✓ Avoid unintentional operation.
- ✗ **DO NOT** point spray gun at yourself, at other persons or animals.
- ✗ **DO NOT** carry the by the air hose, or pull the hose from the air supply.
- ✗ **DO NOT** use the spray gun for any purpose other than for which it is designed.
- ✗ **DO NOT** allow untrained persons to operate the spray gun.
- ✗ **DO NOT** get the spray gun wet or use in damp or wet locations or areas where there is condensation.
- ✗ **DO NOT** operate gun if any parts are missing or damaged as this may cause failure or personal injury.
- ✗ **DO NOT** direct air from the air hose at yourself or others.
- ✓ When not in use switch the spray gun off, and disconnect from the air supply.

2. INTRODUCTION

Standard set-up and economy price make this spray gun ideal for applying various materials including adhesives, base coats and finishing coats. Round/flat fan control allows spray pattern to be adjusted for any job. Brass air cap with steel needle and nozzle. Alternative set-ups available separately.

3. SPECIFICATION

Model No.....	S641G.....	S642G
Air Consumption.....	4-8cfm.....	4-8cfm
Available Set-Ups.....	1.7, 1.8, 2.0mm.....	1.4, 1.7, 2.0mm
Pot Capacity.....	600ml.....	600ml
Recommended air Pressure.....	45psi.....	45psi
Standard Set-Up.....	1.4mm.....	1.8mm

4. AIR SUPPLY

- 4.1. Recommended hook-up fig.1
- 4.1.1. Ensure spray gun air valve (or trigger) is in the off position before connecting to the air supply.
- 4.1.2. You will require an air pressure of 45psi, and an air flow according to specification.
 - WARNING!** Ensure the air supply is clean and does not exceed 45psi while operating the spray gun. Too high an air pressure and/or unclean air will shorten the product life due to excessive wear, and may be dangerous causing damage and/or personal injury.
- 4.1.3. Drain the air tank daily. Water in the air line will ruin the paint finish and damage the spray gun.
- 4.1.4. Clean air inlet filter weekly.
- 4.1.5. Line pressure should be increased to compensate for unusually long air hoses (over 8 metres). The minimum hose diameter should be 1/4" I.D. and fittings must have the same inside dimensions.
- 4.1.6. Keep hose away from heat, oil and sharp edges. Check hose for wear, and make certain that all connections are secure.

4.2. COUPLINGS

Vibration may cause failure if a quick change coupling is connected directly to the spray gun. To overcome this, connect a leader hose to the spray gun. A quick change coupling may then be used to connect the leader hose to the air line recoil hose (fig.1 and 2).

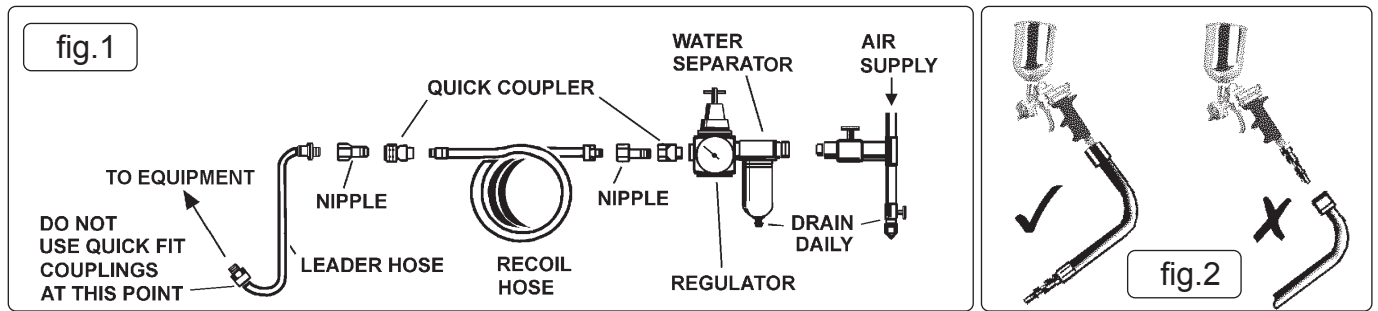

5. OPERATION

- 5.1. For best results, the gun should be held perpendicular to the surface being sprayed and moved parallel to it. Start the stroke before squeezing the trigger and release the trigger before finishing the stroke. This will enable accurate control of the gun and material (fig.3B).
- 5.2. Spray from a distance of about 6 to 10 inches (150 to 250mm) depending on the material and the atomizing pressure. The material deposited should always be even and wet. Each stroke must overlap the preceding stroke to obtain a uniform finish. To reduce over-spray and obtain maximum efficiency, spray with the lowest possible atomizing air pressure.
- 5.3. Controlling the fan spray and the fluid.
 - a) Use the needle (paint) adjustment knob (fig.4.2) to adjust the amount of paint flow.
 - b) The atomizing air flow is controlled by the control knob (fig.4.1).
 - c) The volume of air input is controlled by the adjustment knob (fig.4.3).
 - d) As width of spray is increased more material must pass through the gun to obtain the same coverage on the increased area.
 - e) Turn the air nozzle (fig.4.4) to achieve a horizontal or vertical fan spray. Lock the nozzle with retaining ring (fig.4.5). The spray pattern of the gun is variable from round to flat with all patterns in between. In normal operation, the wings on the nozzle are horizontal (fig.5). This provides a vertical fan-shaped pattern which gives maximum, uniform and even coverage when moving the gun back and forth, parallel to the work surface (fig.6).

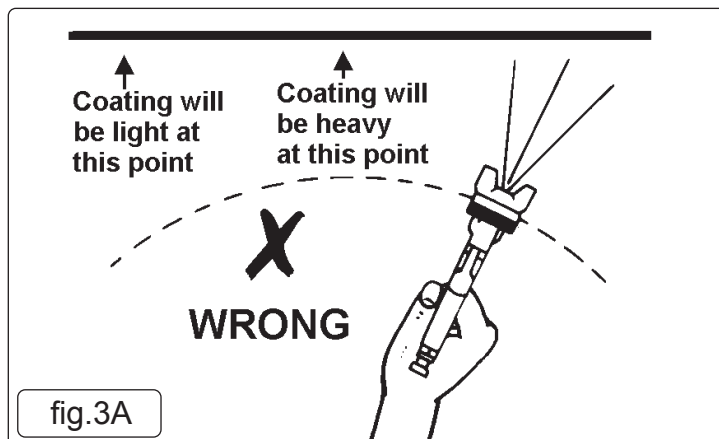

fig.3A

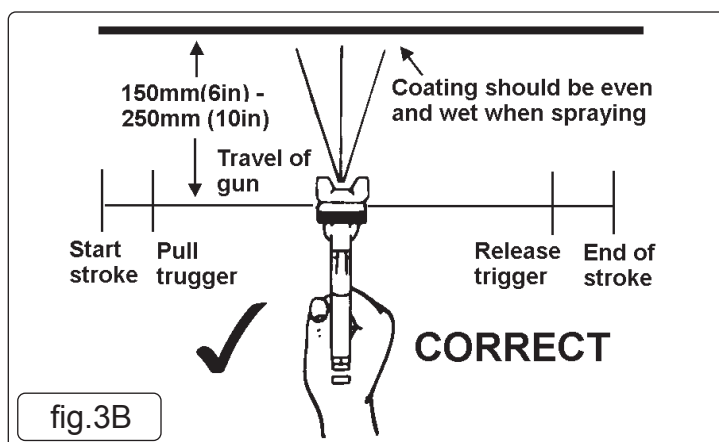

fig.3B

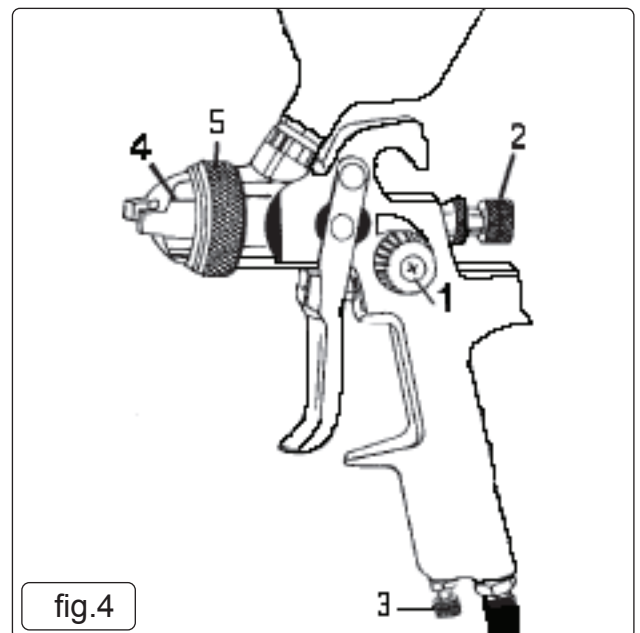

fig.4

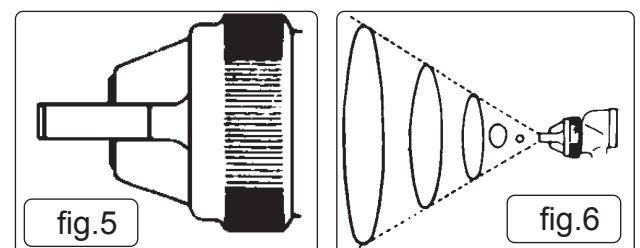

fig.5

fig.6

6. CLEANING/MAINTENANCE

FOR OPTIMUM PERFORMANCE IT IS VERY IMPORTANT TO ENSURE THE SPRAY GUN IS CORRECTLY CLEANED AFTER EACH USE.

Disconnect from the air supply before attempting any cleaning or maintenance.

6.1. CLEANING THE GUN





- 6.1.1. Flush the gun through with clean solvent.
- 6.1.2. Use a bristle brush and solvent to wash off accumulated paint.
- 6.1.3. Clean the air nozzle using a brush. Blow clean with air. Handle all nozzles carefully and do not make any alterations in the gun.
- 6.1.4. Wipe the outside of the gun with a dampened solvent rag.
- 6.1.5. If there is a need to probe the holes in the nozzles, ensure a tool that is softer than brass is utilised, under no circumstances use a metal tool, as the slightest amount of damage will adversely affect the spray pattern.
- 6.1.6. Adjust the fluid needle valve so that when the gun is triggered, air flow occurs before fluid flow.

6.2. MAINTENANCE

- 6.2.1. Take care when re-assembling. Screw parts hand tight to avoid cross-threading. If a part cannot easily be turned by hand, check that it is the correct part, or unscrew it, realign and retry. **DO NOT** use excessive force when re-assembling.
- 6.2.2. When changing the nozzle size, ensure the complete nozzle set is fitted. This consists of air cap, fluid nozzle and paint needle. Insert the fluid nozzle before paint needle.

7. TROUBLESHOOTING

A faulty spray is usually caused by improper cleaning or dried material around the fluid nozzle tip or in the air nozzle. If cleaning is required, remove these parts and soak them in solvent. This will soften the dried material which can then be removed with a brush or a cloth. These parts are carefully machined and any damage to them will cause a faulty spray. If either the air nozzle or fluid nozzle are damaged, they must be replaced before a perfect spray can be obtained.

Problem	Possible Cause	Solution
	Dried material in a side port restricts passage of air. Greater flow of air from the clean side port forces a fan pattern in the direction of the clogged side.	Dissolve material in the side ports with solvent, then blow the gun clean. Do not poke into the nozzles with metal instruments.
	Dried material around the outside of the fluid nozzle tip restricts the passage of atomizing air at one point through the centre opening of the air nozzle and results in the pattern shown. This pattern can also be caused by a loose air nozzle.	Remove the air nozzle and wipe off fluid tip using a rag dampened with solvent. Tighten the air nozzle.
	Material too thin or atomization air pressure too high.	Regulate material viscosity or reduce air pressure.
 Paint spray 'flutters'	Not enough paint in bottle. Nozzle set / seating dirty, damaged or loosely installed.	Refill bottle. Remove the fluid nozzle, clean the back of the nozzle and the nozzle seat using a cloth dampened with thinner. Refit the nozzle and secure it tightly against the body. If necessary replace nozzle set.
Material bubbles or "boils" in paint cup.	Atomised air flowing through the paint channel to the bottle. The paint nozzle is not sufficiently tight. Air nozzle is not completely screwed on.	Tighten, clean or replace parts accordingly.



ENVIRONMENT PROTECTION

Recycle unwanted materials instead of disposing of them as waste. All tools, accessories and packaging should be sorted, taken to a recycling centre and disposed of in a manner which is compatible with the environment. When the product becomes completely unserviceable and requires disposal, drain any fluids (if applicable) into approved containers and dispose of the product and fluids according to local regulations.



REGISTER YOUR PURCHASE HERE

Note: It is our policy to continually improve products and as such we reserve the right to alter data, specifications and component parts without prior notice.

Important: No Liability is accepted for incorrect use of this product.

Warranty: Guarantee is 12 months from purchase date, proof of which is required for any claim.

Sealey Group, Kempson Way, Suffolk Business Park, Bury St Edmunds, Suffolk. IP32 7AR

 01284 757500

 sales@sealey.co.uk

 www.sealey.co.uk