



# 9L MANUAL/AIR VACUUM OIL & FLUID EXTRACTOR

MODEL NO: **S01168**

Thank you for purchasing a Sealey product. Manufactured to a high standard, this product will, if used according to these instructions, and properly maintained, give you years of trouble free performance.

**IMPORTANT:** PLEASE READ THESE INSTRUCTIONS CAREFULLY. NOTE THE SAFE OPERATIONAL REQUIREMENTS, WARNINGS & CAUTIONS. USE THE PRODUCT CORRECTLY AND WITH CARE FOR THE PURPOSE FOR WHICH IT IS INTENDED. FAILURE TO DO SO MAY CAUSE DAMAGE AND/OR PERSONAL INJURY AND WILL INVALIDATE THE WARRANTY. KEEP THESE INSTRUCTIONS SAFE FOR FUTURE USE.



Refer to instructions



Wear eye protection



Wear protective gloves

## 1. SAFETY

- WARNING!** Ensure Health & Safety, local authority, and general workshop practice regulations are strictly adhered to when using this equipment.
- WARNING!** Disconnect the extractor from the air supply before changing accessories, servicing or performing any maintenance.
- WARNING!** Ensure that you wear protective clothing, gloves, goggles, face mask as appropriate for the fluid being extracted.
- ✓ Keep the extractor clean and maintain it in good condition (use an authorised service agent).
- ✓ Replace or repair damaged parts. Use genuine parts only. Unauthorised parts may be dangerous and will invalidate the warranty.
- ✓ Check extractor connections and fittings before use. When the extractor is turned on check that there are no leaks.
- ✓ Ensure that the extractor's tank capacity exceeds the amount of fluid to be collected.
- ✓ Avoid unintentional starting of the extractor and ensure that the end of the suction tube is fully submerged in the fluid before operating.
- ✓ Keep the work area clean, uncluttered and ensure there is adequate lighting.
- ✓ Maintain correct balance and footing. Ensure the floor is not slippery and wear non-slip shoes.
- ✓ Keep children and unauthorised persons away from the working area.
- ✓ Dispose of waste fluids in accordance with local authority regulations.
- ✓ Use only to extract engine or transmission oils, or similar NON-corrosive fluids. Unit may also be used for the transfer of water.
- WARNING! DO NOT** allow uncontrolled discharge of fluids thus polluting the environment.
- \* **DO NOT** pull or yank any pipes or hoses and **DO NOT** attempt to move the extractor by pulling the hose.
- \* **DO NOT** leave the extractor operating unattended.
- \* **DO NOT** use to extract hazardous or harmful chemicals, solvents, petrol, diesel, kerosene, alkaline or acids. If by chance such fluids are used in the unit, it must be immediately drained and thoroughly cleaned. Use with prohibited fluids will invalidate your warranty.
- \* **DO NOT** store fluids in the extractor's tank. After extracting fluid, it must be emptied into an approved receptacle as soon as possible.
- \* **DO NOT** dismantle, tamper or adapt the extractor for any purpose other than for which it is designed.
- \* **DO NOT** store in areas of high temperature, direct sunlight, rain or snow.
- \* **DO NOT** leave the unit in a pressurised state.
- WARNING!** When the extractor's tank contains liquid that is under pressure **DO NOT** remove or insert the extension tube connector into the inlet/outlet fitting as this may result in a sudden discharge of liquid that could be dangerous.
- ✓ Always press the pressure relief button before connecting or disconnecting the extension tube.
- DO NOT** direct the air line at yourself or others.

## 2. INTRODUCTION

9L Capacity device constructed from composite materials. Uses manual pump or compressed air supply to generate vacuum. Suitable for the extraction of all types of engine, transmission and lubricating oil from cars, motorcycles, marine engines, stationary engines and industrial machinery. Also suitable for low viscosity fluids such as water. Supplied with Ø4, Ø6, Ø8 x 1000mm suction probes, Ø10 x 1000mm extension tube and 1200mm brake bleed tube. Uses probes to extract engine oil through the dipstick tube.

## 3. SPECIFICATION

Model: .....S01168  
Capacity: ..... 9 L  
Suction probes: Ø4x1000, Ø6x1000, Ø8x1000mm, 1200mm Brake bleed tube  
Extension hose: .....Ø10 x 1000mm  
Supply: ..... 90psi(5cfm)

## 4. AIR SUPPLY

When using a workshop air supply, the recommended hook-up is shown below.

- 4.1. Ensure that the air valve (see fig.3) is in the "off" position before connecting to the air supply.
- 4.1.1. You will require an air pressure and an air flow (cfm) according to the specification.
  - WARNING!** Ensure the air supply is clean and does not exceed the pressure quoted.
  - WARNING!** Too high an air pressure and/or unclean air will shorten the life of the extractor due to excessive wear and may be dangerous, causing damage and/or personal injury.



- 4.1.2. Drain the compressor air tank daily.
- 4.1.3. Clean compressor air inlet filter weekly.
- 4.1.4. Line pressure should be increased to compensate for long air hoses (over 8 metres). The minimum bore for hose and fittings 1/4".
- 4.1.5. Keep hoses away from heat, oil and sharp edges. Check hoses for wear and make certain that all connections are secure.
- 4.7. Pull back the sleeve on the quick coupling (See fig.2A) and remove the male threaded air coupling (See fig.2B). Wrap the thread in PTFE tape and screw the coupling into the air valve mounted at the rear of the handle (See fig.2C). **DO NOT** over tighten.

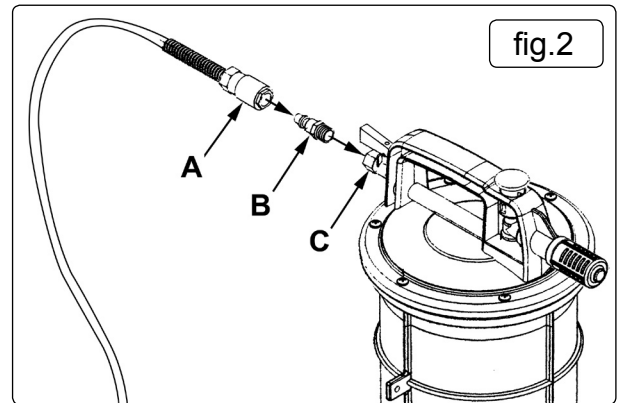
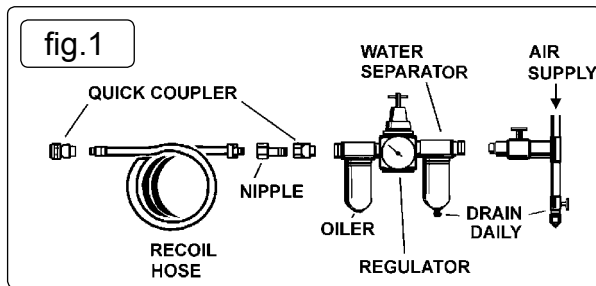

## 5. OPERATION

**NOTE:** Ensure you read, understand and apply the Section 1 Safety Instructions and consult manufacturer's workshop manual for any specific procedures.

### 5.1. AIR OPERATION

- 5.1.1. First ensure that the vehicle is level. Run the engine for approximately five minutes to ensure that the oil is warm. Switch off engine.
- 5.1.2. Remove oil dipstick from engine.
  - **WARNING!** Ensure oil temperature does not exceed 70°C.
- 5.1.3. Insert the appropriate extracting probe into the dipstick tube making sure it reaches the bottom of the sump. Depending on the vehicle it may be necessary to insert the wire supplied in order to keep the tube more rigid as it passes down into the sump. Connect the extracting probe to the main suction tube using the black rubber adaptor. The tubes are a push fit into the adaptor.
- 5.1.4. Position the tank close to the front or side of the vehicle. Connect the main suction tube to the fluid inlet coupling using the black rubber suction tube adaptor as shown below in fig.3.
- 5.1.5. Connect an airline to the coupling at the back of the air valve and turn the air valve off as shown above. Adjust the air source to 90psi with an air flow of 5cfm.
- 5.1.6. To commence draining the sump turn the air valve on and press the button to start the suction as shown below in fig.4. When the fluid being drained reaches the top of the tank the unit will shut down automatically. If the fluid being drained is not sufficient to reach the auto-shut off mechanism the unit can be shut down manually by turning off the air valve.
- 5.1.7. Disconnect the airline. Disconnect the suction tube from the unit by pulling out the fluid inlet coupling (fig.3) and pour the extracted fluid into a suitable container for disposal according to local authority regulations. Remove the extracting probe from the dipstick tube and re-insert the dipstick.

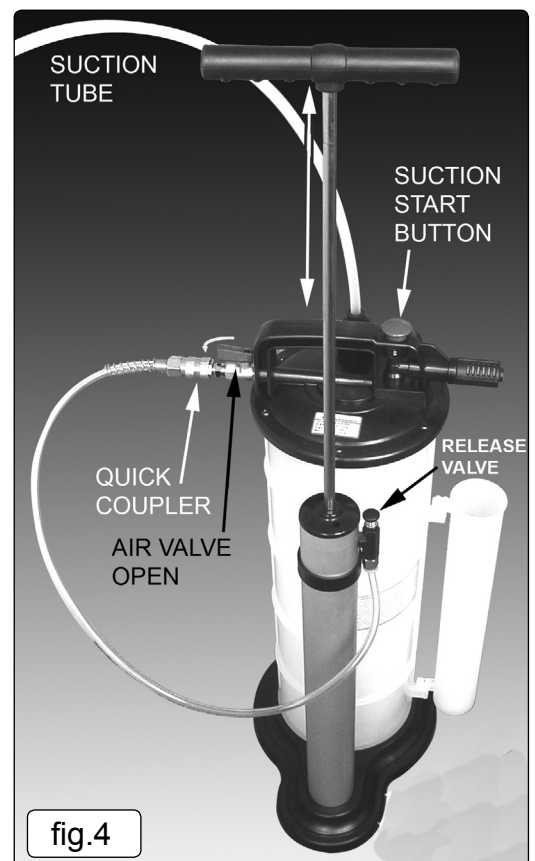
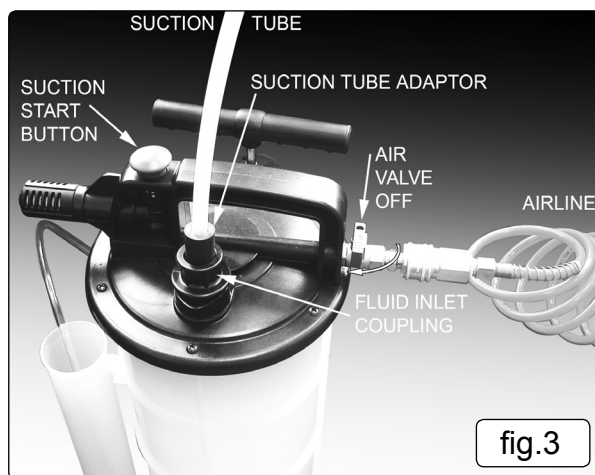

### 5.2. MANUAL OPERATION

**NOTE:** Ensure you read, understand and apply the Section 1 Safety Instructions and consult manufacturer's workshop manual for any specific procedures.

- 5.2.1. Ensure that the vehicle is level. Run the engine for approximately five minutes to ensure that the oil is warm. Switch off engine.
- 5.2.2. Remove the oil dipstick from the engine.
- 5.2.3. Insert the appropriate extracting probe into the dipstick tube making sure it reaches the bottom of the sump.
- 5.2.4. Connect the extracting probe to the extension tube using its black plastic adaptor. The tubes are a push fit into the adaptor.
- 5.2.5. Position the extractor unit close to the front or side of the vehicle. Press fit the 10mm diameter suction tube adaptor to the inlet coupling (fig.3).
  - **WARNING!** Ensure oil temperature does not exceed 70°C.

- ❑ **WARNING!** Before operating the extractor you must press the pressure release valve (fig.4) to dissipate any vacuum or pressure remaining in the tank from previous use.
- 5.2.6. To commence suction, place your foot over the foot rest to steady the unit and start to pump the handle up and down through its full travel. As you pump up and down, the tank will begin to fill. Stop pumping and press release valve to prevent the unit overflowing.
- 5.3. EMPTYING THE UNIT**
- NOTE:** Before emptying the extractor you must press the pressure release valve (fig.4) to dissipate any vacuum or pressure remaining in the tank.
- 5.3.1. Carefully remove the suction probe from the dipstick tube using rag or tissue to prevent any oil drips soiling the engine bay. Replace the dipstick.
- 5.3.2. Disconnect the suction tube and the inlet coupling from the extractor body (fig.3).
- 5.3.3. Empty the extracted fluid into a suitable container. The fluid should be disposed of according to local authority regulations.
  - ✗ **DO NOT** tilt beyond 90°.

## 6. BRAKE BLEEDING

### 6.1. BRAKE BLEEDING SAFETY

- 6.1.1. Dispose of waste liquids in accordance with local authority regulations.
- 6.1.2. Always read and comply with the warnings on the brake fluid container.
- 6.1.3. Wear eye protection and keep skin contact to a minimum. If brake fluid enters eyes rinse with plenty of water and seek medical advice. If swallowed seek medical advice immediately.

❑ **WARNING!** Brake fluid is flammable - keep away from sources of ignition, including hot surfaces e.g. exhaust manifold.

❑ **WARNING!** Brake fluid will damage paintwork. Any spillage should be flushed with water immediately.

### 6.2. BRAKE BLEEDING PROCEDURE

**NOTE: DO NOT** touch the vehicle's brake pedal whilst bleeding the brakes.

Refer to the vehicle manufacturer's instructions for brake bleeding and wheel sequence before proceeding. If no specific instructions from the vehicle manufacturer exist, follow the instructions detailed below.

❑ **WARNING!** Familiarise yourself with the hazards of brake fluid - read manufacturer's instructions on the container.

- 6.2.1. Remove the lid of the vehicle's brake fluid reservoir. Fill the reservoir to its maximum mark.
- 6.2.2. Identify the brake bleeding tube which has a flexible plastic brake nipple connector at one end and a rubber adaptor at the other.
- 6.2.3. Connect the brake bleeding tube to the top of the fluid extractor's tank by pushing the black rubber adaptor into the fluid inlet coupling.
- 6.2.4. Push the flexible plastic brake nipple connector onto the brake nipple on the first wheel and open the nipple about 1/4 of a turn. (See fig.5).
- 6.2.5. Turn on the air valve on the extractor. Press the suction start button (fig.3) to activate air operated unit or operate the pump handle on manual models. A vacuum will be created which will draw the brake fluid from the vehicle's brake system. Operate the unit for a few seconds only to avoid draining the vehicle's brake fluid reservoir entirely.
 

**IMPORTANT:** Check the level of brake fluid in the vehicle's reservoir and top up regularly. If possible a reservoir top up device should be fitted to the brake fluid reservoir.
- 6.2.6. Continue to bleed the system and top up the reservoir until there are no air bubbles visible in the clear tube (See fig.6).
- 6.2.7. Close the brake nipple (See fig.5).
- 6.2.8. Remove the rubber pipe from the brake nipple.
- 6.2.9. Repeat the process at each wheel in turn.

### 6.3. CHANGING THE BRAKE FLUID

- 6.3.1. Repeat the brake bleeding procedure as described above until the master cylinder reservoir is at its minimum level. Fill the reservoir with new brake fluid and continue to bleed the system. Check reservoir level regularly.
- 6.3.2. When new fluid can be seen in the clear tube tighten the brake nipple.
- 6.3.3. Repeat this procedure at every wheel.
- 6.3.4. When brake bleeding and/or fluid changing is complete, test action of the brake pedal to ensure that the brakes are working before driving the vehicle.
- 6.3.5. Apply copper grease to the brake bleed nipples before and after the brake bleeding procedure to eliminate the possibility of seized or broken nipples when the brakes are next bled (See fig.7).

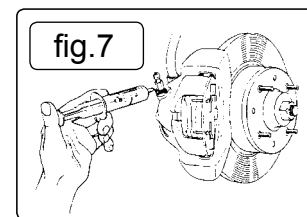
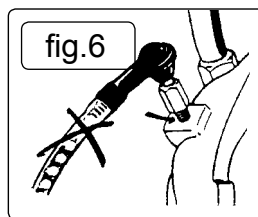
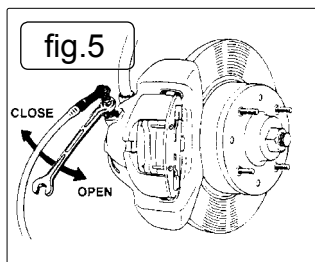

## 7. MAINTENANCE

- 7.1. Keep the unit clean, wipe off any fluid spillage. Keep the suction tubes clean and clear of blockages. Check that all tubes, hoses and connections are in good condition.

Parts support is available for these products. Please email [sales@sealey.co.uk](mailto:sales@sealey.co.uk) or telephone 01284 757500



**ENVIRONMENT PROTECTION**

Recycle unwanted materials instead of disposing of them as waste. All tools, accessories and packaging should be sorted, taken to a recycling centre and disposed of in a manner which is compatible with the environment. When the product becomes completely unserviceable and requires disposal, drain any fluids (if applicable) into approved containers and dispose of the product and fluids according to local regulations.

**Note:** It is our policy to continually improve products and as such we reserve the right to alter data, specifications and component parts without prior notice.

**Important:** No Liability is accepted for incorrect use of this product.

**Warranty:** Guarantee is 12 months from purchase date, proof of which is required for any claim.

**Sealey Group, Kempson Way, Suffolk Business Park, Bury St Edmunds, Suffolk. IP32 7AR**



**01284 757500**



**01284 703534**



**[sales@sealey.co.uk](mailto:sales@sealey.co.uk)**



**[www.sealey.co.uk](http://www.sealey.co.uk)**