



170BAR PRESSURE WASHER - LANCE CONTROLLED PRESSURE WITH TSS & ROTABLAST® NOZZLE

MODEL NO: PW2400

Thank you for purchasing a Sealey product. Manufactured to a high standard, this product will, if used according to these instructions, and properly maintained, give you years of trouble free performance.

IMPORTANT: PLEASE READ THESE INSTRUCTIONS CAREFULLY. NOTE THE SAFE OPERATIONAL REQUIREMENTS, WARNINGS & CAUTIONS. USE THE PRODUCT CORRECTLY AND WITH CARE FOR THE PURPOSE FOR WHICH IT IS INTENDED. FAILURE TO DO SO MAY CAUSE DAMAGE AND/OR PERSONAL INJURY AND WILL INVALIDATE THE WARRANTY. KEEP THESE INSTRUCTIONS SAFE FOR FUTURE USE.



Refer to instruction manual



Wear eye protection



Wear ear protection



Wear safety footwear



Wear protective clothing



DO NOT direct jet against yourself, other persons, animals, electrical equipment or the machine itself.

1. SAFETY

1.1. ELECTRICAL SAFETY

- WARNING!** It is the user's responsibility to check the following:
Check all electrical equipment and appliances to ensure that they are safe before using. Inspect power supply leads, plugs and all electrical connections for wear and damage. Sealey recommend that an RCD (Residual Current Device) is used with all electrical products. You may obtain an RCD by contacting your local Sealey stockist.
If the pressure washer is used in the course of business duties, it must be maintained in a safe condition and routinely PAT (Portable Appliance Test) tested.
Electrical safety information, it is important that the following information is read and understood.
- 1.1.1. Ensure that the insulation on all cables and on the appliance is safe before connecting it to the power supply.
- 1.1.2. Regularly inspect power supply cables and plugs for wear or damage and check all connections to ensure that they are secure.
Important: Ensure that the voltage rating on the appliance suits the power supply to be used and that the plug is fitted with the correct fuse - see fuse rating in these instructions.
 - × **DO NOT** pull or carry the appliance by the power cable.
 - × **DO NOT** pull the plug from the socket by the cable.
 - × **DO NOT** use worn or damaged cables, plugs or connectors. Ensure that any faulty item is repaired or replaced immediately by a qualified electrician.
- 1.1.3. This product is fitted with a BS1363/A 3 pin plug.
If the cable or plug is damaged during use, switch the electricity supply and remove from use. Ensure that repairs are carried out by a qualified electrician.
Replace a damaged plug with a BS1363/A 3 pin plug. If in doubt contact a qualified electrician.
 - a) Connect the GREEN/YELLOW earth wire to the earth terminal 'E'.
 - b) Connect the BROWN live wire to the live terminal 'L'.
 - c) Connect the BLUE neutral wire to the neutral terminal 'N'.Ensure that the cable outer sheath extends inside the cable restraint and that the restraint is tight. Sealey recommend that repairs are carried out by a qualified electrician.

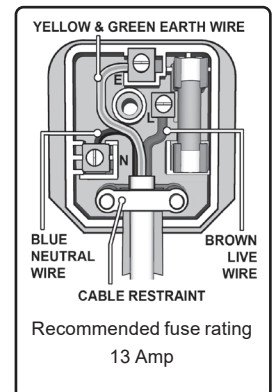

1.2. GENERAL SAFETY

- WARNING!** Water and electricity are dangerous partners. Be extremely cautious and ALWAYS be aware that this device uses an electric motor. Always plug into a RCD (See electrical safety above). Unplug from mains before changing accessories or servicing.
- WARNING! DO NOT** use the washer if any part of the unit, gun, nozzle, detergent tank, hose or cables is damaged. Replace or repair using genuine parts only. Unauthorised parts may be dangerous and will invalidate your warranty. Always check connections are correctly secured and not cracked or damaged in any way before using the machine.
- WARNING!** Use washer on a flat, levelled surface, in an upright position. Failure to do so will invalidate your warranty.
NEVER lay the washer down during use.
- ✓ Ensure you comply with all local water supply regulations. Power washers may only be connected to mains water supply if a check valve is installed in the supply hose, or at the tap outlet.
- ✓ The supply hose must be reinforced, and have an internal diameter of 1/2". The water supply must be at least equal to the cleaner capacity. The water temperature must NOT exceed 122°F (50°C). The water supply pressure must NOT exceed 12bar.
- ✓ Always be aware of the hazards that may occur during use. Study all applications and limitations of the washer before use.
- ✓ Use where air can freely circulate around the washer to avoid the machine overheating.
- ✓ Keep the washer in good condition. Use an authorised service agent to service the unit.
- ✓ Wear adequate protective clothing, goggles and anti-slip rubber soled footwear.
- ✓ Position the washer as near to the water supply as possible.
- WARNING!** Ensure all persons and animals keep at a minimum distance of 15mtr from the washer when in use.
- WARNING!** The pressure washer must only be used with clean water. Unfiltered water or corrosive chemicals must not be used as these will damage the cleaner.
- ✓ Ensure the nozzle is aimed correctly at the work surface before switching on the machine.
- ✓ Before activating the trigger, grip the gun firmly to counteract the recoil from the high pressure water jet.
- WARNING!** Avoid sudden bursts of water as these will cause water pressure to drop and put extreme pressure on hoses and connectors.
- ✓ If, during operation, power failure occurs turn the electricity and water off for safety reasons.

- ❑ **WARNING!** The high pressure jet will cause loose particles to be propelled at high speed, which may cause serious injury.
 - ❑ **WARNING! DO NOT** operate the machine without a water supply. Dry running can seriously damage the unit.
 - ❑ **WARNING! DO NOT** leave the washer switched on for more than 15 minutes without operating the trigger.
 - ✖ **DO NOT** obstruct ventilation grilles during operation.
 - ✖ **DO NOT** use the washer with flammable or toxic liquids or any other product. Use only recommended detergent. Unapproved detergents may corrode the machine cover and accessories.
 - ✖ **DO NOT** jam the trigger in the operating position.
 - ✖ **DO NOT** adjust any internal control valves, as they have been factory set.
 - ✖ **DO NOT** connect other appliances to the machine inlet or outlet.
 - ✖ **DO NOT** use hoses and fittings other than those designed for use with this machine.
 - ✖ **DO NOT** move the unit by pulling the hoses or electrical cables. Use the handle and transport by means of the wheels.
 - ✖ **DO NOT** touch plug with wet hands. To avoid the risk of electrocution keep all connections dry and off the ground.
 - ✖ **DO NOT** direct jet against yourself, other persons, animals, electrical equipment or the machine itself.
 - ✖ **DO NOT** use washer if you are tired or under the influence of alcohol, drugs or intoxicating medication.
 - ✖ **DO NOT** allow children or untrained persons to operate the washer.
 - ❑ **WARNING!** Discharge residual pressure before disconnecting the washer hose. Pressure left in unit may cause injury.
 - ✓ After use, disconnect washer from electrical mains and water supply and store in a safe, dry, childproof area.
 - ✓ Protect from freezing conditions during winter.
- NOTE:** This appliance is not intended for use by persons (including children) with reduced physical, sensory or mental capabilities or lack of experience and knowledge, unless they have been given supervision or instruction concerning the use of the appliance by a person responsible for their safety. Children should be supervised to ensure that they do not play with the appliance.

2. INTRODUCTION

Features pressure controlled lance with three settings. Low power for soft cleaning, Medium power for vehicles and High power for patio and brickwork. Quick release nozzle system allows for fast selection between fan and Rotablast® nozzle. Pressure gun includes lock to avoid unintended activation. 2400W motor produces up to 170bar of pressure with an impressive 450L/hr flow rate. Automatic Total Stop System (TSS) which switches the motor on and off when the trigger is operated, prolonging motor life. 5m inline pressurised hose reel for ease of use. Built in detergent tank that filters into the jet stream perfect for use with the Low power mode with no need to change the lance. 5m power cable and heavy-duty wheels.

3. SPECIFICATION

Model No:..... **PW2400**
IP Rating: IPX5
Maximum Pressure: 170bar
Effective Cleaning Power: 170bar
Maximum Water Flow:..... 450L/hr
Motor Power:.....2400W
Maximum Inlet Pressure: 12bar
Nozzles: Rotablast® and Fan
Peak Water Temperature: 50°C
Rated Pressure: 120bar
Water Flow Rate: 6.5/7.5L/min
Supply:.....230V~13A
Total Stop System (TSS):..... Yes
Rotablast Nozzle:..... Yes
Hose Length:.....5m

Noise power/Pressure:.....89.9/76.9dBA
 Vibration/Uncertainty:..... 1.309/1.5m²

4. CONTENTS

Item		Item	
1	Trigger Gun	11	Power Cable
2	Lance	12	Cable Hook
3	Cleaning Pin	13	ON/OFF Switch
4	Gun Holder	14	High Pressure Hose
5	N/A	15	Trigger Lock Catch
6	Instructions	16	Reel Handle
7	Pack of Screws	17	Nozzle
8	Gun Saddle	18	Control Panel
9	Inlet Connector (plus filter)	19	Battery
10	Water Inlet	20	Remote Control Panel

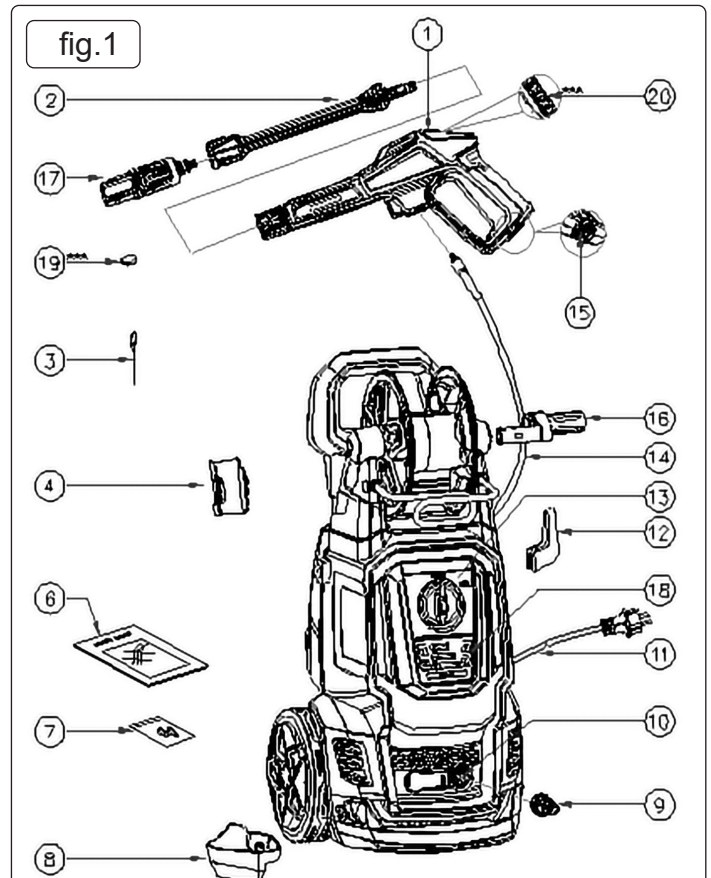

5. SET UP

5.1. ACCESSORIES

- 5.1.1. To fit the battery for the remote operation via the gun handle, fit the supplied battery (CR2450/3V) into the compartment on the top surface of the gun. Carefully prise the lid open using a wide bladed screwdriver or similar tool. Replace lid when battery is fitted.
- 5.1.2. Fix the gun saddle, gun holder and power cable hook to the unit (fig.1) using the supplied fixings.

5.2. CONNECTING THE WATER SUPPLY

- 5.2.1. Use a reinforced hose pipe with an internal diameter of 1/2" and connect to the mains water supply. Before attaching the hose to the pressure washer, flush the hose through with some clean water to remove any foreign matter from within the hose.
- 5.2.2. Connect the water inlet connector (fig.1.9) to the inlet on the front of the machine (fig.1.10) ensuring that the internal filter is present.
- 5.2.3. Connect the water supply hose to the connector.

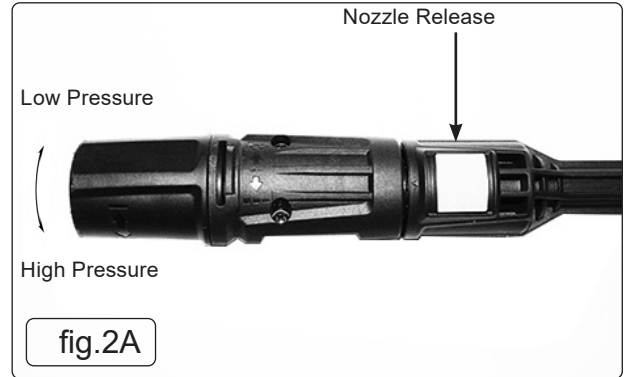

5.3. CONNECTING THE HIGH PRESSURE HOSE

- 5.4. Insert the high pressure hose into the inlet on the underside of the trigger housing (fig.2). To disconnect the hose, depress the button in front of the connection point and withdraw the connector. The PW2400 is pre-connected to the unit via the inside of the hose storage reel.

5.5. ASSEMBLING THE LANCE AND NOZZLE

- 5.5.1. Push the lance nozzle into the gun body and fasten in place by twisting it 90° ensuring that the connection is tight.
- 5.5.2. Depress the button on the lance head and insert the nozzle ensuring alignment of the groove in the lance head.
- WARNING!** Ensure the nozzle is locked into position, failure to ensure this could result in the nozzle being ejected under high pressure when operating the gun.

5.6. CONNECTING TO THE MAINS ELECTRICAL SUPPLY

- WARNING!** Ensure the On/Off switch (fig.1.13) is in the 'Off' position.
- 5.6.1. Use an RCD plugged into a 13A mains socket (see Section 1.1 Electrical Safety).

5.7. WIRELESS PAIRING

- 5.7.1. To enter pairing, depress and hold Level 1 and Level 3 buttons (fig.4) for 2 seconds. The indicator light (fig.4.E) will flash. To exit pairing, depress and hold the Level 1 button for 2 seconds.
- 5.7.2. To pair the gun to the unit, depress the multi function button (fig.3) for 5 seconds. The indicator light will flash and when the units are paired, the indicator light will go off.
- 5.7.3. Once paired, the current operating level light will illuminate. If pairing fails the unit will exit pairing mode after 10 seconds.
- NOTE:** Once paired, the unit can only be operated by the remote control.

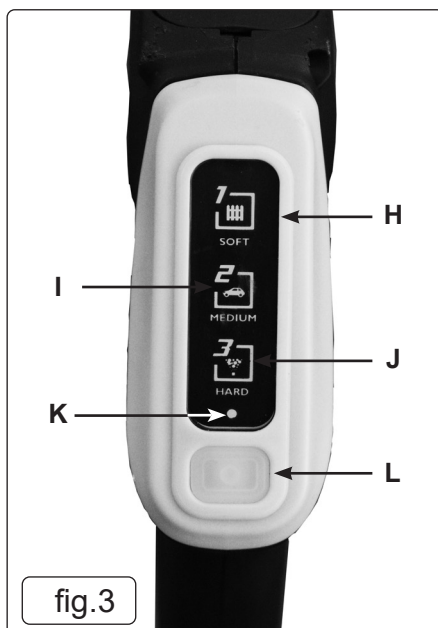

Item	Function
H - Level 1 Indicator	After switching the level on the remote control, the Indicator shows the currently set level, and then the indicator goes out.
I - Level 2 Indicator	
J - Level 3 Indicator	
K - Status Indicator	1. The status indicator flashes quickly in pairing mode. 2. The status indicator is off when successfully paired with the host. 3. The status indicator flashes 3 times slowly when the battery is low, indicating that the battery needs to be replaced.
L - Multi-function Button	1. Switch working level button 2. Wireless pairing mode button 3. Exit wireless pairing mode button

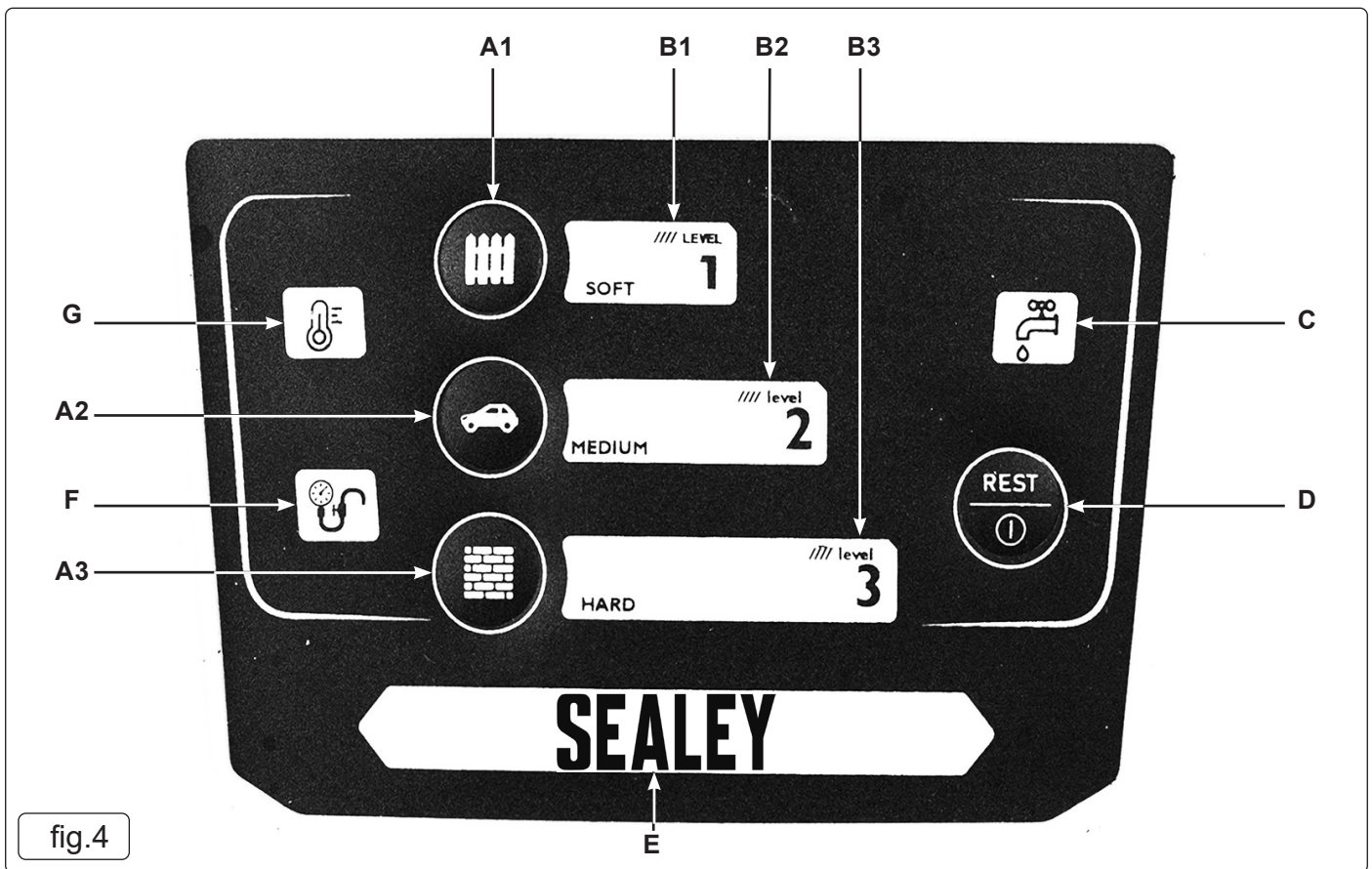

fig.4

Item	Function
A1. Level 1# button	1. Set working level button 2. Wireless pairing mode button (long press Level 1# button and Level 3# button at the same time for 2 seconds). 3. Exit wireless pairing mode button (long press one button for 2 seconds).
A2. Level 2# button	
A3. Level 3# button	
B1. Level 1 indicator	The indicator light shows the current level
B2. Level 2 indicator	
B3. Level 3 indicator	
C. Water shortage warning indicator	1. The indicator light is red : the water supply is insufficient or unstable, and the motor stops running. 2. The indicator light is green: the water supply is stable.
D. Multi - function button	Run/pause/reset
E. Running indicator	1. The indicator light is on: the machine is operating normally 2. The indicator light is off : the machine stops running 3. The indicator light flashes : the machine is in wireless pairing mode
F. Holding pressure indicator	The indicator light is on, and the pump is in a pressure-holding state
G. Over temperature warning indicator	1. The motor temperature is normal and the indicator light is green. 2. When the motor temperature exceeds the safe value, the indicator light turns red and the motor stops running.

6. OPERATION

- ❑ **WARNING!** Ensure you read, understand and apply Section 1 safety instructions.
- ❑ **WARNING!** Dry running can seriously damage the unit.
- ❑ **WARNING!** Use washer on a flat, levelled surface, in an upright position. Failure to do so will invalidate your warranty. Never lay the washer down during use.
- ❑ **WARNING! DO NOT** leave washer switched on for more than 15 minutes without operating trigger.
IMPORTANT! The washer motor will stop as soon as the gun trigger is released and will restart when the trigger is squeezed. Always allow at least 5 seconds between releasing the trigger and restarting.

6.1. PRIMARY CHECKS

- 6.1.1. Check that the inlet filter is clean; pump delivery and pressure will be reduced if blocked. Never use the machine without a filter (which is fitted inside the inlet connector fig.1.9). Ensure that the water supply, high pressure hose and gun are correctly connected, and that air can circulate around the washer freely.

6.2. SAFETY CATCH OPERATION

6.2.1. To prevent inadvertent operation of the unit, the safety catch in the base of the trigger should always be engaged when the gun is not in use (fig.5).

6.3. BLEEDING THE GUN

6.3.1. It is very important to bleed the gun before using the pressure washer. Squeeze the trigger BEFORE turning the electrical supply on. This allows any air trapped inside the pressure washer and gun to be removed before using the unit. Continue holding the trigger for approximately one minute to allow any excess air out of the unit. Water will flow through the gun at low pressure during this procedure.

6.4. PRESSURE SETTING

6.4.1. There are three levels of pressure settings (fig.4). Level 1 is the setting suitable for cleaning fences, cement terraces etc. Level 2 setting is suitable for cleaning vehicles, boats, motorcycles etc. Level 3 setting is suitable for cleaning barbecue grills, garden tools etc. **NOTE:** The default level at start up is Level 2.

6.5. OPERATING THE MACHINE

6.5.1. Hold the spray gun firmly to counteract the recoil caused by the high pressure of the water. Before switching on, ensure that the lance is not directed at people, objects or animals prior to being directed at the object to be cleaned.

6.5.2. It is recommended that the trigger is depressed before switching on the unit before every use. This reduces the back pressure and amperage draw which prevents fuses blowing.

6.5.3. Switch the machine on by turning the switch to the 'ON' position (fig.1). Release the handle safety catch (fig.5). Point the lance at the object to be cleaned and depress the trigger fully. When the trigger is released the motor will switch off automatically.

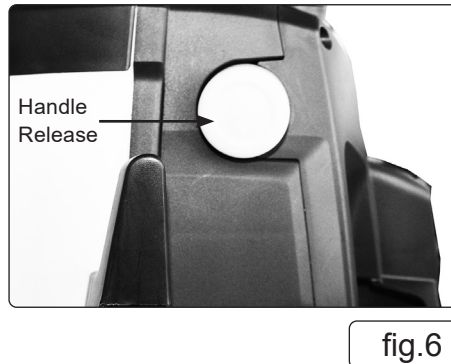
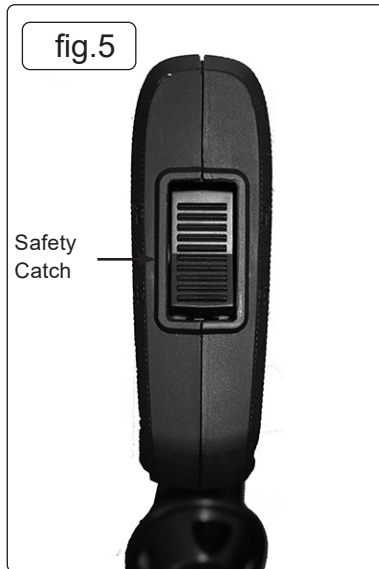

6.6. ADJUSTING THE SPRAY PATTERN

6.6.1. The fan nozzle can be adjusted from pencil point to fan jet by rotating the body of the nozzle (fig.2A)

WARNING! The pencil point setting is very aggressive. It is recommended that for most cleaning applications, a 20° spray angle is used to avoid damage to the surface being sprayed.

6.7. USING DETERGENT

6.7.1. The detergent container is located on the rear of the unit. Add detergent (maximum volume 1 litre).

6.7.2. Rotate the nozzle to the Low Pressure setting as indicated on the nozzle body (fig.2A).

6.7.3. When the unit is operated, detergent will be drawn into the water flow.

6.7.4. To prevent detergent inclusion, reset the nozzle to the High Pressure setting as indicated on the nozzle body (fig.2A).

6.8. TELESCOPIC HANDLE

6.8.1. To adjust the handle depress the button on the side of the unit (fig.6) and move handle either up or down. When it is in the correct position, a click will be heard and the handle will be held in place.

6.9. WHEN WASHING IS COMPLETED

6.9.1. Switch the power supply off by turning switch to 'Off' position (fig.1).

6.9.2. Turn off the water supply tap.

6.9.3. Discharge residual pressure by pressing the trigger until no more water comes out of the nozzle.

WARNING! Failure to discharge pressure could result in personal injury.

6.9.4. Disconnect the inlet and high pressure outlet hoses.

6.9.5. Wipe the machine clean and dry and store in a clean, safe, dry, childproof location.

NOTE: a) **DO NOT** leave motor switched on for more than 15 minutes without operating trigger.

b) If the water pressure drops (e.g. someone else using the same water supply), the washer will not operate correctly. Immediately switch the motor off and wait until the pressure is restored.

7. MAINTENANCE

WARNING! Ensure the pressure washer is switched off and unplugged from the mains electrical power supply and turned off at the mains water tap before performing any maintenance tasks.

Check, clean or renew the inlet filter (which is fitted inside the inlet connector fig.1.9) after every 50 hours of use.

Use only genuine Sealey spares for this machine. Failure to do so could result in personal injury and will invalidate the warranty.

7.1. NOZZLES

7.1.1. Ensure that both nozzles are kept clean and free of debris.

7.1.2. The variable nozzle should be lubricated regularly. Clogging of the nozzle causes the pump pressure to be too high and cleaning is immediately required.

7.1.3. Separate the nozzle from the lance.

- 7.1.4. Clear the nozzle of any debris.
- 7.1.5. Flush the nozzle with water.
- 7.1.6. Reconnect the nozzle to the lance. Ensure that the nozzle connection is tight.
- 7.2. WATER FILTER**
- 7.2.1. The pressure washer is equipped with a water inlet filter to protect the pump (fig.1.9).
- 7.2.2. To clean the conical filter, remove quick fit connection and the filter from the pump inlet.
- 7.2.3. Back flush the filter to clean.
- 7.2.4. Replace filter and quick connection immediately to prevent any ingress of foreign matter into the pump.
- 7.3. COOLING SYSTEM**
- 7.3.1. The air vents, in and around the pressure washer, must be kept clean and free of any obstructions to ensure proper air cooling of the motor during operation.
- WARNING!** Prevent water from penetrating the vents of the pressure washer to minimise the risk of damage to the machine and to reduce the risk of shock to the operator.
- 7.4. GENERAL**
- 7.4.1. Check unit, gun, nozzle, hose, connections and cables for damage. Immediately replace or repair with genuine parts.
- 7.5. STORAGE**
- 7.5.1. Store in a location where the washer will not be subject to freezing conditions.
- 7.5.2. Make sure that the pressure washer has been drained of water and remove the hoses.

8. TROUBLESHOOTING

Symptom	Cause	Recommended action
Machine refuses to start	Machine not plugged in Defective socket Fuse has blown Defective extension cable	Plug in machine. Try another socket. Replace fuse, switch off other machines. Try without the extension cable.
Fluctuating pressure	Pump sucking air Valves dirty, worn out or stuck Pump seals worn out	Check that hoses and connections are airtight. Clean and replace or refer to local distributor. Clean and replace or refer to local distributor.
Machine stops suddenly	Fuse has blown Incorrect mains voltage Over temperature warning light is red Nozzle partially blocked Water shortage warning light is red	Replace fuse. Switch off other machines. Check that the mains voltage corresponds to specification on the model tag. Leave the washer for 5 minutes to cool down, press the Multi - function button on the panel switch to restart. Clean the nozzle. Check if the water source is connected and turned on, and if the water supply is sufficient
Fuse blows	Fuse too small	Change to an installation higher than the amp. Consumption of the machine. Try without the extension cable.
Machine pulsating	Air in inlet hose/pump Nozzle partially blocked Water filter blocked Hose kinked	Allow machine to run with open trigger until regular working pressure resumes. Clean the nozzle. Clean the filter. Straighten out hose.
Machine starts, but no water comes out	Pump/hose or accessory frozen Water shortage warning light is red Water filter blocked Nozzle blocked	Wait for pump/hoses or accessory to thaw. Check if the water source is connected and turned on, and if the water supply is sufficient Clean the filter. Clean the nozzle.



ENVIRONMENT PROTECTION

Recycle unwanted materials instead of disposing of them as waste. All tools, accessories and packaging should be sorted, taken to a recycling centre and disposed of in a manner which is compatible with the environment. When the product becomes completely unserviceable and requires disposal, drain any fluids (if applicable) into approved containers and dispose of the product and fluids according to local regulations.



WEEE REGULATIONS

Dispose of this product at the end of its working life in compliance with the EU Directive on Waste Electrical and Electronic Equipment (WEEE). When the product is no longer required, it must be disposed of in an environmentally protective way. Contact your local solid waste authority for recycling information.

Note: It is our policy to continually improve products and as such we reserve the right to alter data, specifications and component parts without prior notice.

Important: No Liability is accepted for incorrect use of this product.

Warranty: Guarantee is 12 months from purchase date, proof of which is required for any claim.

Sealey Group, Kempson Way, Suffolk Business Park, Bury St Edmunds, Suffolk. IP32 7AR



01284 757500



sales@sealey.co.uk



www.sealey.co.uk