



INSTRUCTIONS FOR:
PREMIER AIR/HYDRAULIC PRESSES
20 & 30 TONNE FLOOR TYPE WITH SLIDING
RAM AND FOOT PEDAL
 MODEL NO'S **PPF301, PPF501**

Thank you for purchasing a Sealey product. Manufactured to a high standard, this product will, if used according to these instructions and maintained properly, give you years of trouble free performance.

IMPORTANT: PLEASE READ THESE INSTRUCTIONS CAREFULLY. NOTE THE SAFE OPERATIONAL REQUIREMENTS, WARNINGS & CAUTIONS. USE THE PRODUCT CORRECTLY AND WITH CARE FOR THE PURPOSE FOR WHICH IT IS INTENDED. FAILURE TO DO SO MAY CAUSE DAMAGE AND/OR PERSONAL INJURY AND WILL INVALIDATE THE WARRANTY. KEEP THESE INSTRUCTIONS SAFE FOR FUTURE USE.



Refer to Instruction
Manual

Wear Eye
Protection

1. SAFETY

- ✓ Familiarise yourself with the applications, limitations and hazards of the press.
- ✓ Maintain the press in good condition (use an authorised service agent).
- ✓ Replace or repair damaged parts. *Use recommended parts only. Unauthorised parts may be dangerous and will invalidate the warranty.*
- ✓ Keep the press clean for best and safest performance.
- ✓ Locate the press in a suitable work area, on a surface that is stable, level, dry, not slippery, and capable of sustaining the load.
- ✓ Keep area clean and tidy and free from unrelated materials, and ensure there is adequate lighting.
- ☐ **WARNING!** Always wear approved eye or face protection when operating the press.
- ✓ Remove ill fitting clothing. Remove ties, watches, rings and other loose jewellery, and contain long hair.
- ✓ Keep hands and body clear of the work table when operating the press.
- ✓ Maintain correct balance and footing. **DO NOT** over reach. Ensure the floor is not slippery and wear non-slip shoes.
- ✓ Keep children and unauthorised persons away from the working area.
- ✗ **DO NOT** use the press for a task it is not designed to perform.
- ✗ **DO NOT** adjust or tamper with the safety valve, or make any modifications to the press.
- ✗ **DO NOT** exceed the rated capacity of the press. Avoid applying excessive force, use the pressure gauge to determine the applied load.
- ✗ **DO NOT** allow the workpiece or the arbor plates to fall from the press table
- ✗ **DO NOT** get the press wet or use in damp or wet locations or areas where there is condensation.
- ✗ **DO NOT** operate the press when you are tired or under the influence of alcohol, drugs or intoxicating medication.
- ✗ **DO NOT** climb upon the press.
- ✗ **DO NOT** use if damaged, or if press has been subjected to a shock load.
- ✗ **DO NOT** operate the press if any parts are missing as this may cause failure and/or possible personal injury.
- ✗ **DO NOT** use the press to compress a spring or any other item that could disengage and cause a potential hazard.
- ✗ **DO NOT** stand directly in front of loaded press and never leave loaded press unattended.
- ✗ **DO NOT** allow untrained persons to operate the press.
- ▲ **DANGER!** This model is purpose designed to withstand greater loads than the hydraulic unit can develop. For safety reasons, always ensure the workpiece and press tools are secured on the table and will not flex or suddenly give way, causing danger to operator or the workpiece.
- ☐ **WARNING: DO NOT use brake fluid or any fluid other than a good quality jack oil, such as SEALEY HYDRAULIC JACK OIL, as this may cause serious damage to the press and will invalidate the warranty.**
- ✓ When not in use, release pressure from the pump and clean the press. Stand or store the arbors in a safe, childproof location.

2. INTRODUCTION

Professional range of floor and bench mount presses, ranging from 15tonne to 50tonne. Hydraulic elements are mounted in the frame to maximise workspace and protect components. Floor models incorporate a fast approach feature (foot pedal or handle operated depending on model). Model No's PPF301 and PPF501 are air/hydraulic and fully operated by foot pedal to keep hands free for fine positioning of the workpiece. Suitable for workshop use or by the serious motoring enthusiast.

3. SPECIFICATION

| | | |
|--------------------------------|-------------------------|---------------|
| Model No: | PPF301 | PPF501 |
| Bench or Floor Mounting: | Floor | Floor |
| Type: | Air/Hydraulic | Air/Hydraulic |
| Capacity: | 30tonne | 50tonne |
| Ram Stroke: | 195mm. | 195mm |
| Ram Ø: | 60mm. | 60mm |
| Lateral Ram Travel: | 250mm. | 230mm |
| Maximum Height - Ram to Table: | 470mm. | 465mm |
| Minimum Height - Ram to Table: | 85mm. | 80mm |
| Table Aperture: | 165mm. | 165mm |
| Working Table Depth: | 190mm. | 190mm |
| Working Table Width: | 530mm. | 720mm |
| Overall Height: | 1920mm. | 1920mm |
| Gauge Included: | Yes. | Yes |
| Weight: | 180kg. | 225kg |

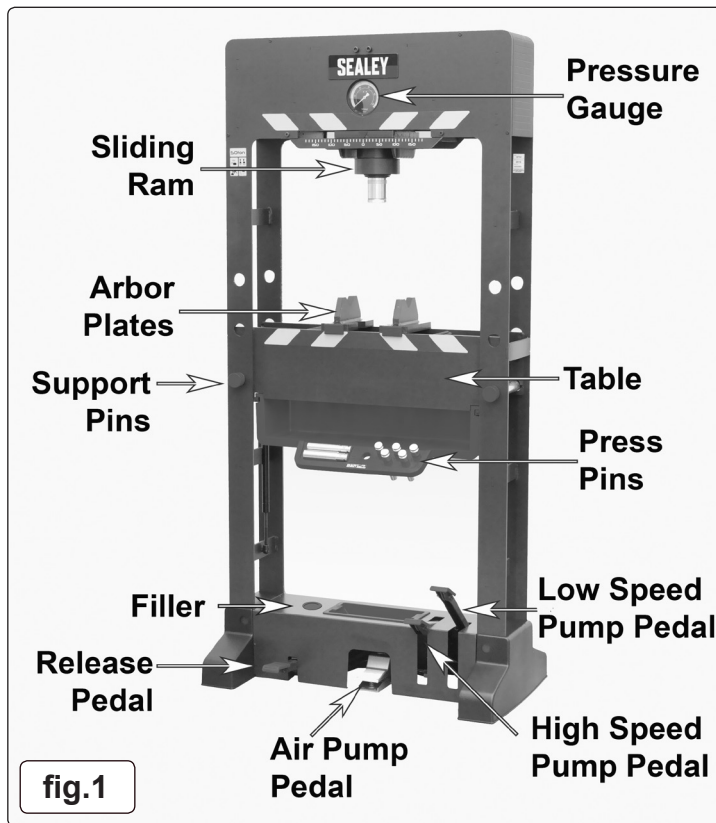

4. ASSEMBLY

4.1. Fitting Feet.

Raise the press to remove the transit supports and replace with the permanent feet (fig.2).

- ☐ **WARNING: Be aware that this unit is top-heavy.**

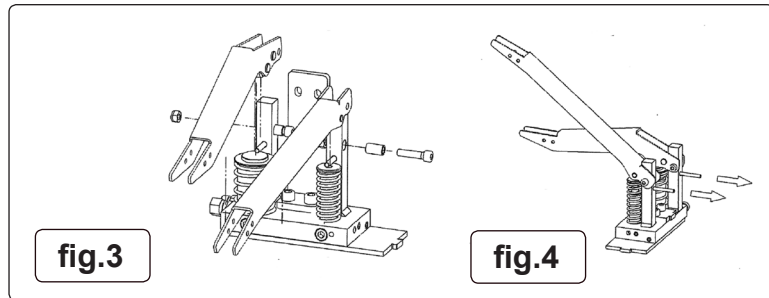
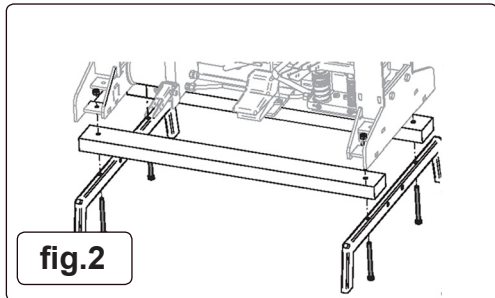

4.2. Air Motor

Connect the air motor to the base plate as in figs.6 and 7.

4.3. Fitting Pedals

- 4.3.1. Fit the pump pedal levers to the pivots using the fixings provided (fig.3).
- 4.3.2. Once the pedal levers are restraining the pump pistons, remove the pins from behind (fig.4).
- 4.3.3. Place the end caps over the feet and lower the pedal housing over the pedals and end caps (fig.5).
- 4.3.4. Screw the pedal covers over the end caps to secure.
- 4.3.5. Fix the pedals to the pedal levers (fig.8)

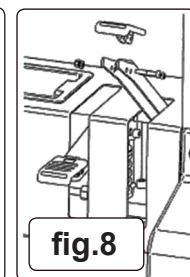
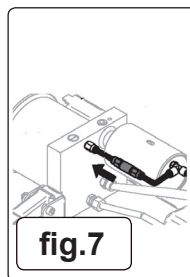
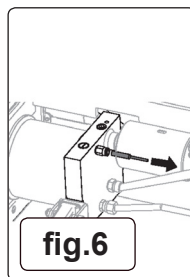
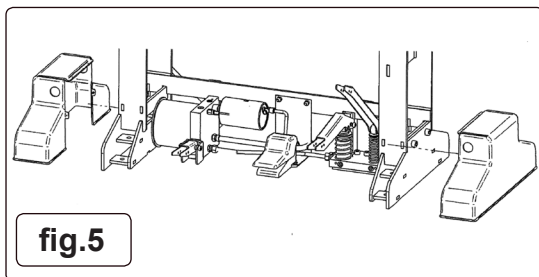

4.4. Air Supply

- 4.4.1. Connect the 1/4\"/>
- 4.4.2. An air supply pressure of between 7 and 10bar (100 -145psi) is recommended.

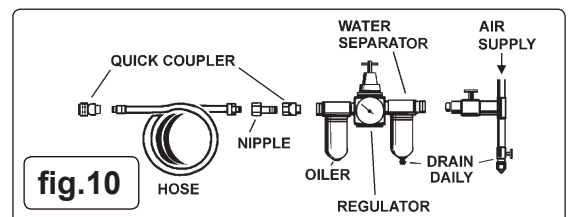

5. OPERATION

5.1. Purging the Hydraulic System

- 5.1.1. Prior to first use, any air in the hydraulic system should be purged.
- 5.1.2. Before purging, ensure that the reservoir (fig.11) is topped up with hydraulic fluid.
- 5.1.3. Each pump will need to be purged separately. To do this:
Press the release pedal and operate the low speed pump for about 10 strokes.
- 5.1.4. Allow the release pedal to rise and operate again for 10 strokes; the ram should descend.
- 5.1.5. Pressing the release pedal should allow the ram to retract.
- 5.1.6. Repeat for the high speed pump and the air pump (keep the air pump pedal depressed for about 10 strokes).
- 5.1.7. If the ram fails to move smoothly, repeat the process.
- 5.1.8. Check the oil level again and top up if necessary.

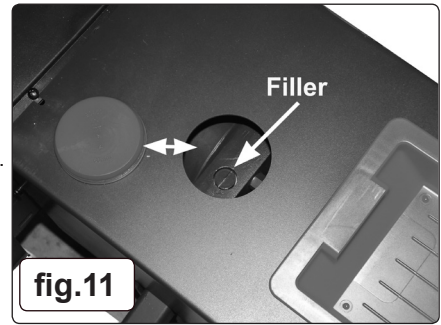

5.2. Using the Press

- 5.2.1. Raise or lower the table to the required height. The table is counterbalanced by gas struts to enable easy movement.
- 5.2.2. Insert the support pins beneath the table at the required height.
- 5.2.2. The ram can be moved laterally by applying firm force. This allows pressing off-centre.
- 5.2.3. Insert the required saddle or press pin into the ram head (fig.12) and secure with the grub screw.
- 5.2.4. Locate the arbor plates in the correct position to support the workpiece and secure the workpiece to the arbors.
- WARNING:** the arbor plates supplied with PPF501 are rated at 30tonnes. When pressing more than 30tonnes, therefore, the workpiece needs to be spread across two arbor plates.
- 5.2.5. Use either the high speed manual pump or the air/hydraulic pump to lower the ram to the workpiece. For final pressing, the low speed manual pump will give finer control and feel.
- 5.2.6. Press the release pedal to retract the ram.
- 5.2.7. When not in use, ensure that the ram is retracted fully and that the air supply is disconnected.

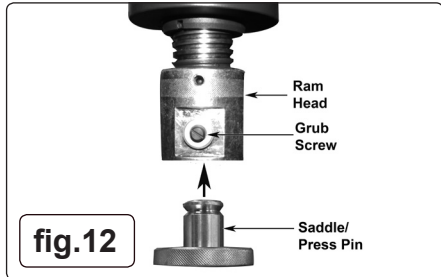

6. MAINTENANCE

Note: Maintenance and repair must only be carried out by qualified person. Contact your Sealey stockist for details.

- 6.1 Always keep the press clean, dry and lubricate all moving parts at regular intervals.
- 6.2 If the performance of the press deteriorates, purge the hydraulic circuit as in section 5.1.
- 6.2. Should you need to check or replace oil ensure piston is fully retracted. Remove the oil reservoir filler plug (fig.11) and top up using Sealey hydraulic jack oil. **DO NOT** use brake fluid. Contact your local Sealey dealer for details. After filling purge the system to remove any air.

Owing to their size and weight, hydraulic products should ideally be repaired by local service agents. We have service / repair agents in most parts of the UK. Before returning your product please call our technical helpline on **01284 757505** for advice and trouble shooting guidance.

If the jack is under guarantee please contact your stockist.

ENVIRONMENT PROTECTION



Recycle unwanted materials instead of disposing of them as waste. All tools, accessories and packaging should be sorted, taken to a recycling centre and disposed of in a manner which is compatible with the environment. When the product becomes completely unserviceable and requires disposal, drain any fluids (if applicable) into approved containers and dispose of the product and fluids according to local regulations.

Note: It is our policy to continually improve products and as such we reserve the right to alter data, specifications and component parts without prior notice.

Important: No Liability is accepted for incorrect use of this product.

Warranty: Guarantee is 12 months from purchase date, proof of which is required for any claim.

Sealey Group, Kempson Way, Suffolk Business Park, Bury St Edmunds, Suffolk. IP32 7AR



01284 757500



01284 703534



sales@sealey.co.uk



www.sealey.co.uk