



PREMIER HYDRAULIC PRESS 20 & 30 TONNE FLOOR TYPES

MODEL NO: PPF20 / PPF30

Thank you for purchasing a Sealey product. Manufactured to a high standard, this product will, if used according to these instructions, and properly maintained, give you years of trouble free performance.

IMPORTANT: PLEASE READ THESE INSTRUCTIONS CAREFULLY. NOTE THE SAFE OPERATIONAL REQUIREMENTS, WARNINGS & CAUTIONS. USE THE PRODUCT CORRECTLY AND WITH CARE FOR THE PURPOSE FOR WHICH IT IS INTENDED. FAILURE TO DO SO MAY CAUSE DAMAGE AND/OR PERSONAL INJURY AND WILL INVALIDATE THE WARRANTY. KEEP THESE INSTRUCTIONS SAFE FOR FUTURE USE.



Refer to instructions



Wear eye protection

1. SAFETY

- ✓ Familiarise yourself with the applications, limitations and hazards of the press.
- ✓ Maintain the press in good condition (use an authorised service agent).
- ✓ Replace or repair damaged parts. *Use recommended parts only. Unauthorised parts may be dangerous and will invalidate the warranty.*
- ✓ Keep the press clean for best and safest performance.
- ✓ Locate the press in a suitable work area, on a surface that is stable, level, dry, not slippery, and capable of sustaining the load.
- ✓ Keep area clean and tidy and free from unrelated materials, and ensure there is adequate lighting.
- WARNING!** Always wear approved eye or face protection when operating the press.
- ✓ Remove ill fitting clothing. Remove ties, watches, rings and other loose jewellery, and contain long hair.
- ✓ Keep hands and body clear of the work table when operating the press.
- ✓ Maintain correct balance and footing. **DO NOT** over reach. Ensure the floor is not slippery and wear non-slip shoes.
- ✓ Keep children and unauthorised persons away from the working area.
- * **DO NOT** use the press for a task it is not designed to perform.
- * **DO NOT** adjust or tamper with the safety valve, or make any modifications to the press.
- * **DO NOT** exceed the rated capacity of the press. Avoid applying excessive force, use the pressure gauge to determine the applied load.
- * **DO NOT** apply off-centre loads. Ensure that workpiece is centrally loaded and correctly secured before operating the press.
- * **DO NOT** allow the workpiece or the arbor plates to fall from the press work bench.
- * **DO NOT** get the press wet or use in damp or wet locations or areas where there is condensation.
- * **DO NOT** operate the press when you are tired or under the influence of alcohol, drugs or intoxicating medication.
- * **DO NOT** climb upon the press.
- * **DO NOT** use if bent, broken, cracked, leaking or otherwise damaged, or if press has been subjected to a shock load.
- * **DO NOT** operate the press if any parts are missing as this may cause failure and/or possible personal injury.
- * **DO NOT** use the press to compress a spring or any other item that could disengage and cause a potential hazard.
- * **DO NOT** stand directly in front of loaded press and never leave loaded press unattended.
- * **DO NOT** allow untrained persons to operate the press.
- ▲ **DANGER!** This model is purpose designed to withstand greater loads than the hydraulic unit can develop. For safety reasons, always ensure the workpiece and press tools are secured on the table and will not flex or suddenly give way, causing danger to operator or the workpiece.
- WARNING! DO NOT use brake fluid, or any fluid other than a good quality jack oil, such as SEALEY HYDRAULIC JACK OIL, as this may cause serious damage to the press and will invalidate the warranty.**
- ✓ When not in use, release pressure from the pump and clean the press. Stand or store the arbors in a safe, childproof location.

2. INTRODUCTION

Manufactured in Europe, a Professional range of floor and bench mount presses, ranging from 15tonne to 50tonne. Hydraulic elements are mounted in the frame to maximise workspace and protect components. Floor models incorporate a fast approach feature (foot pedal or handle operated depending on model). Model No's PPF301 and PPF501 are air/hydraulic and fully operated by foot pedal to keep hands free for fine positioning of the workpiece. Storage for press pins included in frame (pins not included on Model No's PPB15, PPF20 and PPF30). Suitable for workshop use or by the serious motoring enthusiast.

3. SPECIFICATION

Model No:	PPF20	PPF30
Capacity:	20tonne	30tonne
Ram Stroke:	195mm	195mm
Ram Diameter:	51mm	58mm
Maximum Height - Ram to Table:	858mm	854mm
Minimum Height - Ram to Table:	21mm	17mm
Table Aperture:	148mm	148mm
Working Table Depth:	172mm	172mm
Working Table Width:	670mm	670mm
Overall Height:	1850mm	1850mm
Gauge Included:	Yes	Yes
Nett Weight:	106kg	123kg

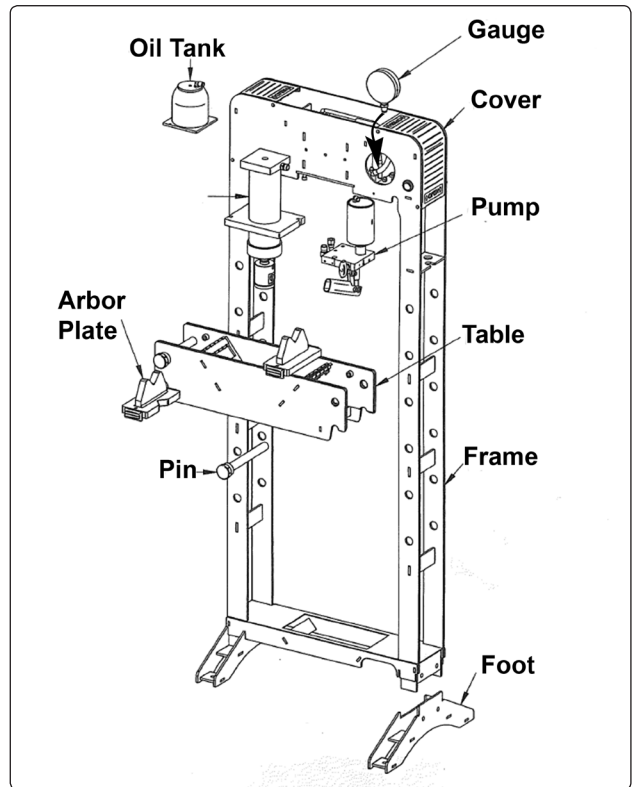
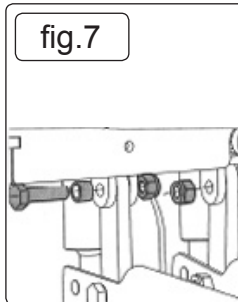
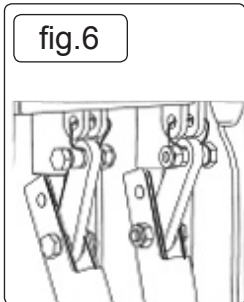
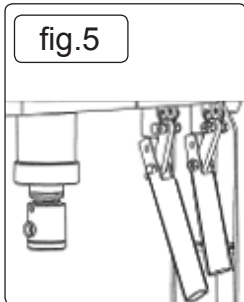
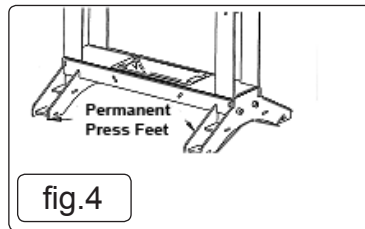
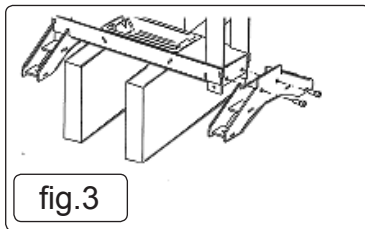
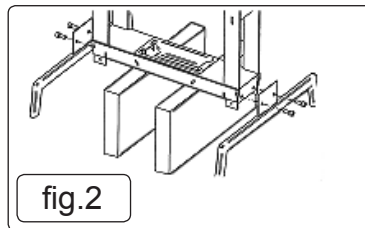
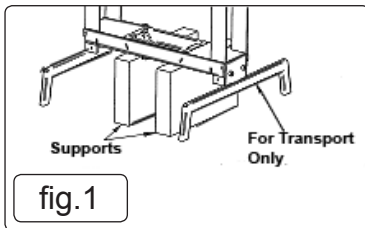

4. ASSEMBLY

❑ **WARNING!** these presses are heavy, the use of a lifting appliance is recommended.

4.1. FITTING THE FEET

- 4.1.1. Lift the press onto suitable, safe supports (fig.1).
- 4.1.2. Remove the transport feet (fig.2), ensuring the stability of the press frame.
- 4.1.3. Replace with the permanent press feet (figs.3 & 4).
- 4.1.4. It is recommended that, for safest operation, the press is secured to the floor using the fixing holes in the feet.

4.2. FITTING THE PUMP HANDLES

- 4.2.1. The press is supplied with the pump handles disconnected, to save damage in transit (fig.5).
- 4.2.2. Cut the plastic ties to release the pump handles (fig.6).
- 4.2.3. Fix pump handle by means of screw, guide bush and nut (fig.7).
- 4.2.4. Fit the long pump handle into the socket of high speed pump (fig.8).

5. OPERATION

5.1. BLEEDING THE HYDRAULIC CIRCUIT

- 5.1.1. Before first use, any air trapped in the hydraulic circuit will need to be bled.
- 5.1.2. To do this: open the release valve and pump both pumps 10 times.
- 5.1.3. Close the release valve and pump a further 10 times. The ram should extend.
- 5.1.4. Open the release valve again; the ram should retract.
- 5.1.5. If the hydraulic circuit still appears sluggish, repeat the process.

5.2. USING THE PRESS

- 5.2.1. Insert the saddle into the ram head and secure with the grub screw (fig.9).
- 5.2.2. Lift or lower the table to the required height and insert the pins to support it.
- 5.2.3. Place the arbor plate on the press bed frame, then place workpiece onto the arbor plate and align beneath the ram as required.
NOTE: care must be taken to ensure an arbor does not fall from the press work table. If necessary, fix in position.
- 5.2.4. Close the release valve by turning it clockwise fully.
- 5.2.5. Pump with the high speed pump until the saddle is close to the workpiece.
- 5.2.6. Use the low speed pump to perform the pressing operation, monitoring the pressure via the pressure gauge. Using this pump allows greater control and feel.
- 5.2.7. When the operation is finished, release the pressure gradually by opening the release valve slowly.
- 5.2.8. When the ram has retracted fully, remove the work from the table.
- 5.2.9. When the press is not in use, ensure that the ram is retracted fully to help avoid corrosion.

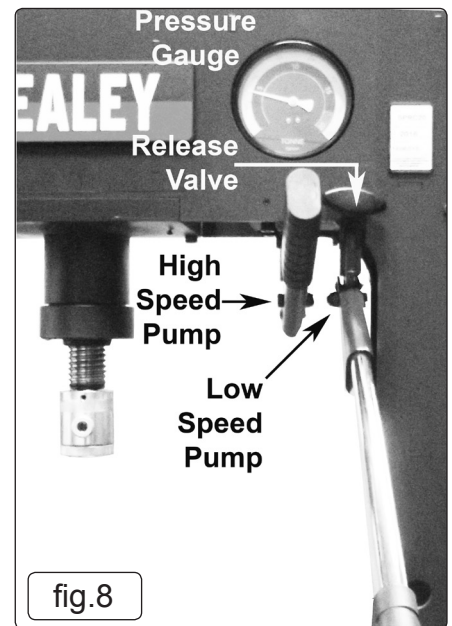

fig.8

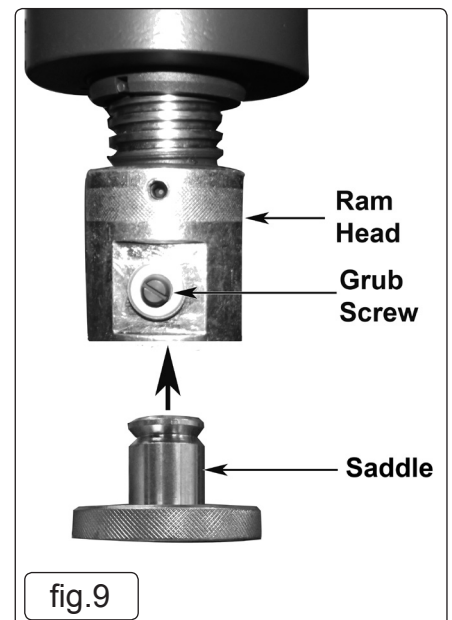

fig.9

6. MAINTENANCE

NOTE: Maintenance and repair must only be carried out by a qualified person. Contact your Sealey stockist for details.

- 6.1. Lubricate all joints and moving parts periodically.
- 6.2. Always keep the press clean, dry and protected from harsh conditions.
- 6.3. To check hydraulic oil level, open the left hand top cover, and unscrew the oil filler screw (fig.10). If oil needs replacing, use only Sealey hydraulic jack oil. **DO NOT** use brake fluid. Contact your local Sealey stockist for details). Replace oil filler screw and purge system of air.
- 6.4. When replacing the hydraulic oil, ensure the piston is fully retracted.
- 6.5. If press efficiency begins to drop, purge the system to eliminate any air from the hydraulic system (see 5.1.).
- 6.6. When not in use, clean the press with a damp, soapy cloth. **DO NOT** use abrasive or solvent cleaners.

IMPORTANT! Owing to their size and weight, hydraulic products should ideally be repaired by local service agents. We have service / repair agents in most parts of the UK. Before returning your product please call our technical helpline on **01284 757505** for advice and trouble shooting guidance.

If the product is under guarantee please contact your Sealey stockist.

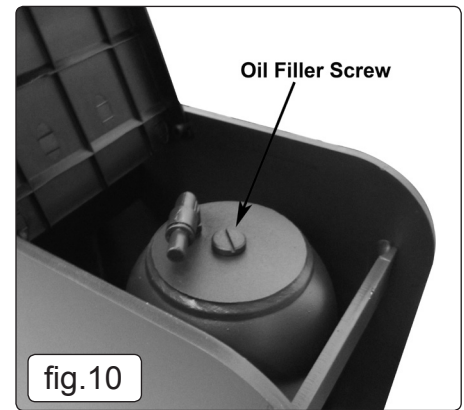

ENVIRONMENT PROTECTION

Recycle unwanted materials instead of disposing of them as waste. All tools, accessories and packaging should be sorted, taken to a recycling centre and disposed of in a manner which is compatible with the environment. When the product becomes completely unserviceable and requires disposal, drain any fluids (if applicable) into approved containers and dispose of the product and fluids according to local regulations.

Note: It is our policy to continually improve products and as such we reserve the right to alter data, specifications and component parts without prior notice.

Important: No Liability is accepted for incorrect use of this product.

Warranty: Guarantee is 12 months from purchase date, proof of which is required for any claim.

Sealey Group, Kempson Way, Suffolk Business Park, Bury St Edmunds, Suffolk. IP32 7AR



01284 757500



01284 703534



sales@sealey.co.uk



www.sealey.co.uk