

Thank you for purchasing a Sealey plasma cutter. Manufactured to a high standard this product will, if used according to these instructions and properly maintained, give you years of trouble free performance.



IMPORTANT: BEFORE USING THIS PRODUCT, PLEASE READ THE INSTRUCTIONS CAREFULLY. MAKE CAREFUL NOTE OF SAFETY INSTRUCTIONS, WARNINGS AND CAUTIONS. THIS PRODUCT SHOULD ONLY BE USED FOR ITS INTENDED PURPOSE. FAILURE TO DO SO MAY CAUSE DAMAGE AND/OR PERSONAL INJURY AND WILL INVALIDATE THE WARRANTY. RETAIN THESE INSTRUCTIONS FOR FUTURE USE.

1. INTRODUCTION & SPECIFICATION

The PP35 is an inverter power supply fitted with plasma cutter control circuitry. Features include an LED information panel covering torch under voltage, air fault, general fault (thermostat, over/under voltage, over current) and power on. The plasma inverter is suitable for cutting steel, stainless steel, aluminium, copper and brass and includes an integrated air filter, regulator and pressure gauge.

When the torch trigger is depressed a pilot arc is initiated within the torch which then transfers to the workpiece. The combination of the electrical arc and the fast flowing air generates a plasma (*very hot gas*) jet which cuts the workpiece.

Specification

Duty Cycle	.30% @ 40A 100% @ 22A
Air Flow	.100ltr/min
Air Pressure	.4-5 bar (55-70psi)
Supply	.230V - 1ph 30A
Power Absorbed	.4.6kW
Supply Fuse (Delayed)	.20A
Insulation Class	.H
Protection	.IP23

No Load Voltage	.406V
Cutting Current	.15-40A
Max. Cutting Capacity (Carbon Steel)	.12mm
Weight	.12kg

Torch

Gas	.Dry compressed air
Air Pressure	.4-5 bar (55-70psi)
Cooling Flow Rate	.100ltr/min
Striking System	.Pilot Arc
Cutting Current	.15-40A

2. SAFETY INSTRUCTIONS

2.1. ELECTRICAL SAFETY

- WARNING! Electrical installation of the plasma cutting unit must be carried out by a qualified electrician. Make sure that power supply cable is correctly connected to earth. It is the owner's responsibility to read, understand and comply with the following:**

You must check all electrical equipment and appliances to ensure that they are safe before using. You must inspect power supply leads, plugs and all electrical connections for wear and damage. You must ensure that the risk of electric shock is minimised by the installation of appropriate safety devices. An RCCB (Residual Current Circuit Breaker) should be incorporated in the main distribution board. We also recommend that an RCD (Residual Current Device) is used with all electrical products. It is particularly important to use an RCD with portable products that are plugged into an electrical supply not protected by an RCCB. If in doubt consult a qualified electrician. You may obtain a Residual Current Device by contacting your Sealey dealer. **You must** also read and understand the following instructions concerning electrical safety.

- 2.1.1. The **Electricity At Work Act 1989** requires all portable electrical appliances, if used on business premises, to be tested by a qualified electrician, using a Portable Appliance Tester (PAT), at least once a year.
- 2.1.2. The **Health & Safety at Work Act 1974** makes owners of electrical appliances responsible for the safe condition of the appliance and the safety of the appliance operator. **If in any doubt about electrical safety, contact a qualified electrician.**
- 2.1.3. Ensure that the insulation on all cables and the product itself is safe before connecting to the mains power supply. See 2.1.1. & 2.1.2. above and use a Portable Appliance Tester.
- 2.1.4. Ensure that cables are always protected against short circuit and overload.
- 2.1.5. Regularly inspect power supply, leads, plugs and all electrical connections for wear or damage and check power connections, to ensure that none is loose.
- 2.1.6. **Important:** Ensure that the voltage marked on the product is the same as the power supply to be used and that the supply is adequately protected. See Supply Fuse, Section 1.
- 2.1.7. DO NOT pull or carry the cutter by the power supply lead or the output cables.
- 2.1.8. DO NOT pull plugs from sockets by the cable.
- 2.1.9. DO NOT use worn or damage leads, plugs or connections. Immediately replace or have repaired by a qualified electrician.
- 2.1.10. DO NOT use this product with a cable extension reel.

- 2.1.11. **This product will require MORE than a 13 amp electrical supply, so no plug is fitted. You must contact a qualified electrician to ensure that a 30 amp supply is available. We recommend you discuss the installation of a industrial round pin plug and socket with your electrician.**

- WARNING! Reminder, the electrical installation of the plasma cutting unit must only be carried out by a qualified electrician.**
- WARNING! Be very cautious if using a generator to power the inverter. The generator must be self regulating and stable with regard to voltage, waveform and frequency. The output must be greater than the power consumption of the inverter. If any of these requirements is not met the electronics within the inverter may be affected.**

NOTE:The use of an unregulated generator may be dangerous and will invalidate the warranty.

- WARNING! The inverter may produce voltage surges in the mains supply which can damage other sensitive equipment (e.g. computers). To avoid this happening it is recommended that the inverter is connected to a power supply that does not feed any sensitive equipment.**

**230V 1ph
THE PLASMA CUTTER
MUST BE CONNECTED
TO A
30 AMP SUPPLY**

2.2. GENERAL SAFETY

- ▲ **DANGER!** Direct contact with the plasma cutter circuit or torch is dangerous. You **MUST** unplug the cutter from the mains power supply, (and the compressed air supply) before connecting or disconnecting cables or performing maintenance or service.
- ✓ Keep the plasma cutter, cables and torch in good condition. Take immediate action to repair or replace damaged parts.
- ✓ Use recommended parts and accessories only. Unapproved parts may be dangerous and will invalidate the warranty.
- ✓ Only use the cutting torch provided and ensure that any replacement is of the same type.
- ✓ Use the plasma cutter in a suitable work area. Ensure that the area has adequate ventilation as cutting fumes are harmful. For enclosed areas we recommend the use of an air and smoke extraction system. If you are not able to provide adequate extraction and/or ventilation, wear a respirator suitable for protection against toxic fumes, smoke and gases.
- ✓ Ensure that there are no obstructions to the flow of clean cool air and ensure that there are no conductive dusts, corrosive vapours or humidity which could enter the unit and cause serious damage.
- ❑ **WARNING:** Use a welding head shield to protect your eyes and avoid exposing skin to the ultraviolet rays given off by the electric arc. Always wear protective clothing, insulating gloves and shoes. Keep all protective items clean and undamaged.
- ✓ Remove ill fitting clothing before wearing protective clothing. Also remove ties, watches, rings and other loose jewellery and contain long hair.
- ✓ Stand correctly, keeping a good footing and balance and ensure that the floor is not slippery. Wear non-slip shoes.
- ✓ Ensure that the workpiece is correctly secured before cutting.
- ✓ Avoid unintentional contact with the workpiece. Accidental or uncontrolled switching on of the torch may be dangerous and will wear the nozzle.
- ✓ Keep unauthorised persons away from the work area. Any persons working within the area must wear the same protective items as the operator.
- x DO NOT use cables and torch if the insulation is worn or connections are loose.
- x DO NOT attempt to fit any unauthorised torch or other component to the plasma cutting unit.
- x DO NOT cut surfaces that are painted, galvanic coated, oily or greasy.
- x DO NOT use cables over 10m in length.
- x DO NOT connect the return cable to any structure which is not part of the workpiece (other than a metal work bench supporting the workpiece).
- ▲ **DANGER!** DO NOT cut near flammable materials - solids, liquids, or gases. Remove all flammable materials such as waste rags etc.
- x DO NOT cut containers or pipes which have held flammable materials - gases, liquids or solids. DO NOT cut materials that have been cleaned with chlorinated solvents (or near such solvents) as vapours from the arc action may produce toxic gases.
- x DO NOT operate the cutter while under the influence of drugs, alcohol or intoxicating medication, or if tired.
- x DO NOT use the plasma cutter for a task it is not designed to perform.
- x DO NOT operate the plasma cutter if any parts are damaged or missing as this may cause failure and/or personal injury.
- x DO NOT carry, or pull, the cutter by the leads or cables. DO NOT strain or bend the cables, protect them from sharp or abrasive items and DO NOT stand on them.
- ✓ Protect cables from heat. Long lengths of slack must be gathered and neatly coiled. DO NOT place cables where they will endanger others.
- x DO NOT hold unsecured workpiece in your hand.
- x DO NOT get the plasma cutter wet or use in damp or wet locations or areas where there is condensation.
- x DO NOT touch the workpiece close to the cut as it will be very hot. Allow to cool. The cut edge of the workpiece will also be very sharp.
- x DO NOT touch the torch immediately after use. Allow the torch to cool.
- ✓ When not in use store the unit in a safe, dry, childproof area.

2.3. AIR SUPPLY GENERAL SAFETY

- ❑ **WARNING!** Turn off the air supply and de-pressurise the air line before disconnecting from the cutter. Failure to comply with this instruction may damage the unit and will invalidate your warranty.
- ❑ **WARNING!** Ensure that correct air pressure is maintained and not exceeded. Recommended pressure 4-5 bar (55-70psi), required air flow 100ltr/min.
- ❑ **WARNING!** DO NOT exceed maximum entry pressure of 8 bar. Excessive pressure may cause damage and/or personal injury.
- ✓ Keep air hose away from heat, oil and sharp edges. Check air hose for wear before each use, and ensure that all connections are secure.
- x DO NOT carry the cutter by the hose, or yank the hose from the air supply, and DO NOT direct air from the air hose at yourself or others.

3. CARRY STRAP ASSEMBLY

If not already fitted, route the carry strap as shown.

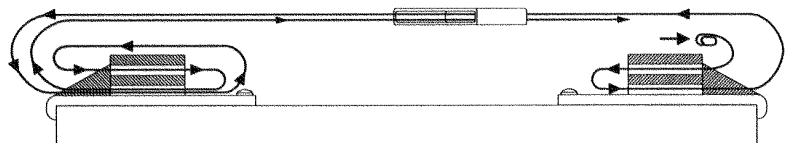

4. AIR SUPPLY

- ❑ **WARNING!** Ensure you have read and understood the safety instructions in 2.3. before connecting or operating the air supply.
- 4.1. An external compressed air supply must be attached to the PP35 plasma cutter. The supply must produce 4-5 bar with a delivery of 100 ltr/min. Note that the maximum pressure **must not** exceed 8 bar.
- 4.2. To avoid excessive wear of the cutter ensure that the air supply is clean and free from moisture. We recommend connection to a clean air system as shown in fig. 1.
- 4.3. The compressor air inlet filter should be cleaned weekly.
- 4.4. Line pressure should be increased to compensate for unusually long air hoses (over 8 metres). The minimum hose bore should be 10mm and fittings must have the same inside diameter.
- 4.5. Keep hose away from heat, oil and sharp edges. Check hoses for wear and make certain that all connections are secure.

Note: DO NOT use an oiler in the air system, the air must remain **DRY** at all times.

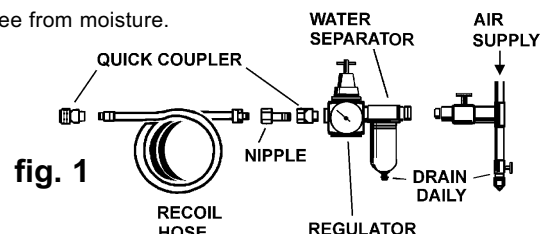

5. CONTROL INSTRUCTIONS

- **WARNING!** Before operating the machine ensure that you read, understand and apply Section 2 safety instructions. Ensure that the machine is disconnected from the power supply before moving or changing accessories.

5.1. Locating the cutter

- 5.1.1. Ensure that the work area has a good airflow and that there is no dust, smoke or gas present.
 5.1.2. Ensure that there is a minimum clearance of 500mm around the machine, and that there are no obstacles to prevent a cool airflow. Also check to ensure that the front outlet and rear grills are not blocked.
 5.1.3. When moving the machine, disconnect from the mains power supply and gather all cables safely.

5.2. Connecting the earth cable

- 5.2.1. Insert the male connector of the earth cable into the connector (fig. 2.10) on the lower front panel of the machine and twist to retain.
 5.2.2. Connect the work clamp to the workpiece or to the metal workbench as follows:
 1. Check that there is a good electrical contact. Caution: Ensure that you have made good contact on oxidised or coated sheets.
 2. Make the earth connection as close to the cutting area as possible.
 3. DO NOT connect to structures or objects, other than the metal workbench which is supporting the workpiece. To do so may damage the safety system and will give a poor cut.
 4 DO NOT make the earth connection to the part of the workpiece that will be removed.

5.3. ON/OFF switch

The on/off switch is located at the rear of the machine (fig. 2.1). When the switch is in the "O" position the machine is turned off. When switched to the "I" position the machine is turned on and the switch will illuminate. A green LED (fig. 2.9) will also show on the front panel indicating that mains power is present and the machine is in the 'ready' condition. The control and duty circuits are now live but the torch will remain in 'stand-by' mode until the torch button is pressed.

5.4. Cutting regulator

The cutting current is regulated by the knob/potentiometer on the front panel (fig. 2.2).

5.5. Air pressure

- 5.5.1. Unlock the pressure regulator knob (fig. 2.3) by pulling it upwards. Adjust the regulator to give the required air pressure (see 6.1.5 & 6). Always adjust **up** to the required pressure.
 5.5.2. Push the pressure regulator knob downwards to lock it. If the air pressure is too low the cutter will shut down and the amber LED (fig. 2.6) and the red LED (fig. 2.7) will illuminate. The LEDs will go out and the cutter will reset as soon as the air pressure is adjusted.

5.6. Torch control

When the machine is turned on the green indicator light (fig. 2.9) will show that the torch is in "Stand-By" mode.

- 5.6.1. When the torch button is pressed the machine is activated and a yellow LED will illuminate (fig. 2.5) indicating the presence of the pilot arc. As a safety feature, should the following situations arise the torch will automatically de-activate:
 a) During Post-Air (>30sec) phase.
 b) If the pilot arc is not moved to the workpiece within 2 seconds.
 c) If the cutting arc is interrupted because the torch is held too far from the workpiece, or if the electrode is worn out, or if the torch has been forced away from the workpiece.
 d) If the warning LED illuminates indicating either mains voltage fluctuation or overheating.

5.7. Thermal or mains voltage fault

If the yellow LED (fig. 2.6) on the front panel illuminates (without the red LED) this indicates a mains voltage or thermal problem and the machine will be automatically shut down as a result of one of the following :
 a) The power transformer has overheated.
 b) There has been a decrease or increase in the mains voltage supplied to the machine.

When the safety cut-out is activated in this way the problem is normally self-rectifying, and within a few seconds the switch will re-set and the LED will go out. The machine is then ready for use again.

5.8. Torch

Although the machine and torch may be fully powered, the torch button is the only way to activate the cutting process.

- 5.8.1. To turn the cutting process on, the torch button must be fully depressed.
 5.8.2. Release the button and the cutting cycle will stop immediately. The cooling air (post-air) will continue to flow for a further 30 seconds.

Note: To minimise the possibility of accidental starting, the button must be pressed for at least half a second before the cutting operation will start.

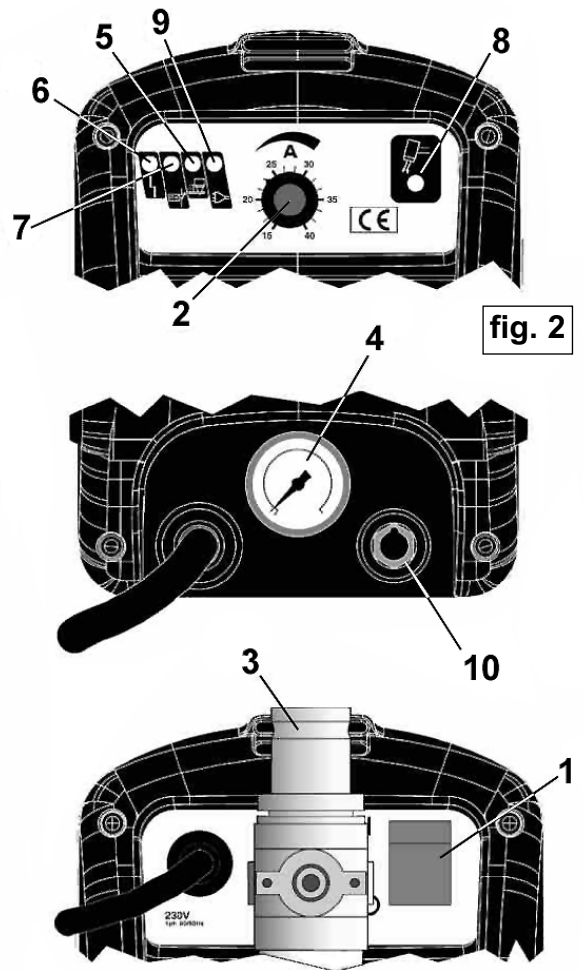

6. OPERATING INSTRUCTIONS

- **WARNING!** Before operating the machine ensure that you read, understand and apply Section 2 safety instructions and that you have familiarised yourself with the controls. Ensure that the machine is disconnected from the power supply before moving or changing accessories.

6.1. Set-up

- 6.1.1. Ensure that the compressed air is connected correctly to the machine (see Section 4).
- 6.1.2. Check that the earth cable is correctly clamped to the workpiece or work bench (see 5.2).
- 6.1.3. Switch on the mains power supply. Switch on the machine by operating the switch on the rear panel (fig. 2.1).
- 6.1.4. Set the current regulation control (fig. 2.2) to the required value.
- 6.1.5. Press the torch button and release to commence the flow of cooling air (post-air).
- 6.1.6. Set the air pressure and check that the air gauge (fig. 2.4) indicates the correct value (see 5.6).
- 6.1.7. Allow the air flow to continue to remove any condensation from the torch. The air flow will automatically stop after approx. 30secs.

NOTE: Longer than standard nozzles and electrodes are available for the torch to improve accessibility in awkward cutting positions.

6.2. Cutting from the edge

The torch provided with this unit should make contact with the material to be cut (touch-cut).

- 6.2.1. Bring the torch nozzle toward the edge of workpiece and hold it at 3mm above the cutting line.
- 6.2.2. Press and hold down the torch button. After about 0.5secs of pre-air the pilot arc will be generated. If the distance between the torch nozzle and the workpiece is correct, the arc will immediately jump to the workpiece and the cutting process will begin.
- 6.2.3. Move the torch slowly and smoothly forward, on the surface of the workpiece, along the cutting line.
- 6.2.4. Adjust the cutting speed according to the thickness of the material and the selected current.
- 6.2.5. Check the underside of the cut. The arc should make a 5 - 10° angle with the vertical in the opposite direction to the cutting direction (fig. 3).

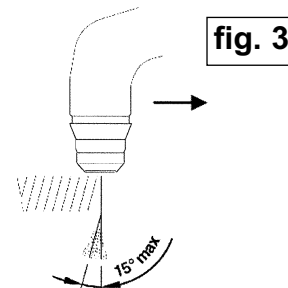

6.3. Cutting from the centre

- 6.3.1. Place torch nozzle at an angle to the surface at the start-of-cut position (fig. 4).
- 6.3.2. Initiate the pilot arc, then slowly and smoothly bring the torch head to the upright position. The arc will pierce the workpiece and cutting can start.

6.4. Arc off

- 6.4.1. Release the torch button to switch off the arc. The post-air will continue to flow, cooling the nozzle.
- 6.4.2. Other reasons for the arc ceasing are:
 - a) The distance between the torch nozzle and workpiece is too great.
 - b) You have completed a cut and have continued beyond the edge of a workpiece.
 - c) The waste falls away from the workpiece thus increasing the gap.

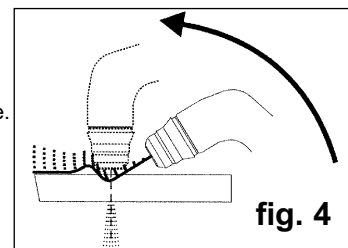

7. MAINTENANCE

- ▲ **DANGER!** Ensure that the machine is disconnected from the power supply before performing service or maintenance on any part of the unit, cables or torch.

7.1. The inverter

DO NOT open the unit. Service and maintenance of the machine may only be undertaken by an authorised service agent.

- 7.1.1. Keep the machine clean by wiping with a soft cloth. Do not use abrasives.
- 7.1.2. Periodically check to ensure that the carrying handle is in good order and condition. If not replace it immediately.
- 7.1.3. Ensure that the front and rear air vents are not blocked.

7.2. Cables and leads

- 7.2.1. Check to ensure cables and leads are in good condition. If damaged, contact your authorised service agent.
- 7.2.2. Keep cables and leads clean. Do not use solvents.

7.3. Torch

Check torch regularly. Maintenance will depend on frequency and type of usage and is essential for correct and safe use of the torch.

- **WARNING!** Ensure that the torch is cool before attempting any maintenance. Always re-assemble the torch in the correct order as shown in fig. 5. Never use tools to tighten nozzle components, hand tighten only. Manually dismantle the torch nozzle head (fig. 5). Items 2 and 4 show standard and optional electrodes and nozzles.

- 7.3.1. **Cap** (fig. 5.1). Clean cap and check to ensure it is not damaged (including distortion, burns, cracks). If in any doubt, replace.

- 7.3.2. **Electrode** (fig. 5.2).

Check the build-up on the emitting surface of the electrode. When the build-up is approximately 2mm replace the electrode.

NOTE: We recommend that the electrode and nozzle are changed at the same time.

- 7.3.3. **Air distribution ring** (fig. 5.3).

Check that the ring is not burned or cracked and that the airflow holes are not obstructed. If damaged, replace.

- 7.3.4. **Nozzle** (fig. 5.4).

If surface is oxidised clean it with extra fine abrasive paper. Check wear of the plasma arc hole and the inner and outer surfaces. If hole has widened, or nozzle is damaged in any way, replace it. The nozzle "V" crater should be 1.5mm in depth (fig. 6).

7.4. Compressed air filter

The filter, beneath the regulator (fig. 2.3), removes condensation from the air system, and must be kept clean.

- 7.4.1. Regularly inspect the filter. If the glass bowl contains water, drain by pushing the drain plug upwards.
- 7.4.2. When the filter cartridge becomes dirty, replace it.
- 7.4.3. Clean the filter bowl with soapy water only. Do not use abrasives or solvents.

fig. 5

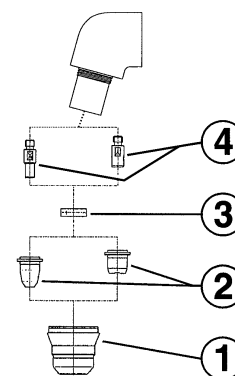
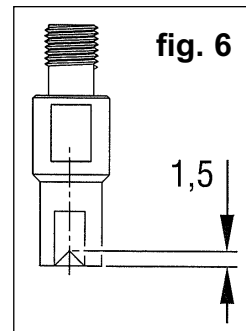

fig. 6



8. TROUBLESHOOTING

PROBLEM	POSSIBLE CAUSE	REMEDY
Insufficient penetration or excessive scoria settlement.	Too high a cutting speed. Torch is too tilted. Workpiece is too thick. Electrode and nozzle are worn out.	Slow the cutting speed. Adjust the torch tilt. Confirm workpiece thickness and re-check technical data. Replace electrode and nozzle.
Interruption of cutting arc.	Cutting speed too low. Excessive distance between torch and workpiece. Electrode is worn out. Intervention of the protection system.	Increase cutting speed. Decrease the distance between torch and workpiece. Replace electrode and nozzle. Check warning lights and take appropriate action.
The torch is cutting at tilt when you wish it to be perpendicular.	Torch position not correct. Asymmetric wear of nozzle hole and/or wrong assembly of torch parts.	Re-align the torch. Check assembly (see fig. 5) and change nozzle if necessary.
Excessive wear of nozzle and electrode.	Air pressure too low. Contaminated air (humidity-oil). Excessive pilot arc ignitions in the air. Nozzle holder damaged.	Increase air pressure (see para. 5.6). Check air supply system (see Sections 4, 5 & 7). Do not casually turn the torch on and off. Change the nozzle holder.

9. RATING PLATE

On the rear of the inverter is the rating plate, giving the following data:

- 1 - U_0 : Maximum open-circuit voltage.
- 2 - I_2 , U_2 : Current and corresponding voltage.
- 3 - X: Duty cycle, based on a 10 minute period. 30% indicates 3 minutes cutting and 7 minutes rest, 100% indicates continuous cutting.
- 4 - Power Supply: AC, number of phases and frequency.
- 5 - U_1 : Rated supply voltage.
- 6 - I_{1max} : Maximum RMS current absorbed. I_{1eff} : Nominal RMS current absorbed.
- 7 - Rating of internal protection provided by casing.
- 8 - S: Indicates that cutting may be carried out in environments with a heightened risk of electric shock e.g. very close to large metallic objects.
- 9 - Symbol for type of process.
- 10 - Inverter-transformer-rectifier.
- 11 - The standard relating to the safety and construction of welding and cutting equipment.
- 12 - Equipment model number.
- 13 - AV-A/V: Cutting current range and corresponding voltages.
- 14 - Serial Number. Specifically identifies each inverter.
- 15 - Rating of delayed action fuse for supply protection.
- 16 - Symbols referring to safety.

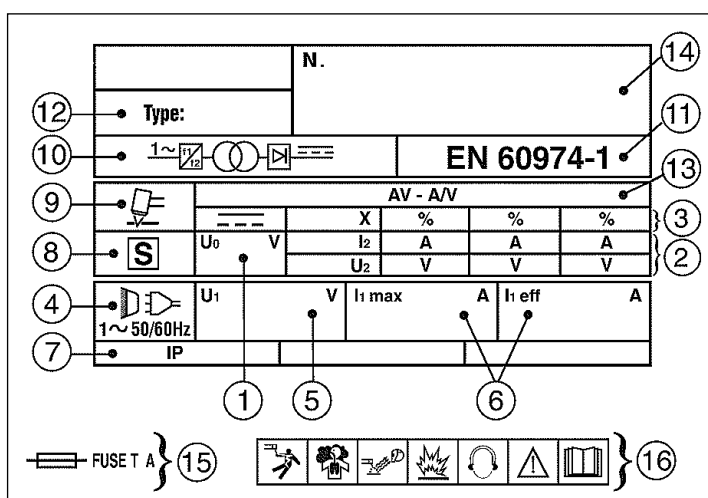

10. ELECTROMAGNETIC COMPATIBILITY

- 10.1. THIS EQUIPMENT IS IN CONFORMITY WITH THE EUROPEAN STANDARD ON THE ELECTROMAGNETIC COMPATIBILITY OF ARC WELDING EQUIPMENT AND SIMILAR PROCESSES (e.g. ARC AND PLASMA CUTTING)
- 10.2. **Protection against interference. (E.M.C.)** The emission limits in this standard may not, however, provide full protection against interference to radio and television reception when the equipment is used closer than 30m to the receiving antenna. In special cases, when highly susceptible apparatus is being used in close proximity, additional mitigation measures may have to be employed in order to reduce the electromagnetic emissions. At the same time there could occur some potential difficulties in having electromagnetic compatibility in a non-industrial environment (e.g. in residential areas). Therefore it is most important that the equipment is used and installed according to the following instructions.
- 10.3. **Installation and use.** The user is responsible for installing and using the equipment according to these instructions. If electromagnetic disturbances are detected, then it shall be the responsibility of the user of the equipment to resolve the situation with the technical assistance of the supplier. In some cases this remedial action may be as simple as earthing the circuit (see Note). In other cases it could involve constructing an electromagnetic screen, enclosing the welding power source and the work, complete with associated input filters. In all cases the electromagnetic disturbances shall be reduced to the point where they are no longer troublesome.
Note: The welding/cutting circuit may or may not be earthed for safety reasons. Changing the earthing arrangements should only be authorised by a person who is competent to assess whether the changes will increase the risk of injury, e.g. by allowing parallel welding/cutting circuit return paths which may damage the earth circuits of other equipment. Further guidance is given in IEC 974-13 'Arc Welding Equipment - Installation and Use.'
- 10.4. **Assessment of area.** Before installing the equipment the user shall make an assessment of potential electromechanical problems in the surrounding area. The size of the surrounding area to be considered will depend on the structure of the building and other activities that are taking place. The surrounding area may extend beyond the boundaries of the premises.
The following shall be taken into account :
 - a) Other supply cables, control cables, signalling and telephone cables, above, below and adjacent to the welding equipment.
 - b) Radio and television transmitters and receivers.
 - c) Computer and other control equipment.
 - d) Safety critical equipment, e.g. security monitoring of industrial equipment.
 - e) The health of people in the vicinity, e.g. persons fitted with a pacemaker or hearing aid.
 - f) Equipment used for calibration or measurement.
 - g) The immunity of other equipment in the environment. The user shall ensure that other equipment being used in the environment is compatible. This may require additional protective measures.
 - h) The time of day that welding and other activities are to be carried out.

- 10.5. **Mains supply.** The equipment should be connected to the mains supply according to these instructions. If interference occurs, it may be necessary to take additional precautions such as filtering of the mains supply. Consideration should also be given to shielding the supply cable of permanently installed equipment in metallic conduit or equivalent. This shielding should be connected to the power source so that good electrical contact is maintained between the conduit and the welding power source enclosure.
- 10.6. **Maintenance of the equipment.** The equipment should be routinely maintained according to these instructions. All access and service covers should be closed and properly fastened when the welding equipment is in operation. The welding equipment should not be modified in any way except for those changes and adjustments covered in these instructions. In particular, the spark gaps of any arc striking and stabilising devices should be adjusted and maintained according to the instructions.
- 10.7. **Cables.** The welding/cutting cables should be kept as short as possible and should be positioned close together, running at or close to the floor level.
- 10.8. **Equipotential bonding.** Bonding of all metallic components in the welding/cutting installation and adjacent to it should be considered. However, metallic components bonded to the workpiece will increase the risk that the operator could receive a shock by touching these metallic components and the electrode at the same time. The operator should be insulated from all such bonded metallic components.
- 10.9. **Earthing of the workpiece.** Where the workpiece is not bonded to earth for electrical safety, nor connected to earth because of its size and position, e.g. ship's hull or building steelwork, a connection bonding the workpiece to earth may reduce emissions in some, but not all instances. Care should be taken to prevent the earthing of the workpiece increasing the risk of injury to others or damage to other electrical equipment. Where necessary, the connection of the workpiece to earth should be made by a direct connection to the workpiece, but in some countries where direct connection is not permitted, the bonding should be achieved by a suitable capacitance, selected according to national regulations.
- 10.10. **Screening and shielding.** Selective screening and shielding of other cables and equipment in the surrounding area may alleviate problems of interference. Screening of the entire welding/cutting installation may be considered for special applications.

11. DECLARATION OF CONFORMITY

Declaration of Conformity We, the sole importer into the UK, declare that the product listed below is in conformity with the following standards and directives.

PLASMA CUTTER

Model: PP35

73/23/EEC Low Voltage Directive

89/336/EEC EMC Directive

93/68/EEC CE Marking Directive



The construction file for this product is held by the Manufacturer and may be inspected, by a national authority, upon request to Jack Sealey Ltd.

Signed by Mark Sweetman

15th April 2003

For Jack Sealey Ltd. Sole importer into the UK of Sealey Power Welders.

NOTE: It is our policy to continually improve products and as such we reserve the right to alter data, specifications and component parts without prior notice.

IMPORTANT: No liability is accepted for incorrect use of this equipment.

WARRANTY: Guarantee is 12 months from purchase date, proof of which will be required for any claim.

INFORMATION: For a copy of our latest catalogue and promotions call us on 01284 757525 and leave your full name and address, including postcode.



**Sole UK Distributor,
Sealey Group,
Bury St. Edmunds, Suffolk.**

01284 757500

01284 703534

sales@sealey.co.uk

www.sealey.co.uk