

Thank you for purchasing a Sealey product. Manufactured to a high standard this product will, if used according to these instructions and properly maintained, give you years of trouble free performance.



IMPORTANT: PLEASE READ THESE INSTRUCTIONS CAREFULLY. NOTE THE SAFE OPERATIONAL REQUIREMENTS, WARNINGS & CAUTIONS. USE THE PRODUCT CORRECTLY AND WITH CARE FOR THE PURPOSE FOR WHICH IT IS INTENDED. FAILURE TO DO SO MAY CAUSE DAMAGE AND/OR PERSONAL INJURY AND WILL INVALIDATE THE WARRANTY. PLEASE KEEP INSTRUCTIONS SAFE FOR FUTURE USE.

1. SAFETY INSTRUCTIONS

1.1. ELECTRICAL SAFETY

WARNING! It is the responsibility of the owner and the operator to read, understand and comply with the following:

You must check all electrical products, before use, to ensure that they are safe. You must inspect power cables, plugs, sockets and any other connectors for wear or damage. You must ensure that the risk of electric shock is minimised by the installation of appropriate safety devices. A Residual Current Circuit Breaker (RCCB) should be incorporated in the main distribution board. We also recommend that a Residual Current Device (RCD) is used. It is particularly important to use an RCD with portable products that are plugged into a supply which is not protected by an RCCB. If in any doubt consult a qualified electrician. You may obtain a Residual Current Device by contacting your Sealey dealer.

You must also read and understand the following instructions concerning electrical safety.

1.1.1. The **Electricity at Work Act 1989** requires all portable electrical appliances, if used on business premises, to be tested by a qualified electrician, using a Portable Appliance Tester (PAT), at least once a year.

1.1.2. The **Health & Safety at Work Act 1974** makes owners of electrical appliances responsible for the safe condition of those appliances and the safety of the appliance operators. **If in any doubt about electrical safety, contact a qualified electrician.**

1.1.3. Ensure that the insulation on all cables and on the appliance is safe before connecting it to the power supply. See 1.1.1. and 1.1.2. and use a Portable Appliance Tester.

1.1.4. Ensure that cables are always protected against short circuit and overload.

1.1.5. Regularly inspect power supply cables and plugs for wear or damage and check all connections to ensure that none are loose.

1.1.6. **Important:** Ensure that the voltage marked on the appliance matches the power supply to be used and that the plug is fitted with the correct fuse - see fuse rating at right.

1.1.7. **DO NOT** pull or carry the appliance by the power cable.

1.1.8. **DO NOT** pull the plug from the socket by the cable.

1.1.9. **DO NOT** use worn or damaged cables, plugs or connectors. Immediately have any faulty item repaired or replaced by a qualified electrician. When an ASTA/BS approved UK 3 pin plug is damaged, cut the cable just above the plug and **dispose of the plug safely**. Fit a new plug according to the following instructions (UK only).

a) **Connect the GREEN/YELLOW earth wire to the earth terminal 'E'.**

b) **Connect the BROWN live wire to the live terminal 'L'.**

c) **Connect the BLUE neutral wire to the neutral terminal 'N'.**

d) **After wiring, check that there are no bare wires, that all wires have been correctly connected, that the cable outer insulation extends beyond the cable restraint and that the restraint is tight.**

Double insulated products, which are always marked with this symbol , are fitted with live (brown) and neutral (blue) wires only. To rewire, connect the wires as indicated above - **DO NOT** connect either wire to the earth terminal.

1.1.10. Products which require more than 13 amps are supplied without a plug. In this case you must contact a qualified electrician to ensure that a 30 amp supply is available. We recommend that you discuss the installation of an industrial round pin plug and socket with your electrician.

1.1.11. If an extension reel is used it should be fully unwound before connection. A reel with an RCD fitted is preferred since any appliance plugged into it will be protected. The cable core section is important and should be at least 1.5mm², but to be absolutely sure that the capacity of the reel is suitable for this product and for others which may be used in the other output sockets, we recommend the use of 2.5mm² section cable.

1.2. GENERAL SAFETY

WARNING! Water and electricity are dangerous partners. Be extremely cautious and always be aware that this device uses an electric motor. Always plug into a RCD (see electrical safety above). Unplug from mains before changing accessories or servicing.

WARNING! **DO NOT USE** the washer if any part of the unit, gun, nozzle, detergent tank, hose or cables is damaged. Replace or repair using genuine parts only. Unauthorised parts may be dangerous and will invalidate your warranty. Always check connections are correctly secured and not cracked or damaged in any way before using the machine.

WARNING! Use washer on a flat, levelled surface, in an upright position. Failure to do so will invalidate your warranty. **NEVER lay the washer down during use.**

✓ Ensure you comply with all local water supply regulations. Power washers may only be connected to mains drinking water supply if a back flow preventer valve is installed in the supply hose, or at the tap outlet.

✓ The supply hose must be reinforced, and have an internal diameter of 1/2". A water supply of at least 7ltr/min must be available and pressure must **NOT** exceed 6 bar. The water temperature must **NOT** exceed 50°C (122°F).

✓ Always be aware of the hazards that may occur during use. Study all applications and limitations of the washer before use.

✓ Use where air can freely circulate around the washer to avoid the machine overheating.

✓ Keep the washer in good condition. Use an authorised service agent to service the unit.

✓ Wear adequate protective clothing, goggles and anti-slip rubber soled footwear.

✓ Position the washer as near to the water supply as possible.

WARNING! Ensure all persons and animals keep at a minimum distance of 15 metres from the washer when in use.

WARNING! The pressure washer must only be used with clean water. Unfiltered water or corrosive chemicals must not be used as these will damage the cleaner.

✓ Ensure the nozzle is aimed correctly at the work surface before switching on the machine.

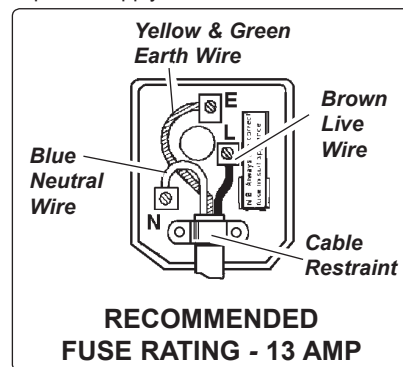

- ✓ Before activating the trigger, GRIP the gun firmly to counteract the recoil from the high pressure water jet.
- **WARNING!** Avoid sudden bursts of water as these will cause water pressure to drop and put extreme pressure on hoses and connectors.
- ✓ If, during operation, power failure occurs turn the electricity and water off for safety reasons, (See Note 'c' at end of Section 4).
- **WARNING!** The high pressure jet will cause loose particles to be propelled at high speed, which may cause serious injury.
- **WARNING!** DO NOT operate the machine without a water supply. Dry running can seriously damage the unit.
- **WARNING!** DO NOT leave the washer switched on for more than 15 minutes without operating the trigger.
- x **DO NOT** obstruct ventilation grills during operation.
- x **DO NOT** use the washer with flammable or toxic liquids or any other product. Use only recommended detergent. Unapproved detergents may corrode the machine cover and accessories.
- x **DO NOT** jam the trigger in the operating position.
- x **DO NOT** adjust any internal control valves, as they have been factory set.
- x **DO NOT** connect other appliances to the machine inlet or outlet.
- x **DO NOT** use in damp or wet weather conditions.
- x **DO NOT** move the unit by pulling the hoses or electrical cables. Use the handle.
- x **DO NOT** touch plug with wet hands. To avoid the risk of electrocution keep all connections dry and off the ground.
- x **DO NOT** direct jet against yourself, other persons, animals, electrical equipment or the machine itself.
- x **DO NOT** use washer if you are tired or under the influence of alcohol, drugs or intoxicating medication.
- x **DO NOT** allow children or untrained persons to operate the washer.
- **WARNING!** Discharge residual pressure before disconnecting the washer hose. Pressure left in unit may cause injury.
- ✓ After use, disconnect washer from electrical mains and water supply and store in a safe, dry, childproof area.

1. INTRODUCTION

Heavy-duty induction motor unit produces enough power to pump 400 litres of water every hour. Pump fitted with high pressure by-pass to preserve pump life. Features Automatic Total Stop System which switches the motor on and off when the lance trigger is operated, prolonging the motor life. Supplied with 6mtr hose, jet/flat lance and Rotablast Nozzle® which helps develop the same Effective Cleaning Power (ECP) as a 3400psi washer. Includes integral detergent tank and detergent flow control valve. Suitable for a wide range of automotive, industrial, agricultural, marine and domestic applications.

2. CONTENTS & SPECIFICATION

Unpack the product and check contents against the list below. Also check that the machine has an identification plate or label.

If label or parts are damaged or missing contact your supplier immediately.

- 1 Power cable
- 2 ON/OFF Switch
- 3 Water supply rapid attachment
- 4 Filter
- 5 Rotablast nozzle jet *
- 6 Variable nozzle jet
- 7 Spray gun
- 8 Trigger lock
- 9 Water supply attachment
- 10 High pressure pipe
- 11 Detergent tank
- 12 Hose Reel
- 13 Detergent adjustment.

* By rotating the stream of water at high speed, it is possible to increase the effective cleaning pressure of washer. We quote the pressure at which the water leaves the pump as 'Manifold Pressure' and express the cleaning power of the washer as the 'Effective Cleaning Pressure'.

2.1. SPECIFICATION

Model No.	PC3401
Manifold Pressure	100bar
Effective Cleaning Power	3400psi
Water Flow	400ltr/hr
Motor Power	1800W
Input Voltage/Current	230V/8.7A
Max. Inlet Temp.	50°C
Hose Length	6mtr
Weight	17kg

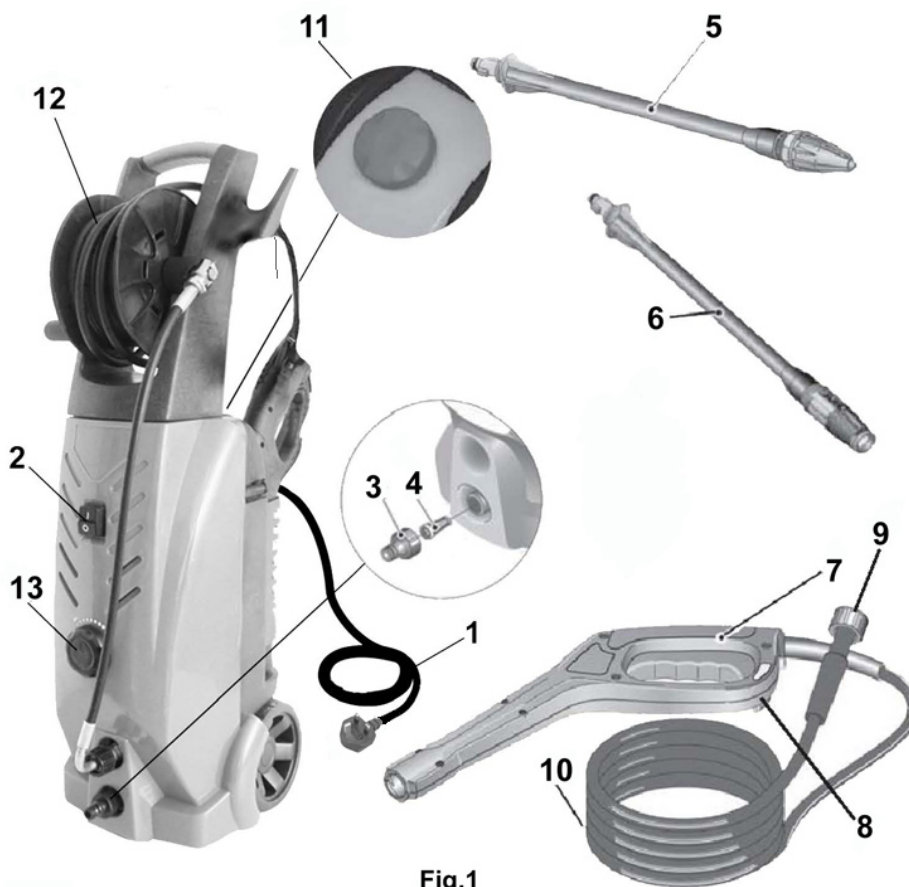
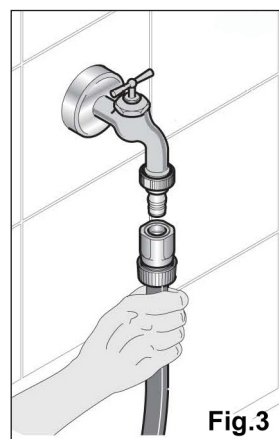
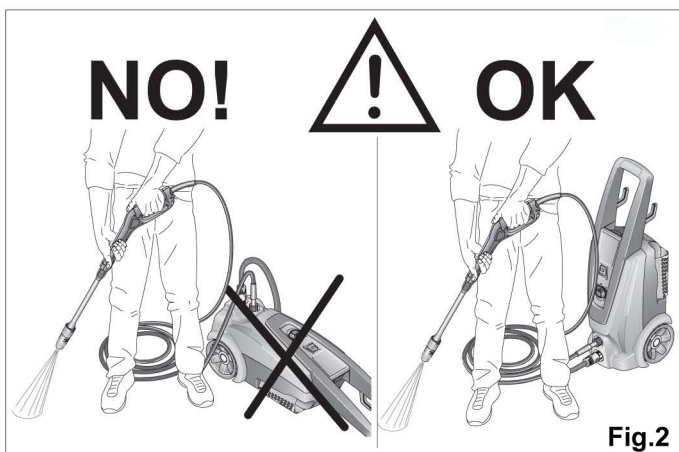

Fig.1

3. SET-UP



- **WARNING! ALWAYS use the pressure washer in the upright position as shown in Fig.2.**
- 3.1 Connecting the water supply.** Use a reinforced hose pipe with an internal diameter of 1/2" and connect to the mains water supply as indicated in Fig.3. Connect a push fit hose connector (Fig.4-1) to the water inlet on the machine (Fig.4-2). The water supply should have a minimum pressure of 1.5 bar and a maximum pressure of 6 bar, with a minimum flow rate of 7ltr/min.

Note: Ensure that the inlet filter (Fig.1-4) is fitted into the water inlet before use.

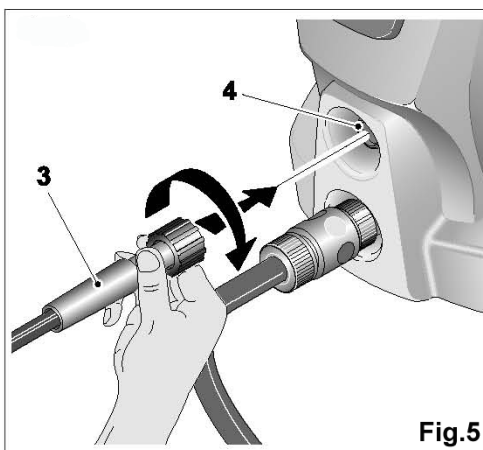
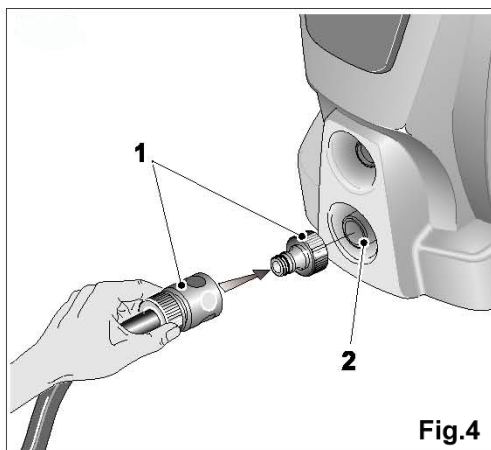

- 3.2 Connecting the high pressure hose.** Attach the high pressure hose as indicated in Fig.5 ensuring that the connector is tight. Turn on the water supply.
- 3.3 Assembling the lance and nozzle.** Push the gun onto the lance as shown in Fig.6. There is a spring within the mouth of the gun. Push the lance against the spring and turn through 90° until it clicks into place. Insert the nozzle required into the end of the lance as shown in Fig.6 and screw it down. When the nozzle is seated give it a final twist so that it clicks into place. Fig.1-6 is the variable nozzle with adjustable spray pattern. Fig.1-5 is the Rotablast nozzle.

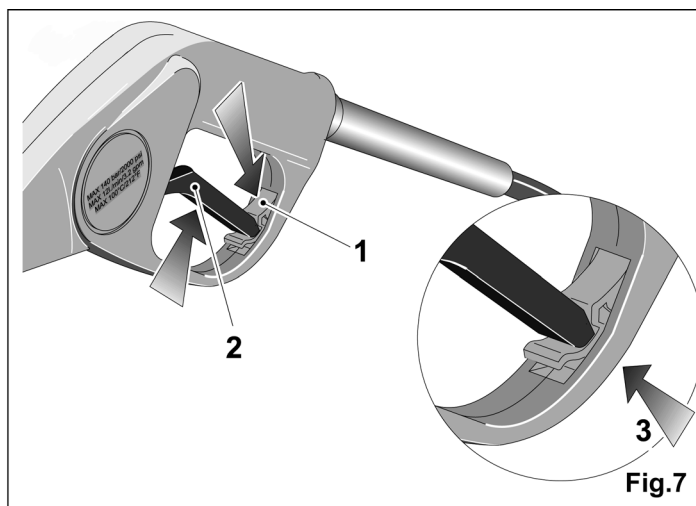
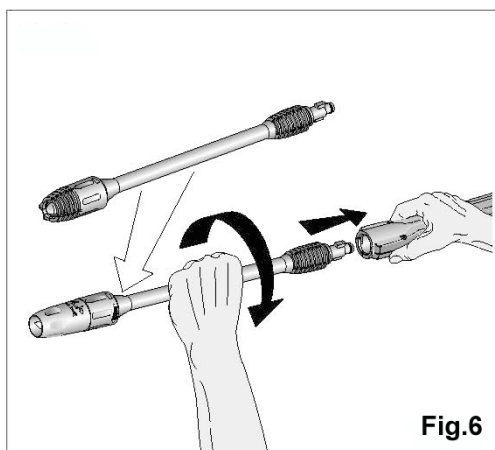

4. OPERATION

- WARNING!** Ensure you read, understand and apply Section 1 safety instructions.
- WARNING!** Dry running can seriously damage the unit.
- WARNING!** DO NOT leave washer switched on for more than 15 minutes without operating trigger.

Important! The washer motor will stop as soon as the gun trigger is released and will restart when the trigger is squeezed. Always allow at least 5 seconds between releasing the trigger and restarting.

- 4.1 Primary checks.** Check that the inlet filter is clean; pump delivery and pressure will be reduced if blocked. Never use the machine without a filter (which is fitted inside the hose connector, see Fig.1-4). Ensure that the water supply, high pressure hose and gun are correctly connected, and that air can freely circulate around the washer.
- 4.2 Operation of safety catch.** To prevent accidental operation of the unit the safety catch should always be engaged when the gun is not in use. Swing the catch into position over the end of the trigger as shown in Fig.7-3. To release the catch press it above the trigger as indicated in Fig.7-1.
- 4.3 Operating the machine.** Hold the spray gun firmly to counteract the recoil caused by the high pressure of the water. Before switching on ensure that the lance is not directed at people, objects or animals prior to being directed at the object to be cleaned. Depress the trigger before switching on the unit before every use. Switch the machine on by pressing the button marked 'I' as shown in Fig.8. Release the safety catch (see Fig.7-1). Point the lance at the object to be cleaned and fully depress the trigger. (When the trigger is released the motor will automatically switch off).
- 4.4 Adjusting spray pattern and pressure.** The spray pattern can be continuously varied from a fine jet to a fan pattern by rotating the body of the nozzle as indicated in Fig.11. Furthermore the pressure can be switched between high and low by pushing or pulling the nozzle along the axis of the lance. Shifting the nozzle forwards selects low pressure and shifting the nozzle backwards selects high pressure as shown in Fig.10.
- 4.5 Using detergent.** (Variable Nozzle only) Use only detergents approved for use in pressure washers. For soap application use the low pressure setting on the lance. (If the high pressure setting is selected detergent solution will not be discharged). Remove the cap from the detergent reservoir situated at the back of the machine and fill it with a suitable cleaning solution. Select the low pressure setting on the nozzle. The chemical will be automatically mixed with the water and discharged through the nozzle. The quantity of detergent can be adjusted by the dial on the front of the washer (Fig.9).
- 4.5.1** Dirt is dissolved by applying detergent to the dry surface. On vertical surfaces, work from the bottom upwards.
- 4.5.2** Leave the detergent to act for 1 - 2 minutes, but **DO NOT** allow the surface to dry out.
- 4.5.3** To wash down select the high pressure setting on the lance.
- 4.5.4** The Rotablast nozzle (see contents, Item 5) gives a high torque cleaning effect on larger areas (ideal for vehicle washing and removing grime from patio surfaces). Apply the high pressure jet keeping the end of the nozzle approximately 25cm (10") from the surface.
- 4.6 When washing is completed.**
- 4.6.1** Switch the power supply off by pressing the button marked 'O' as indicated in Fig.8.
- 4.6.2** Turn off the water supply tap.
- 4.6.3** Activate the trigger to discharge residual pressure until no more water comes out of the nozzle.
- 4.6.4** Engage the trigger safety catch, unplug the machine from the electrical mains power supply and disconnect from the water supply.
- 4.6.5** Wipe the machine clean and dry and store in a clean, safe, dry, childproof location.
- NOTE:**
- a) **DO NOT** leave motor switched on for more than 15 minutes without operating trigger.
 - b) If the water pressure drops (i.e. someone else using the same water supply), the washer will not operate correctly. Immediately switch off the motor and wait until the pressure is restored.
 - c) Should the motor stop and fail to restart, the built in thermal cut-out may have tripped. Check to ensure that the washer is connected correctly to electrical and water supplies (also see Section 6 Troubleshooting). Wait 3 minutes for the cut-out to reset and re-start the motor. If the motor continues to cut out contact your authorised service agent.
 - d) If storing the washer for a long period during winter, operate the washer with a non-corrosive, non-toxic anti-freeze before storage. Store detergents according to instructions on the container label.



Fig.8

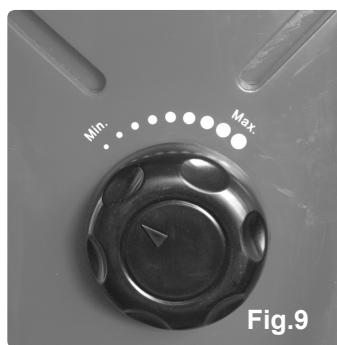

Fig.9



5. MAINTENANCE

- WARNING!** Ensure the pressure washer is switched off and unplugged from the mains electrical power supply and turned off at the mains water tap before performing any maintenance tasks.
- 5.1** Check, clean or renew the inlet filter (which is fitted inside the hose connector, see Fig.1-4) after every 50 hours of use.
- 5.2** Ensure that both nozzles are kept clean and free of debris.
- 5.3** Check unit, gun, nozzle, hose, connections and cables for damage. Immediately replace or repair with genuine parts.
- 5.4 Storage.** Do not store the unit in premises subject to freezing conditions. If this cannot be guaranteed then the unit should have a glycol based antifreeze run through it. Immerse the water supply pipe into a container of antifreeze. Immerse the gun/lance into the same container (without the nozzle attached). Hold the gun trigger open and start the unit. The antifreeze will be drawn into the unit by suction. When an even, bubble free flow is obtained switch the unit off.

6. TROUBLESHOOTING GUIDE

SYMPTOMS	REASON	REMEDY
Pump does not reach required pressure	Nozzle incorrect or worn Dirty filter Air being sucked into the system Water pressure low Worn seals	Replace the nozzle Clean or replace filter Check that hoses and fittings are air tight Check that hoses/fittings are water tight and tap is fully open Contact Authorised Service Agent
Fluctuating pressure	Nozzle worn or blocked Water too hot Pump sucking air	Replace the nozzle Reduce temperature Check that hoses and fittings are air tight
Water or oil leaks	Seals worn	Contact Authorised Service Agent
Motor does not start when switched on	No electrical power Automatic cut-off system fault	Check plug connections and mains power supply is active Contact Authorised Service Agent
Motor hums but does not start when switched on	Motor/pump jammed Unsuitable mains voltage Pump frozen Incorrect extension cable	Contact Authorised Service Agent Check for adequate power supply and cable condition Leave unit to thaw naturally. The pressure washer should be protected from the threat of freezing. Extensive pump damage could otherwise occur (see Section 4.6.5) Use a suitable extension cable. See Section 1 Elect. Safety
The motor stops	Tripped thermal cut-out due to overheating	Check that the mains voltage matches the specifications Switch off the motor and let machine cool for 3 minutes
No detergent	Detergent container is empty Detergent pick up body clogged Injector clogged Nozzle not set to low pressure Incorrect nozzle fitted	Refill detergent container Clear blockage Clean injector Move nozzle to low pressure position Fit correct nozzle (see contents, item 6)
Jet is ineffective, ragged or unsteady	High pressure nozzle clogged Selector sleeve for type of jet wrongly set	Clean high pressure nozzle Adjust selector sleeve
Fuse blows in plug	Back pressure build up of water causes machine to draw high amperage	Depress trigger before switching on the machine

Environmental Protection.



Recycle unwanted materials instead of disposing of them as waste. All tools, accessories and packaging should be sorted, taken to a recycle centre and disposed of in a manner which is compatible with the environment.



When the product is no longer required, it must be disposed of in an environmentally protective way. Contact your local solid waste authority for recycling information.

NOTE: It is our policy to continually improve products and as such we reserve the right to alter data, specifications and component parts without prior notice.

IMPORTANT: No liability is accepted for incorrect use of this product.

WARRANTY: Guarantee is 12 months from purchase date, proof of which will be required for any claim.

INFORMATION: For a copy of our latest catalogue and promotions call us on 01284 757525 and leave your full name and address, including postcode.



Sole UK Distributor, Sealey Group,
Kempson Way, Suffolk Business Park,
Bury St. Edmunds, Suffolk,
IP32 7AR



01284 757500



www.sealey.co.uk



01284 703534



sales@sealey.co.uk