

Thank you for purchasing a Sealey product. Manufactured to a high standard this product will, if used according to these instructions and properly maintained, give you years of trouble free performance.



IMPORTANT: PLEASE READ THESE INSTRUCTIONS CAREFULLY. NOTE THE SAFE OPERATIONAL REQUIREMENTS, WARNINGS & CAUTIONS. USE THE PRODUCT CORRECTLY AND WITH CARE FOR THE PURPOSE FOR WHICH IT IS INTENDED. FAILURE TO DO SO MAY CAUSE DAMAGE OR PERSONAL INJURY AND WILL INVALIDATE THE WARRANTY. PLEASE KEEP INSTRUCTIONS SAFE FOR FUTURE USE.

1. SAFETY INSTRUCTIONS

1.1. ELECTRICAL SAFETY. **WARNING!** It is the user's responsibility to read, understand and comply with the following: You must check all electrical equipment and appliances to ensure they are safe before using. You must inspect power supply leads, plugs and all electrical connections for wear and damage. You must ensure the risk of electric shock is minimised by the installation of appropriate safety devices. An RCCB (Residual Current Circuit Breaker) should be incorporated in the main distribution board. We also recommend that an RCD (Residual Current Device) is used with all electrical products. It is particularly important to use an RCD together with portable products that are plugged into an electrical supply not protected by an RCCB. If in doubt consult a qualified electrician. You may obtain a Residual Current Device by contacting your Sealey dealer. **You must** also read and understand the following instructions concerning electrical safety.

- 1.1.1. The **Electricity At Work Act 1989** requires all portable electrical appliances, if used on business premises, to be tested by a qualified electrician, using a Portable Appliance Tester (PAT), at least once a year.
- 1.1.2. The **Health & Safety at Work Act 1974** makes owners of electrical appliances responsible for the safe condition of the appliance and the safety of the appliance operator. **If in any doubt about electrical safety, contact a qualified electrician.**
- 1.1.3. Ensure the insulation on all cables and the product itself is safe before connecting to the mains power supply. See 1.1.1. & 1.1.2. above and use a Portable Appliance Tester (PAT).
- 1.1.4. Ensure that cables are always protected against short circuit and overload.
- 1.1.5. Regularly inspect power supply leads and plugs for wear and damage and all electrical connections to ensure that none is loose.
- 1.1.6. **Important:** Ensure the voltage marked on the product is the same as the electrical power supply to be used, and check that plugs are fitted with the correct capacity fuse. A 13 amp plug may require a fuse smaller than 13 amp for certain products (*subject to 1.1.10. below*) see fuse rating at right.
- 1.1.7. DO NOT pull or carry the powered appliance by its power supply lead.
- 1.1.8. DO NOT pull power plugs from sockets by the power cable.
- 1.1.9. DO NOT use worn or damage leads, plugs or connections. Immediately replace or have repaired by a qualified electrician. A U.K. 3 pin plug with ASTA/BS approval is fitted. In case of damage, cut off and fit a new plug according to the following instructions (discard old plug safely).

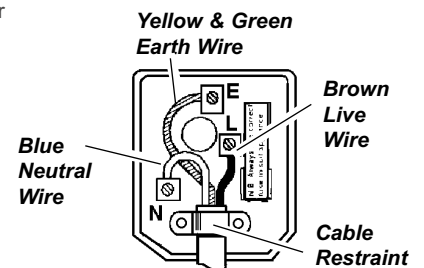

(UK only - see diagram at right). **Ensure the unit is correctly earthed via a three-pin plug.**

- a) **Connect the GREEN/YELLOW earth wire to the earth terminal 'E'.**
- b) **Connect the BROWN live wire to live terminal 'L'.**
- c) **Connect the BLUE neutral wire to the neutral terminal 'N'.**
- d) **After wiring, check there are no bare wires, that all wires have been correctly connected, that the cable external insulation extends beyond the cable restraint and that the restraint is tight.**

FUSE RATING
THIS PRODUCT MUST BE FITTED
WITH A
13 AMP FUSE

Double insulated products are often fitted with live (BROWN) and neutral (BLUE) wires only. Double insulated products are always marked with this symbol . **To re-wire, connect the brown & blue wires as indicated above. DO NOT connect the brown or blue to the earth terminal.**

- 1.1.10. Some products require more than a 13 amp electrical supply. In such a case, **NO** plug will be fitted. **You must** contact a qualified electrician to ensure a 30 amp fused supply is available. We recommend you discuss the installation of a industrial round pin plug and socket with your electrician.
- 1.1.11. **Cable extension reels.** When a cable extension reel is used it should be fully unwound before connection. A cable reel with an RCD fitted is recommended since any product which is plugged into the cable reel will be protected. The section of the cores of the cable is important. 1.5mm² section cable is the minimum but to be absolutely sure that the capacity of the cable reel is suitable for this product and for others that may be used in the other output sockets, we recommend the use of 2.5mm² section cable.

1.2 GENERAL SAFETY

- WARNING!** *Water and Electricity are dangerous partners. Be extremely cautious and always be aware that this device uses an electric motor. Always plug into a RCD (See electrical safety above). Unplug from mains before changing accessories or servicing.*
- WARNING!** *DO NOT use the washer if any part of the unit, gun, nozzle, detergent bottle, hose or cables is damaged. Replace or repair using genuine parts only. Non-authorized parts may be dangerous and will invalidate your warranty. Always check connections are correctly secured and not cracked or damaged in any way before using the machine.*
- WARNING!** *Use washer on a flat, levelled surface, in a horizontal position. Failure to do so will invalidate your warranty. NEVER stand the washer on end during use.*
- Ensure you comply with all local water supply regulations. Power washers may only be connected to mains drinking water supply if a back flow preventer valve is installed in the supply hose, or at the tap outlet.
- The supply hose must be reinforced, and have an internal diameter of 1/2". The water supply must be at least equal to the cleaner capacity. The water temperature must NOT exceed 140°F (50°C). The water supply pressure must NOT exceed 145psi (10 bar).
- Always be aware of the potential hazards that may occur during use. Study all applications and limitations of the washer before use.
- Use where air can freely circulate around the washer to avoid the machine over heating.
- Keep the washer in good condition. Use authorised service agent to service the unit.
- Wear adequate protective clothing, goggles and anti-slip rubber soled footwear.
- Position the washer as near to the water supply as possible.
- WARNING!** *Ensure all persons and animals keep at a minimum distance of 16 yards (15m) from the washer when in use.*
- WARNING!** *The pressure washer must only be used with clean water. Unfiltered water or corrosive chemicals must not be used as these will damage the cleaner.*



- 4 Ensure the nozzle is aimed correctly at the working surface before switching the machine on.
 4 Before activating the trigger, GRIP the gun firmly to counteract the recoil from the high pressure water jet.
 p **WARNING! Avoid sudden bursts of water as these will cause water pressure to drop and put extreme pressure on hoses and connectors.**
 4 If, during operation, power failure occurs turn the electricity and water off for safety reasons, (See Note 'c' at end of Section 4).
 p **WARNING! The high pressure jet will cause loose particles to be propelled at high speed, which may cause serious injury.**
 p **WARNING! DO NOT use the machine without a water supply. Dry running can seriously damage the unit.**
 p **WARNING! DO NOT leave motor running for more than 1-2 minutes without operating trigger, as temperature/pressure increase may damage sealing system.**
 8 DO NOT obstruct ventilation grills during operation.
 8 DO NOT stand the washer on its end during use. The washer must only be used when sat horizontally.
 8 DO NOT use the washer with flammable or toxic liquids or any other product. Only use recommended detergent. Unapproved detergents may corrode the machine cover and accessories.
 8 DO NOT jam the trigger in the operating position.
 8 DO NOT adjust any internal control valves, as they have been set at the factory.
 8 DO NOT leave the washer running unattended.
 8 DO NOT connect other appliances to the machine inlet or outlet.
 8 DO NOT use in damp or wet weather conditions.
 8 DO NOT move the unit by pulling the hoses or electrical cables. Use handle.
 8 DO NOT touch plug with wet hands, to avoid the risk of electrocution keep all connections dry and off the ground.
 8 DO NOT direct jet against yourself, other persons or animals, electrical equipment or the machine itself.
 8 DO NOT use washer if you are tired, under the influence of alcohol, drugs or intoxicating medication.
 8 DO NOT allow children or untrained persons to operate the washer.
 p **WARNING! Discharge residual pressure before disconnecting the washer hose. Pressure left in unit may cause injury.**
 4 After use disconnect washer from electrical mains and water supply and store in a safe, dry, childproof area.

2. SPECIFICATION & CONTENT

2.1. SPECIFICATION

Lance	Rotating Nozzle	Input Voltage	230V
Maximum Pressure	1450psi	Motor Speed	2800rpm
Effective Cleaning Power	2100psi	Max. Inlet Temp.	50°C
Water Flow375l/h	Hose Length	4.0m
Motor Power	1300W	Weight	9.5kg

By rotating the stream of water at high speed, it is possible to increase the effective cleaning pressure of washer. We quote the pressure the water leaves the pump at as 'Manifold Pressure' and express cleaning power of washer as the 'Effective Cleaning Power'.

2.2. CONTENTS

Unpack the product and check contents against the list below. Also check that the machine has an identification plate or label. If label or parts are damaged or missing contact your supplier immediately.

DESCRIPTION OF ITEMS

- 1 Water outlet
- 2 Water inlet with filter
- 3 Rotary lance
- 4 Gun with safety catch
- 5 Instruction manual
- 6 Power cord with plug
- 7 High pressure hose (attached to gun)
- 8 Nozzle cleaning tool
- 9 Motor ON/OFF switch
- 10 Detergent bottle with flow control

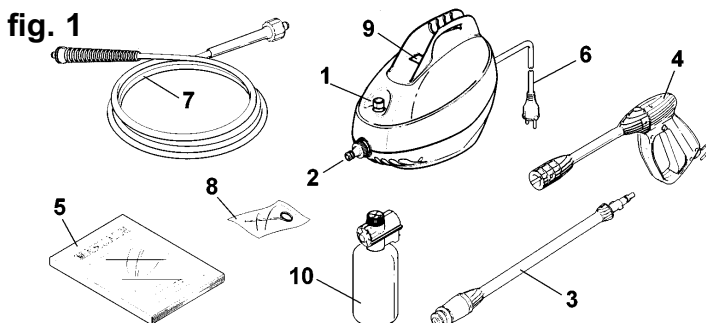

3. SET-UP

- p **WARNING! Ensure pressure washer is switched off and unplugged from the mains electrical power supply before proceeding.**
- 3.1. To connect lance (fig. 1 item 3) to the gun (4) push the lance into the end of the gun and twist to lock as in fig. 2.
 - 3.2. Connect the other end of high pressure hose to the water outlet (1) on the washer (fig. 4).
 - 3.3. Connect the mains water supply hose (not supplied) to the water inlet (2) on the pressure washer (fig. 4). DO NOT turn the water on at this stage. The supply hose must be reinforced, and have an internal diameter of 1/2". The water supply must be at least equal to the washer capacity. The water temperature must NOT exceed 140°F (50°C). The water supply pressure must NOT exceed 145psi (10 bar).
- p **WARNING! REMINDER: The pressure washer must only be used with clean water. Unfiltered water or corrosive chemicals must not be used as these will damage the washer.**
- 3.4. Check the power ON/OFF switch and ensure that it is in the 'OFF' position.
 - 3.5. Having carefully followed the safety instructions in Section 1, plug the washer into the mains power supply. The washer is now ready for use as described in Section 4.

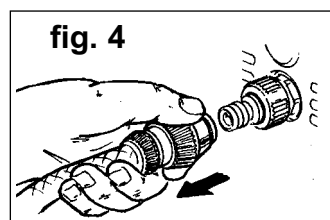
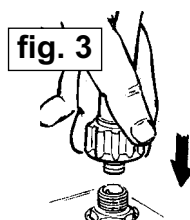
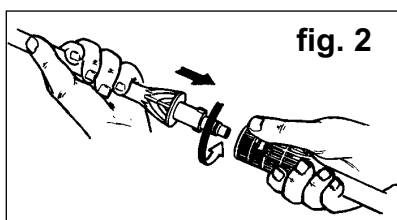

4. OPERATING THE WASHER

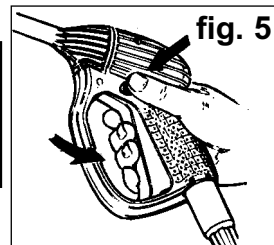

fig. 5

WARNING! Ensure you read, understand and apply Section 1 safety instructions.

WARNING! Dry running can seriously damage the unit.

WARNING! DO NOT leave motor running for more than 1-2 minutes without operating the trigger, as temperature/pressure increase may damage sealing system.

4.1. PRIMARY CHECKS

Ensure water intake is correctly connected, and air can freely circulate around the washer. Check the inlet filter is clean; pump delivery and pressure will be reduced if blocked. Never use the machine without a filter (see Section 5).

4.2. TURNING THE WASHER ON

4.2.1. Turn the mains water supply fully on.

4.2.2. Disengage the safety catch (fig. 5), and press the trigger for a few seconds to allow air to escape and to discharge residual pressure in the pipes.

4.2.3. Whilst keeping the trigger pressed, start the motor by pressing the power switch to 'ON'.

WARNING! Aim nozzle correctly at working surface.

IMPORTANT: Always ensure the trigger is pressed when starting or restarting the motor.

4.2.4. Check the system to ensure there are no water leaks.

4.3. DETERGENT

4.3.1. Fill the detergent bottle (approx 0.5l) with the recommended pressure washer detergent.

4.3.2. Fit the detergent bottle to the spray head ensuring it clips into place (fig. 6).

4.3.3. The washer is now ready for use.

4.4. TO USE THE WASHER

Dirt is dissolved by applying detergent to the dry surface. GRIP the gun firmly to counteract the recoil of the water jet and aim at the working surface.

4.4.1. On vertical surfaces, work from the bottom upwards.

The amount of detergent is controlled by turning the regulator on top of bottle (fig. 6.B).

4.4.2. Leave the detergent to act for 1 - 2 minutes, but DO NOT allow the surface to dry out.

4.4.3. To wash down, remove the detergent bottle from the nozzle by pressing the locking catch (fig. 6.A) down and pulling the nozzle out.

4.4.4. The rotary lance (fig. 7) gives a high torque cleaning effect on larger areas (ideal for vehicle washing and removing grime from patio surfaces). Apply the high pressure jet keeping the end of the nozzle approximately 25cm (10") from the surface.

4.5. WHEN WASHING IS COMPLETED

4.5.1. Switch the motor off (do not unplug from mains at this stage), and turn off the mains water supply.

4.5.2. Switch the motor back on to discharge residual pressure by pressing the trigger until no more water comes out of the nozzle.

4.5.3. Switch the motor off, engage the trigger safety catch and unplug the machine from the electrical mains power supply.

4.5.4. Wipe the machine clean and dry and store in a clean, safe, dry, childproof location.

- NOTE:**
- DO NOT leave motor running for more than 1-2 minutes without operating trigger, as pressure build-up may damage seals. Switch the motor off, but you may leave the water mains turned on.
 - If the water pressure drops (i.e. someone using same water supply), the washer will not operate correctly. Immediately switch the motor off and wait until the pressure is restored.
 - Should the motor stop and fail to restart, the built in thermal cut-out may have tripped. Check to ensure the washer is connected correctly to electrical and water supplies (also see troubleshooting). Wait 5 minutes for the cut-out to reset and re-start the motor. If the motor continues to cut out contact your authorised service agent.
 - If storing the washer for a long period during winter, operate the washer with a non-corrosive, non-toxic anti-freeze before storage. Store detergents according to instructions on the container label.

fig. 6

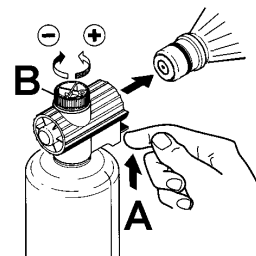
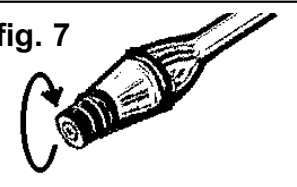

fig. 7



5. MAINTENANCE

WARNING! Ensure the pressure washer is switched off and unplugged from the mains electrical power supply and turned off at the mains water tap before proceeding.

5.1. Keep the washer clean at all times.

5.2. Check and clean suction filter (fig. 8) and **detergent filter** (at the end of the detergent pick-up pipe) after every 50 hours of use.

5.3. Lime scale deposits may form during long periods of disuse and cause the motor to seize. To release it insert a screw-driver into the slot on the rear of the motor and rotate by hand (fig. 9). Remove the screw-driver and start the motor as normal.

5.4. Take the nozzle cleaning tool (fig. 1.8), detach the lance from the gun (fig. 10) and remove any dirt from nozzle (fig. 11), then rinse.

5.5. Check unit, gun, nozzle, detergent bottle, hose, connections and cables for damage. Immediately replace or repair with genuine parts. **DO NOT open the casing, use authorised agent to service the washer.**

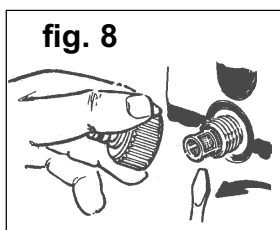

fig. 8

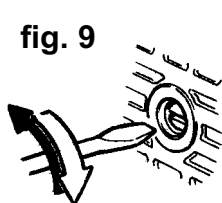

fig. 9

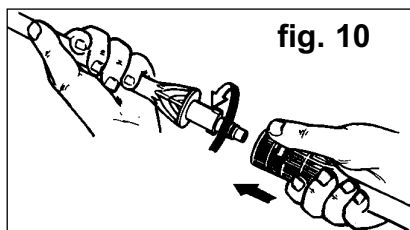

fig. 10

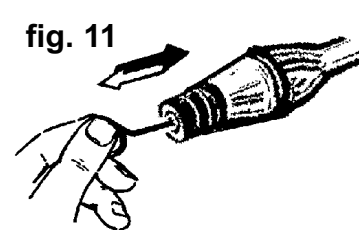

fig. 11

6. TROUBLESHOOTING GUIDE

SYMPTOM	REASON(S)	REMEDY
Pump does not reach required pressure	Nozzle incorrect or worn Dirty filter Air being sucked into the system Water pressure low Worn piston packing Valves dirty, worn or stuck	Replace the nozzle. Clean or replace filter. Check that hoses and fittings are air tight. Check that hoses/fittings are water tight and tap is fully open. Contact Authorised Service Agent. Contact Authorised Service Agent.
Pressure drops during use	Valves dirty or worn Nozzle worn or blocked Unloader valve packing worn Worn piston packing Dirty filter Water too hot	Contact Authorised Service Agent Replace the nozzle. Contact Authorised Service Agent. Contact Authorised Service Agent. Clean or replace. Reduce temperature.
Pump noisy	Pump sucking air Valves dirty or worn Worn bearings Water too hot Dirty filter	Check that hoses and fittings are air tight. Contact Authorised Service Agent. Contact Authorised Service Agent. Reduce temperature. Clean or replace
Presence of water in oil	High humidity in air Piston packing and oil seal worn	Check and replace oil twice as often. Contact Authorised Service Agent.
Oil leaks	Oil seals worn	Contact Authorised Service Agent.
Motor does not start when switched on	Plug not connected No electrical power	Check plug connections and mains power supply is active.
Motor hums but does not start when switched on	Unsuitable mains voltage Motor/pump stuck Pump frozen Incorrect extension cable	Check for adequate power supply and cable condition. Check by turning motor manually (see Section 5). If jammed return to your Sealey dealer. Leave unit to thaw naturally. The pressure washer should be protected from the threat of freezing. Extensive pump damage could otherwise occur (see end of Section 4). Use a suitable extension cable. See Section 1 Elect. Safety.
Water dripping from pump	Piston packings worn Piston guide O-ring worn	Contact Authorised Service Agent. Contact Authorised Service Agent.
The motor stops	Tripped thermal overload due to overheating	Check that the mains voltage matches the specifications. Switch off the motor and let machine cool for 5 minutes.
Fluctuating pressure	Valves worn, dirty or stuck Pump sucking air Worn piston packing Dirty filter	Contact Authorised Service Agent. Check that hoses and fittings are air tight. Contact Authorised Service Agent. Check and clean.

Declaration of Conformity We, the sole importer into the UK of Sealey Power Products, declare that the product listed below is in conformity with the following standards and directives.

Pressure Washer Model PC2100

73/23/EEC Low Voltage Directive
89/336/EEC EMC Directive



The construction file for this product is held by the Manufacturer and may be inspected, by a national authority, upon request to Jack Sealey Ltd.

Signed by Mark Sweetman

5th April 2001

For Jack Sealey Ltd. Sole importer into the UK of Sealey Power Products.

NOTE: It is our policy to continually improve products and as such we reserve the right to alter data, specifications and component parts without prior notice.

IMPORTANT: No responsibility is accepted for incorrect use of this equipment.

WARRANTY: Guarantee is 12 months from purchase, proof of which will be required for any claim.

INFORMATION: For a copy of our latest catalogue and promotions call us on 01284 757525 and leave your full name and address, including postcode.



Sole U.K. Distributor, Sealey Group,
Bury St. Edmunds, Suffolk.

01284 757500

01284 703534

E-mail: sales@sealey.co.uk