



INSTRUCTIONS FOR:
COMPRESSOR 50LTR DIRECT DRIVE 2HP
 MODEL No: **NA5020E**

Thank you for purchasing a National Machinery product. Manufactured to a high standard, this product will, if used according to these instructions, and properly maintained, give you years of trouble free performance.

IMPORTANT: PLEASE READ THESE INSTRUCTIONS CAREFULLY. NOTE THE SAFE OPERATIONAL REQUIREMENTS, WARNINGS & CAUTIONS. USE THE PRODUCT CORRECTLY AND WITH CARE FOR THE PURPOSE FOR WHICH IT IS INTENDED. FAILURE TO DO SO MAY CAUSE DAMAGE AND/OR PERSONAL INJURY AND WILL INVALIDATE THE WARRANTY. KEEP THESE INSTRUCTIONS SAFE FOR FUTURE USE.

1. SAFETY INSTRUCTIONS

1.1. ELECTRICAL SAFETY

WARNING! It is the responsibility of the owner and the operator to read, understand and comply with the following: You must check all electrical products, before use, to ensure that they are safe. You must inspect power cables, plugs, sockets and any other connectors for wear or damage. You must ensure that the risk of electric shock is minimised by the installation of appropriate safety devices. A Residual Current Circuit Breaker (RCCB) should be incorporated in the main distribution board. We also recommend that a Residual Current Device (RCD) is used. It is particularly important to use an RCD with portable products that are plugged into a supply which is not protected by an RCCB. If in any doubt consult a qualified electrician. You may obtain a Residual Current Device by contacting your dealer. You must also read and understand the following instructions concerning electrical safety.

- 1.1.1. The **Electricity at Work Act 1989** requires that all portable electrical appliances, if used on business premises, are tested by a qualified electrician, using a Portable Appliance Tester (PAT), at least once a year.
- 1.1.2. The **Health & Safety at Work Act 1974** makes owners of electrical appliances responsible for the safe condition of those appliances and the safety of the appliance operators. **If in any doubt about electrical safety, contact a qualified electrician.**
- 1.1.3. Ensure that the insulation on all cables and on the appliance is safe before connecting it to the power supply. See 1.1.1. and 1.1.2. and use a Portable Appliance Tester.
- 1.1.4. Ensure that cables are always protected against short circuit and overload.
- 1.1.5. Regularly inspect power supply cables and plugs for wear or damage and check all connections to ensure that none is loose.
- 1.1.6. **Important:** Ensure that the voltage marked on the appliance matches the power supply to be used and that the plug is fitted with the correct fuse - see fuse rating at right.
- 1.1.7. **DO NOT** pull or carry the appliance by the power cable.
- 1.1.8. **DO NOT** pull the plug from the socket by the cable.
- 1.1.9. **DO NOT** use worn or damaged cables, plugs or connectors. Immediately have any faulty item repaired or replaced by a qualified electrician. When a BS 1363/A UK 3 pin plug is damaged, cut the cable just above the plug and dispose of the plug safely.

Fit a new plug according to the following instructions (UK only).

- a) **Connect the GREEN/YELLOW earth wire to the earth terminal 'E'.**
- b) **Connect the BROWN live wire to the live terminal 'L'.**
- c) **Connect the BLUE neutral wire to the neutral terminal 'N'.**
- d) **After wiring, check that there are no bare wires, that all wires have been correctly connected, that the cable outer insulation extends beyond the cable restraint and that the restraint is tight.**







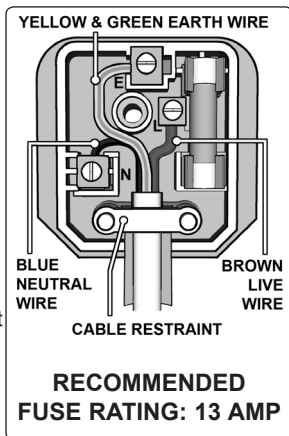

Double insulated products, which are always marked with this symbol , are fitted with live (brown) and neutral (blue) wires only. To rewire, connect the wires as indicated in diagram.

DO NOT connect either wire to the earth terminal.

- 1.1.10. Products which require more than 13 amps are supplied without a plug. In this case you must contact a qualified electrician to ensure that a suitably rated supply is available.



Guide to symbols

	Warning: Electricity		DO NOT open the air cock before an air hose is attached
	Warning: Hot Surface		DO NOT operate the compressor with enclosure displaced
	Warning: Automatic start up		Ensure oil level is correct before first use
	Wear ear protection		Read the instruction manual before use



We recommend that you discuss the installation of an industrial round pin plug and socket with your electrician. **IMPORTANT!** The use of extension leads to connect these compressors to the mains is not recommended as the resulting voltage drop reduces motor, and therefore pump performance.

1.2. GENERAL SAFETY

- ✓ Familiarise yourself with the application and limitations of the compressor.
- ✓ Ensure the compressor is in good order and condition before use. If in any doubt do not use the unit and contact an electrician/service agent.
- ☐ **WARNING! Compressor must only be serviced by an authorised agent. DO NOT tamper with, or attempt to adjust, pressure switch or safety valve.**
- ✓ Before moving, or maintaining the compressor ensure it is unplugged from the mains supply and that the air tank pressure has been vented.
- ✓ Maintain the compressor in good condition and replace any damaged or worn parts. Use genuine parts only. *Unauthorised parts may be dangerous and will invalidate your warranty.*
- ✓ Read the instructions relating to any accessory to be used with this compressor. Ensure the safe working pressure of any air appliance used exceeds compressors output pressure. If using a spray a gun, check that the area selected for spraying is provided with an air change/ventilation system.
- ✓ Ensure the air supply valve is turned off before disconnecting the air supply hose.
- ✓ To move the compressor use the handle only. Maintain unit's centre of gravity when lifting. **DO NOT** attempt to lift or move the compressor by any other means.
- ✓ Use the compressor in a well ventilated area and ensure it is placed on a firm surface.
- ✓ Keep tools and other items away from the compressor when it is in use, and keep area clean and clear of unnecessary items.
- ✓ Ensure the air hose is not tangled, twisted or pinched.

- ✓ Keep children and unauthorised persons away from the working area.
- ✗ **DO NOT** dismantle the compressor for any reason. The unit must be checked by qualified personnel only.
- ✗ **DO NOT** use the compressor outdoors, or in damp, or wet, locations.
- ✗ **DO NOT** operate within the vicinity of flammable liquids, gases or solids.
- ✗ **DO NOT** touch compressor cylinder, cylinder head or pipe from head to tank as these may be hot.
- ✗ **DO NOT** use this product to perform a task for which it has not been designed.
- ✗ **DO NOT** deface the certification plate attached to the compressor tank.
- ✗ **DO NOT** cover the compressor or restrict air flow around the unit whilst operating.
- ▲ **DANGER! DO NOT** direct the output jet of air towards people or animals.
- ✗ **DO NOT** operate the compressor without an air filter.
- ✗ **DO NOT** allow anyone to operate the compressor unless they have received full instructions.
- **WARNING!** The air tank is a pressure vessel and the following safety measures apply:
 - ✗ **DO NOT** tamper with the safety valve, **DO NOT** modify or alter the tank in any way and **DO NOT** strap anything to the tank.
 - ✗ **DO NOT** subject the tank to impact, vibration or to heat and **DO NOT** allow contact with abrasives or corrosives.
- **WARNING!** If an electrical fuse blows, ensure it is replaced with an identical fuse type and rating.
- ✓ When not in use, store the compressor carefully in a safe, dry, childproof location.
- ✗ **DO NOT** carry out any welding operations on any pressurised parts of the vessel.

2. INTRODUCTION & SPECIFICATION

All models feature aluminium cylinder heads fitted with aluminium motor windings. Cast iron cylinder gives added resistance to wear. Suitable for general purpose applications. Pump head directly coupled to induction motor for quiet operation. Welded tank complies with latest European standards. Fitted with fully automatic pressure cut-out switch with twin gauges displaying tank and working pressures. Fitted with ASTA/BS approved non-rewireable plug.

MODEL:	NA5020E
Motor output:	2hp
Voltage/phase:	230V - 1ph
Rated supply:	13A
Noise level:	97LwA
Air displacement:	6.8cfm/193l/m
Maximum free air delivery:	4.6cfm/130l/m
Tank capacity:	50ltr
Max pressure:	116psi/8bar
Weight:	29kg
Dimensions (W x D x H):	650 x 390 x 669mm

3. PREPARATION & ASSEMBLY

- 3.1. Remove compressor from packaging and inspect for any shortages or damage. If anything is found to be missing or damaged contact your supplier.
- 3.2. Confirm that the mains voltage corresponds with the voltage shown on the compressor data plate.
- 3.3. The compressor should be installed on a flat surface, or one that does not exceed 10° either transversely or longitudinally, (see fig.1) and should be in a position that allows good air circulation around the unit.
- 3.4. **IMPORTANT!** The compressor is supplied without oil in it. The oil is in a separate container. Remove the transit plug from the oil filler aperture, pour oil into the aperture until it has reached the correct level on the sight glass (fig.2B). Fit the oil filler/breather supplied into the aperture.
DO NOT ATTEMPT TO RUN THE COMPRESSOR UNTIL THIS HAS BEEN DONE.
- 3.5. **Ensure that the air vent in the oil filler/breather is free from debris. If the air vent is blocked, pressure can build up in the crankcase causing damage to the compressor and possible personal injury.**
- 3.6. Fit the air filter into the inlet port if required (fig.4).

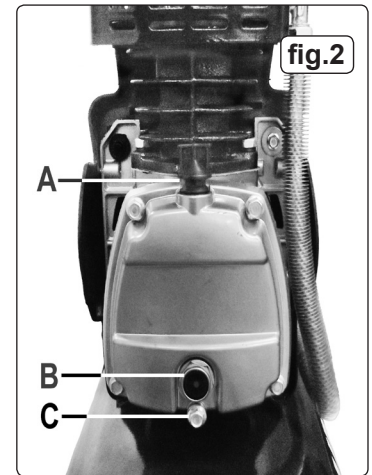
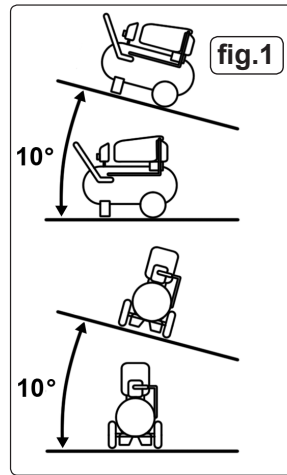

4. TOOL SELECTION

IMPORTANT Take care when selecting tools for use with the compressor. Air tool manufacturers normally express the volume of air required to operate a tool in cubic feet per minute (cfm). This refers to free air delivered by the compressor ('air out') which varies according to the pressure setting. Do not confuse this with the compressor displacement which is the air taken in by the compressor ('air in'). 'Air out' is always less than 'air in' - due to losses within the compressor - and so it is important that, before choosing equipment, you study the 'Free Air Delivery' figures shown in the Specification Chart.

5. OPERATION

- **WARNING! ENSURE THAT YOU HAVE READ, UNDERSTOOD AND APPLIED SECTION 1 SAFETY INSTRUCTIONS.**
 - 5.1. Make sure that the main switch (fig.3.1) is 'OFF' (down).
 - 5.2. Check the oil level by looking through the sight glass (See fig.2B).
 - 5.3. Ensure that the tank drain valve is closed (fig.5).
 - 5.4. Close the outlet pressure regulator by turning the knob clockwise (fig.3.2).
 - 5.5. Connect the air tool required to the compressor via an air line connected to the air outlet.
 - 5.6. Plug the mains cable into the mains supply and start the compressor by pulling up the main switch.
 - 5.7. Allow the pressure in the tank to rise to the maximum at which point the compressor will automatically cut out. Tank pressure is shown on the larger gauge (fig.3.5).
 - 5.8. Begin to gradually open the regulator by turning the knob until the small gauge registers the required operating pressure specified for the tool to be used. Always **adjust up** to the required pressure rather than down from a higher pressure. The required setting, once achieved, can be locked by screwing the locking ring (fig.3.3) up tight underneath the adjusting knob.
 - 5.9. You can now begin to use the tool. The compressor will operate automatically cutting in and out as required to restore the air pressure in the tank. The pressure switch (fig.3.7) stops the motor when the maximum tank pressure is reached and restarts it when pressure falls below the minimum threshold - approximately 2bar (29psi) less than the maximum pressure.
- Note:
- a) If the motor does not cut in and out, but runs continuously when using an air appliance, the capacity of the compressor may be too small for the appliance.
 - b) The main gauge (fig.3.5) indicates the pressure inside the main tank, **NOT** the pressure supplied to the air equipment, which is shown on the smaller gauge (fig.3.4). Should the pressure in the main tank exceed the pre-set switch (fig.3.7) maximum, the safety valve (fig.3.6) will activate.

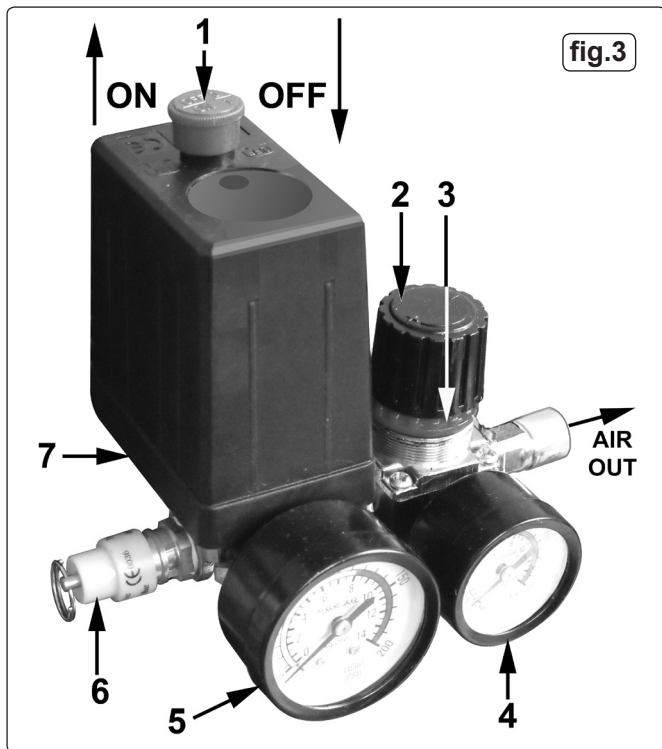

fig.3

- ❑ **WARNING! For this reason DO NOT tamper with, or adjust, the switch or the safety valve.**
When the compressor is not being used set the regulated pressure to zero so as to avoid damaging the pressure regulator.
- 5.10. To stop the compressor press down the main switch (fig.3.1). When the compressor stops there will be a whistling sound as compressed air is vented from the compressor head. **DO NOT**, other than in an emergency, stop the compressor by switching off the mains power, or by pulling the plug out, as the pressure relief will not then occur and motor damage may result upon restart.
- 5.11. When you have finished using the compressor unplug the unit from the mains power supply.
- 5.12. Set the outlet pressure on the regulator to zero.
- 5.13. Remove the air line and air tool.
- 5.14. The tank must now be drained. This will release the air left in the tank and drain away condensation that may have formed within the tank. Choose a suitable location for this operation and/or make provision to collect the condensation. **Wear ear and eye protection.** Open the tank drain valve (See fig.5) slowly allowing air and moisture to bleed from the tank. After bleeding close the drain valve to prevent debris building up in the valve.
- ❑ **WARNING! Water that is allowed to remain in the tank during storage will corrode and weaken the air tank which could cause the tank to rupture. To avoid serious injury drain the tank after each use or daily.**
- 5.15. **SAFETY FEATURES**
Thermal cut out: If the unit overheats the thermal cut out will operate and shut the unit down. Allow the unit to cool down then press the reset button, located just inside the pump cover (fig.7).

6. MAINTENANCE

- ❑ **WARNING! Before performing any maintenance operation, switch the compressor off, disconnect from electricity supply and release all air from the tank. In order to keep the compressor in good working condition, periodical maintenance is essential.**
- 6.1. After the first 50 working hours replace the lubricating oil - see para 6.4.
- 6.2. Operations to be carried out daily:
 - a) Drain condensation, place a container under the valve and open the valve by turning anti-clockwise (fig.5). Retighten the valve.
 - b) Check that all nuts and bolts are tight, particularly those retaining the crankcase and cylinder head.

- 6.3. **OPERATIONS TO BE CARRIED OUT EVERY 100 HOURS:** (or more frequently, if the compressor operates in a very dusty atmosphere):
 - a) Check oil level and, if necessary, top up.
 - b) Remove the filter element (fig.4) and clean by blowing through with an air line at low pressure, from the clean side. Alternatively, wash in soapy water, rinse and dry. Do not operate the compressor without the filter as foreign bodies or dust could seriously damage the pump.
 - c) Check for oil leaks
- 6.4. **OPERATIONS TO BE CARRIED OUT EVERY 200 HOURS:**
 - a) Replace the lubricating oil. For oil specifications see below. Remove the oil filler plug (fig.2A) and undo the drain bolt (fig.2C), draining the oil into a container. Drain when the compressor is hot so that oil drains rapidly and completely. Incline compressor to ensure complete drainage. Replace the drain bolt and refill with fresh oil through the filler aperture. **DO NOT** overfill. Replace plug (fig.2A). Recommended oil for compressors, Suitable for room temperatures ranging from +5°C to +25°C. SEALEY CPO or equivalent SAE 40 compressor oil. Room temperature below +5°C: SAE 20 compressor oil.
 - ❑ **WARNING! Never mix different oils and do not use non-detergent/low quality oils as the compressor may be damaged. Dispose of waste oil only in accordance with local authority requirements.**
 - a) Check the automatic cut-out at max. pressure and the automatic cut-in at 2 bar below.
- 6.5. **OPERATIONS TO BE CARRIED OUT EVERY 500 HOURS:**
 - a) Replace air filter.
 - b) Check all tube fittings and electrical connections.**IMPORTANT! Failure to carry out maintenance tasks may invalidate the warranty on your compressor.**

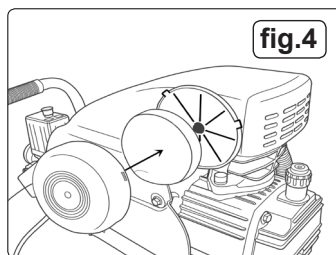

fig.4

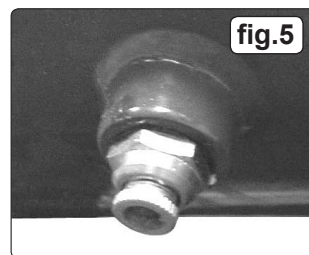

fig.5

6.6. Scheduled maintenance table

Maintenance Operations	Daily	100 hrs.	200 hrs.	500 hrs.
Drain condensation	•			
Check oil level		•		
Clean intake filter		•		
Check for oil leaks		•		
Check cut-out			•	
Replace oil			•	
General cleaning of compressor			•	
Replace air filter				•
Check tube fittings and electrical connections				•

- 6.7. **Inspection of pressure tank both inside and out.**
Under the **PRESSURE SYSTEMS SAFETY REGULATIONS 2000**, it is the responsibility of the owner of the compressor to initiate a system of inspection that both defines the frequency of the inspection and appoints a person who has specific responsibility for carrying out the inspection.
- 6.8. **IMPORTANT WARNING - Air contaminants taken into the compressor will affect optimum performance.** Example: Body filler dust or paint overspray will clog the pump intake filter and may cause internal damage to pump/motor components. Please note that any parts damaged by any type of contamination will not be covered by warranty.

7. TROUBLESHOOTING

FAULT	CAUSE	REMEDY
1A) Pressure drop in the tank	Air leaks at connections	Run compressor to max. pressure, switch off Brush soap solution over connections and look for bubbles. Tighten connections showing leaks If problem persists contact Authorised Service Agent
1B) Pressure drop in the tank	Air leaks from safety valve	Operate the safety valve manually by pulling on the ring. If valve continues to leak when in the closed position it should be replaced
1C) Pressure drop in the tank	Air leaks from cylinder head gasket	Check tightness of head bolts. If leak continues contact Authorised Service Agent
2) Pressure switch valve leaks when compressor is idle	Non-return valve seal defective	Empty the air tank. Referring to fig.6, remove the non-return valve cap (3), spring (2) and seal (1) Clean the seal and its seat, or if necessary replace the seal
3) Air leaks from tank body or tank welds	Internal corrosion caused by infrequent tank draining or non permitted modifications to tank	Tank could rupture or explode. Cannot be repaired DISCONTINUE USE IMMEDIATELY
4A) Motor stops and will not restart	Thermal cut out has operated	Allow unit to cool for 30 minutes, then press reset see fig.7.
4B) Motor stops and will not restart	Supply fuse has tripped	Reset fuse and restart unit. If repeated tripping occurs replace the check valve or contact authorised service agent
5) Compressor stops and does not restart	Motor failure	Contact Authorised Service Agent
6A) Compressor does not stop at max. pressure	Pressure switch fault	Contact Authorised Service Agent
6B) Compressor does not stop at max. pressure	Filter clogged Head gasket or valve fault	Replace filter element. Contact Authorised Service Agent
7) Compressor noisy with metallic knock	Bearing or piston damage	Contact Authorised Service Agent
8) Excessive moisture in discharged air	High humidity environment	Drain tank after each use

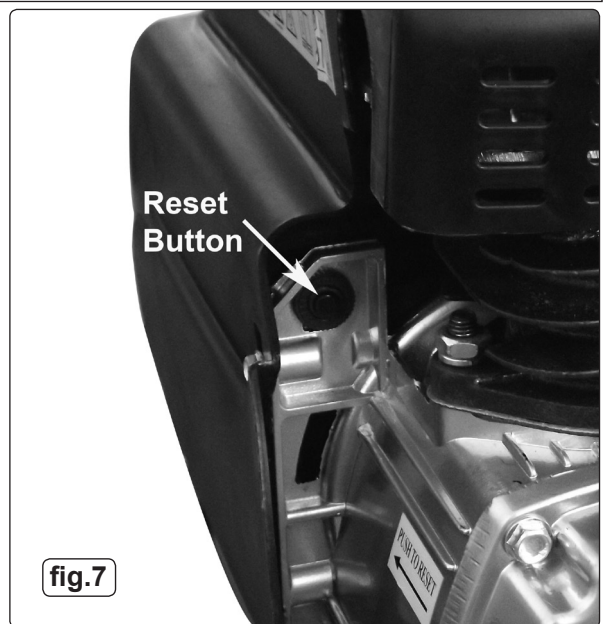
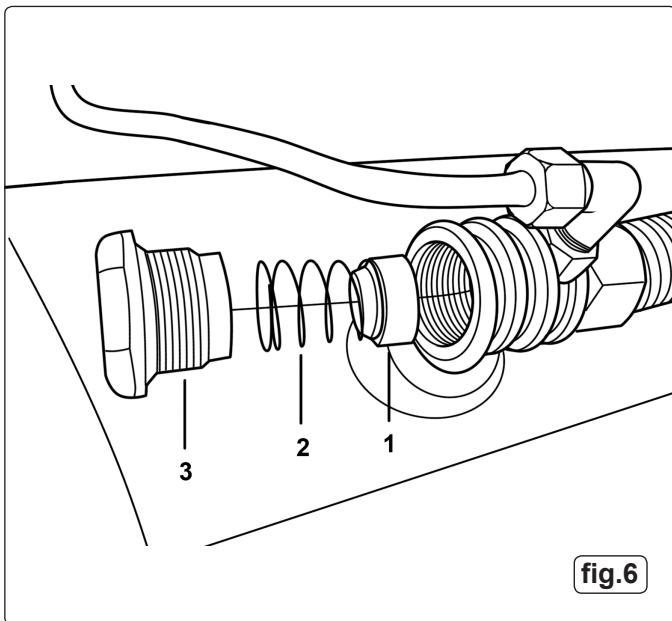

Environmental Protection.

Recycle unwanted materials instead of disposing of them as waste. All tools, accessories and packaging should be sorted, taken to a recycle centre and disposed of in a manner which is compatible with the environment.
When the product becomes completely unserviceable and requires disposal, drain off the oil into an approved container and dispose of the product and the oil according to local regulations.



WEEE Regulations.

Dispose of this product at the end of its working life in compliance with the EU Directive on Waste Electrical and Electronic Equipment. When the product is no longer required, it must be disposed of in an environmentally protective way. Contact your local solid waste authority for recycling information.

NOTE: It is our policy to continually improve products and as such we reserve the right to alter data, specifications and component parts without prior notice.

IMPORTANT: No liability is accepted for incorrect use of this product.

WARRANTY: Guarantee is 12 months from purchase date, proof of which will be required for any claim.



National Machinery
Kempson Way, Suffolk Business Park,
Bury St. Edmunds, Suffolk,
IP32 7AR



01284 757500

01284 703534