

INSTRUCTIONS FOR

INVERTERS

Models:

MW100.V3

MW130.V3



Thank you for purchasing a Sealey product. Manufactured to a high standard this product will, if used according to these instructions and properly maintained, give you years of trouble free performance.

IMPORTANT: BEFORE USING THIS PRODUCT, PLEASE READ THE INSTRUCTIONS CAREFULLY. MAKE CAREFUL NOTE OF SAFETY INSTRUCTIONS, WARNINGS AND CAUTIONS. THIS PRODUCT SHOULD ONLY BE USED FOR ITS INTENDED PURPOSE. FAILURE TO DO SO MAY CAUSE DAMAGE AND/OR PERSONAL INJURY AND WILL INVALIDATE THE WARRANTY. RETAIN THESE INSTRUCTIONS FOR FUTURE USE.

1. SAFETY INSTRUCTIONS

1.1. ELECTRICAL SAFETY

WARNING! It is the responsibility of the owner and the operator to read, understand and comply with the following:

You must check all electrical products, before use, to ensure that they are safe. You must inspect power cables, plugs, sockets and any other connectors for wear or damage. You must ensure that the risk of electric shock is minimised by the installation of appropriate safety devices. A Residual Current Circuit Breaker (RCCB) should be incorporated in the main distribution board. We also recommend that a Residual Current Device (RCD) is used. It is particularly important to use an RCD with portable products that are plugged into a supply which is not protected by an RCCB. If in any doubt consult a qualified electrician. You may obtain a Residual Current Device by contacting your Sealey dealer. **You must** also read and understand the following instructions concerning electrical safety.

1.1.1. The **Electricity at Work Act 1989** requires that all portable electrical appliances, if used on business premises, are tested by a qualified electrician, using a Portable Appliance Tester (PAT), at least once a year.

1.1.2. The **Health & Safety at Work Act 1974** makes owners of electrical appliances responsible for the safe condition of those appliances and the safety of the appliance operators. **If in any doubt about electrical safety, contact a qualified electrician.**

1.1.3. Ensure that the insulation on all cables and on the appliance is safe before connecting it to the power supply. See 1.1.1. and 1.1.2. and use a Portable Appliance Tester.

1.1.4. Ensure that cables are always protected against short circuit and overload.

1.1.5. Regularly inspect power supply cables and plugs for wear or damage and check all connections to ensure that none is loose.

1.1.6. **Important:** Ensure that the voltage marked on the appliance matches the power supply to be used and that the plug is fitted with the correct fuse - see fuse rating at right.

1.1.7. **DO NOT** pull or carry the appliance by the power cable.

1.1.8. **DO NOT** pull the plug from the socket by the cable.

1.1.9. **DO NOT** use worn or damaged cables, plugs or connectors. Immediately have any faulty item repaired or replaced by a qualified electrician. When a BS 1363/A UK 3 pin plug is damaged, cut the cable just above the plug and **dispose of the plug safely.** Fit a new plug according to the following instructions (UK only).

a) **Connect the GREEN/YELLOW earth wire to the earth terminal 'E'.**

b) **Connect the BROWN live wire to the live terminal 'L'.**

c) **Connect the BLUE neutral wire to the neutral terminal 'N'.**

d) **After wiring, check that there are no bare wires, that all wires have been correctly connected, that the cable outer insulation extends beyond the cable restraint and that the restraint is tight.**

Double insulated products, which are always marked with this symbol , are fitted with live (brown) and neutral (blue) wires only. To rewire, connect the wires as indicated above - **DO NOT** connect either wire to the earth terminal.

1.1.10. Products which require more than 13 amps are supplied without a plug. In this case you must contact a qualified electrician to ensure that a suitably rated supply is available. We recommend that you discuss the installation of an industrial round pin plug and socket with your electrician.

1.1.11. If an extension reel is used it should be fully unwound before connection. A reel with an RCD fitted is preferred since any appliance plugged into it will be protected. The cable core section is important and should be at least 1.5mm², but to be absolutely sure that the capacity of the reel is suitable for this product and for others which may be used in the other output sockets, we recommend the use of 2.5mm² section cable.

1.1.12. **WARNING!** Be very cautious if using a diesel generator. The generator must be stable with regard to frequency (H3), voltage and wave form. The output must be higher than the power (kVA) of the inverter. The diesel generator must also be self regulating. If any A.M. feature is not respected the working of the regulation card may be affected.

Use of a generator without a regulator may be dangerous and will invalidate your inverter warranty.

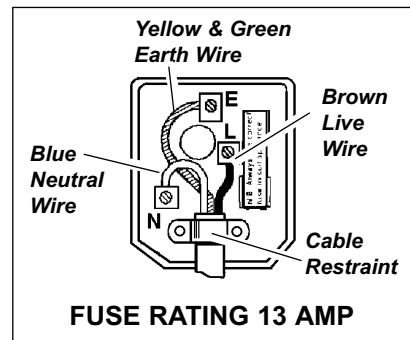

1.2. GENERAL SAFETY

DANGER! **Unplug the inverter from the mains power supply before connecting or disconnect cables or performing maintenance or service. Direct contact with the inverter circuit is dangerous.**

✓ Keep the inverter and cables in good working order and condition. *Take immediate action to repair or replace damaged parts.*

✓ Use genuine parts and accessories only. *Unapproved parts may be dangerous and will invalidate the warranty.*

✓ Keep the inverter clean for best and safest performance.

✓ Locate the inverter in a suitable work area. Ensure that the area has adequate ventilation as welding fumes are harmful.

WARNING! **Cable connectors must be turned fully into the quick plugs to ensure a good electrical contact. Loose connections will cause overheating, rapid deterioration and loss in efficiency.**

✓ Ensure that there is no obstruction to the flow of clean, cool air and ensure that there are no conductive dusts, corrosive vapours or humidity which could enter the inverter and cause serious damage.

✓ Keep the work area clean and tidy and free from unrelated materials. Also ensure that the work area has adequate lighting.

WARNING: **Use welding head shield to protect eyes and avoid exposing skin to ultraviolet rays given off by electric arc. Wear safety welding gauntlets.**

✓ Remove ill fitting clothing, remove ties, watches, rings and other loose jewellery and contain long hair.

✓ Ensure that the workpiece is correctly secured before operating the inverter.

- ✓ Avoid unintentional contact with workpiece. Accidental or uncontrolled switching on of the torch may be dangerous and will wear the nozzle.
- ✓ Protect cables from heat and sharp or abrasive items.
- ✓ Keep unauthorised persons away from the work area. Any persons working within the area must adorn the same protective items.
- ✓ Operators must receive adequate training before using the inverter.
- ✓ Stand correctly keeping a good footing and balance, ensure that the floor is not slippery and wear non-slip shoes.
- ❑ **WARNING: When unit is switched off the short-circuit light (fig 4. B) will come on for 10-15 seconds whilst capacitor discharges. DO NOT open unit until light goes out.**
- ✓ Turn voltage switch to "0" (Off) when not in use.
- ✗ DO NOT operate the inverter if it or the cables are damaged.
- ✗ DO NOT use welding cables over 10m in length.
- ✗ DO NOT attempt to fit any unapproved torches, components, or parts to the inverter unit.
- ✗ DO NOT connect the return cable to any metallic structure which is not part of the workpiece. This will jeopardise weld quality and may be dangerous. *Exception:* Metallic work bench, but connect as near to weld as possible.
- ✗ DO NOT hit the electrode on the workpiece, this may damage the electrode and make strike-up difficult.
- ✗ DO NOT get inverter wet or use in damp or wet locations or areas where there is condensation.
- ✗ DO NOT weld without a welding safety head shield.
- ▲ **DANGER! DO NOT weld near flammable materials - solids, liquids, or gases.**
- ✗ DO NOT weld containers or pipes which have held flammable materials - gases, liquids or solids. Avoid operating on materials cleaned with chlorinated solvents or near such solvents.
- ✗ DO NOT pull the inverter by the cables, or the torch.
- ✗ DO NOT bend, strain or stand on cables.
- ✗ DO NOT place cables where they will endanger others. Long lengths of slack must be gathered and neatly coiled.
- ✗ DO NOT touch the workpiece close to the weld as it will be very hot. Allow to cool.
- ✗ DO NOT touch the torch immediately after use. Allow the torch to cool.
- ✗ DO NOT operate the inverter while under the influence of drugs, alcohol or intoxicating medication, or if tired.
- ✓ When not in use, store the inverter in a safe, dry, childproof area.

2. DESCRIPTION

2.1. INTRODUCTION

These Inverters are lightweight, powerful and versatile. They are suitable for ARC or TIG welding using "Scratch-Start" method. Both have Arc-Force circuitry making them suitable for welding a wide variety of rods including rutilite, basic and stainless of various sizes (see specifications). Machines also include thermal cut-out and mains voltage LEDs and are fitted with Hot-Start systems to counter electrode sticking during scratch-starting. Supplied in carry case with ARC welding accessory kit and shoulder strap. Also suitable for tig welding with optional TIG accessory kit (Part No. INV/TIG).

2.2. DESCRIPTION

These models are "constant current rectifiers" for ARC welding and are controlled by a transistor bridge. The specific characteristics of the "INVERTER" system provide high speed and precise regulation, ensuring a high quality result for both stick electrode and TIG welding (DC). The "INVERTER" system, regulated at the input of the primary mains, also allows for a drastic reduction in the volumes of both the transformer and the reactance. This reduction in volume and weight enhances the mobility of the machines. The units have power modules which have been developed on a special printed circuit designed to maximise reliability and reduce maintenance.

2.3. CIRCUIT SYSTEM DESCRIPTION Refer to fig. 1.

1. Mains input (single phase), rectifier unit and condenser.
2. Transistors and drivers switching bridge (IGBT). Turns the mains rectified voltage into high frequency alternating voltage and permits power regulation according to the current/voltage of the weld.
3. High frequency transformer: The primary windings are fed by the voltage adapting voltage and current to the values required by the ARC welding procedure and, simultaneously, isolates the welding circuit from the mains.
4. Secondary rectifier bridge with inductance. Changes the alternating current supplied by the secondary windings into direct current.
5. Electronic and regulation board: Instantly checks the value of the welding current against that selected by the user. It modulates the commands of the IGBT drivers, which control regulation. The control board also determines the dynamic response of the current transient during the phases of electrode fusion (instant short circuit), and is responsible for the safety system.

converted by Block 2 It has the function of

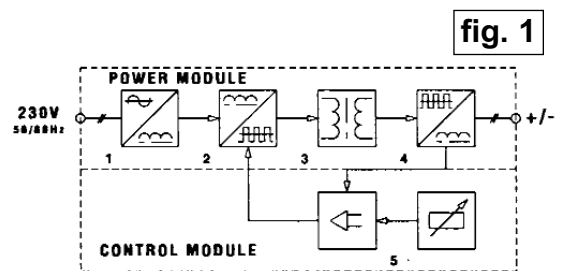

3. SPECIFICATIONS

3.1. SPECIFICATIONS

Model No.	MW100	MW130
Output:	5 - 85A	5 - 125A
Duty Cycle:	25% @ 85A	15% @ 125A
Electrode Capacity:	Ø1.6 - 2.5mm	Ø1.6 - 3.2mm
Max Absorbed Power:	2.8kW	3.5kW
Mains Voltage:	230V - 1ph	230V - 1ph
Insulation Class:HH
Protection:IP21IP21
Weight:	3.6kg	3.7kg
ARC Accessory Ref:INV/10 (Included)INV/10 (Included)
TIG Accessory Ref:INV/TIG (Not Included)INV/TIG (Not Included)



4. ASSEMBLY

Unpack the product and check contents. Should there be any damaged or missing parts contact your supplier immediately.

- ❑ **WARNING! Ensure that the inverter is not plugged into the mains power supply before assembling, connecting or disconnecting cables. For electrical installation, see Safety Instructions (Section 1).**
- ❑ **WARNING! Failure to follow the electrical safety instructions may affect the operating performance and could damage the built-in safety system which, in turn, could result in personal injury or fatality and will invalidate the warranty.**

4.1. WELDING CABLE "ELECTRODE HOLDER" CONNECTION

Before connecting cables it is important to refer to the cable manufacturer's instructions on the electrode packaging which will indicate the correct polarity connection for the electrode, together with the most suitable current to use.

4.1.1. ARC WELDING

In principle, when ARC welding the ELECTRODE HOLDER "POSITIVE" is normally connected to the "POSITIVE" (+) terminal (fig. 2).

4.1.2. TIG WELDING

In principle, when TIG welding alloys, the ELECTRODE HOLDER "POSITIVE" is normally connected to the "NEGATIVE" (-) terminal (fig. 2).

4.2. WELDING "RETURN CABLE" - (WORK CLAMP) CONNECTION

The WORK CLAMP cable is connected to the terminal not occupied by the electrode holder cable. The clamp is connected to:

- a) The workpiece, or
 - b) A metallic work bench. The connection must be as close to the proposed weld as possible.
- ❑ **WARNING! Cable connectors must be turned fully into the quick plugs to ensure a good electrical contact. Loose connections will cause overheating, rapid deterioration and loss in efficiency. DO NOT use welding cables over 10m in length. With the exception of a metallic workbench DO NOT connect the return cable to any metallic structure which is not part of the workpiece, as this will jeopardise weld quality and may be dangerous.**

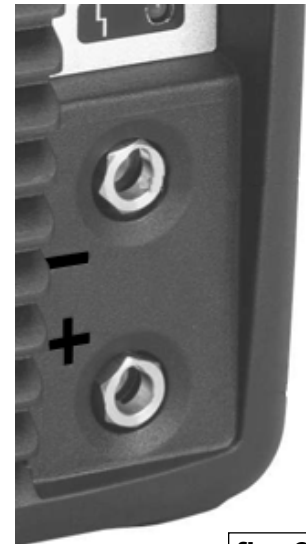
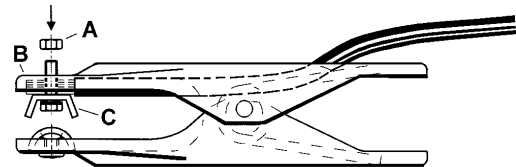

fig. 2

5. CABLE ASSEMBLIES

5.1. Work Clamp

- 5.1.1. Feed the cable through the slot in the work clamp, as shown, and remove the pre-cut section of insulation.
- 5.1.2. Loosen or remove the two nuts 'A' so that the bared end of the cable can be inserted between the clamp jaw 'B' and the copper electrode 'C'.
- 5.1.3. Tighten the nuts 'A' to clamp the cable end.



5.2. Electrode Holder

- 5.2.1. Pull the handle 'A' from the head 'B' and thread the free end of the cable through it, as shown. Remove the pre-cut section of insulation from the cable end.
- 5.2.2. Loosen the clamp screw 'C' and fit the bared cable core under the clamp plate 'D', as shown.
- 5.2.3. Tighten screw 'C' to clamp the cable end.
- 5.2.4. Refit the handle to the head.

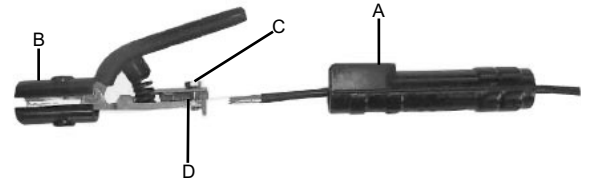

6. WELDING MASK

6.1. Assembly

- 6.1.1. Fold sides and top of mask as shown below and press pins (on edges of top) through holes in top of sides. Ensure that the pins snap fully into the holes. Note that the recess for the filter glass is on the outside.
- 6.1.2. Remove the two screws (2) and the nut (1) from the handle moulding (4).
- 6.1.3. Fit the handle (4) to the front of the mask as shown, and retain with the nut (1).
- 6.1.4. Locate the filter glass (3) in the recess and retain with the two screws (2) - hand tighten only to prevent damage to the plastic threads.

6.2. Use

- 6.2.1. Always hold mask close to the face to provide maximum protection from radiation and droplets of molten metal.
- 6.2.2. Before each use check that the mask is undamaged and that the filter glass is in position and firmly retained. Remove any metal droplets that may be on the glass.

Danger! Never use a filter glass that is chipped, cracked or otherwise faulty as severe eye damage may result.

Warning! Do not allow the mask to come into contact with flame as the fumes produced are harmful.

- 6.2.3. Clean with soapy water, do not use solvents.

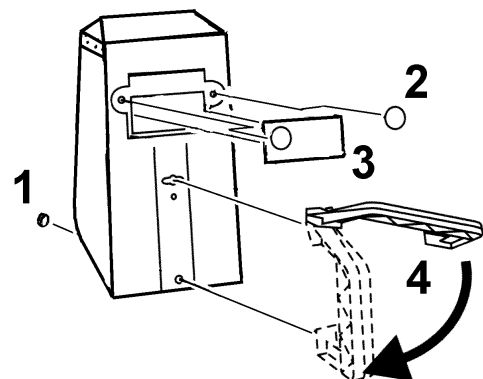
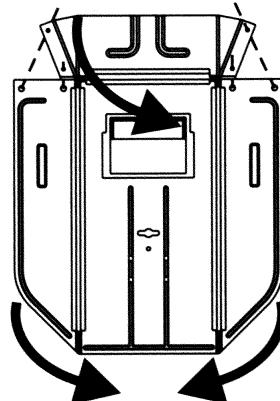

7. CONTROLS

7.1. CONTROLS Figs. 3 & 4

- D. **Rocker switch.** Turns mains power on and off (situated on back panel.)
- E. **Potentiometer.** Regulates welding current with graduated scale in Amps. May be adjusted during welding.
- F. **Green LED.** Mains power indicator, machine ready.
- G. **Yellow LED.** Normally off. 'On' indicates that there is no welding current due to one of the following faults:
 1. Thermal protection: Inside the inverter the temperature is excessive. The machine is ON but does not deliver current until a normal temperature is reached. Once this happens the re-start is automatic.
 2. Mains over/under voltage protection: When the supply voltage is too high (over260Vac) or too low (under 190Vac) the machine is blocked.
 3. Short circuit protection: If there is a short-circuit lasting more than 1.5 secs (i.e. electrode sticking), machine stops. Re-start is automatic.

fig. 3

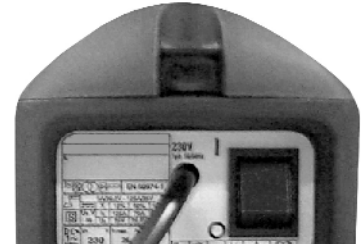

fig. 4



8. PREPARATION

The welding current must be regulated according to the diameter of the electrode in use and the type of joint to be welded. See diameter/current chart to the right.

Further consideration must be given to the location of the weld, for example:

Welds that are performed on a horizontal surface require a higher voltage than those performed on a vertical or overhead surface.

The mechanical character of the weld will be determined not only by the current used, but also by the diameter and quality of the electrode, the length of the arc and the speed and position of the user. The condition of the electrode is an important factor and it must never be wet or damp.

Electrode Diameter (mm)	Welding Current (Amp)	
	Min	Max
1.6	.25	.50
2.0	.40	.80
2.5	.60	.110
3.2	.80	.160
4.0	.120	.200

9. WELDING PROCEDURE

- WARNING! Ensure that you read, understand and follow the safety instructions. Place the welding mask in front of your face before striking the arc.**

9.1. ARC WELDING

9.1.1. Strike the electrode tip on the workpiece as if you were striking a match.

- WARNING! DO NOT hit the electrode on the workpiece, as this may damage the electrode.**

9.1.2. As soon as the arc is struck, maintain a distance from the workpiece equal to the diameter of the electrode. Keep this distance as constant as possible for the duration of the weld. As you advance along the workpiece the angle of the electrode must be maintained at between 20° and 30°.

9.1.3. At the finish of the weld, bring the end of the electrode backward in order to fill the weld crater and then quickly lift the electrode from the weld pool to extinguish the arc.

9.2. TIG WELDING (TIG welding accessory kits available, contact your Sealey dealer)

TIG (tungsten inert gas) shielded welding uses an arc between a tungsten electrode and the work to fuse the joint. The electrode itself is not molten but filler metal is required to build the weld profile. The process is protected from atmospheric contamination by a shield of inert gas. This gas is normally pure argon, but helium, or a mixture of helium and argon, may be used for special applications.

For stainless steel use a mixture of argon and hydrogen.

9.2.1. Strike the electrode tip on the workpiece as if you were striking a match.

- WARNING! DO NOT hit the electrode on the workpiece, as this may damage the electrode.**

9.2.2. Point the electrode in the direction of the weld at about 2.5mm distance from the surface, and use the arc to melt the metal at the joint.

9.2.3. Use the knob on the regulator to increase or decrease the flow of gas.

9.2.4. Filler metal may be added by using cut lengths of wire over 1.5mm diameter (usually 1 metre in length). When using filler metal (for example when making a fillet weld), add the metal to the leading edge of the weld pool.

10. MAINTENANCE

- WARNING! DISCONNECT FROM THE MAINS ELECTRICAL SUPPLY AND WAIT FOR CIRCUIT LIGHT TO GO OUT BEFORE ATTEMPTING TO OPEN THE UNIT.**

Periodically remove the casing and, with a low pressure air flow, remove dust from inside the machine. Ensure that the casing is correctly replaced and secured before attempting to use the inverter.

Keep the outside of the machine clean by wiping with a soft, dry cloth.

For any other service or maintenance, contact your local Sealey service agent.

11. TROUBLESHOOTING

If you have a problem with the inverter, check to ensure that the following are correct:

- Check that the welding current, which is controlled by the potentiometer (fig. 4.E), is suitable for the diameter and type of electrode being used.
- When the mains rocker switch is on, check that the green mains lamp is on. If this is not the case then there may be a mains supply problem.
- Check the yellow LED - has the thermal cut-out activated? This indicates either an over or under voltage or short circuit. If the thermal interrupter has activated, wait for the machine to cool down before restarting.
- Check the normal intermittence ratio is correct, and check that the fan is working correctly.
- Ensure that you are using the correct supply voltage.
- Check the machine output and ensure there is nothing causing a short-circuit.
- Check that all circuit connections are correct. In particular check that the work clamp is correctly attached to the workpiece. Ensure that there is no grease, paint etc. on the surface.

12. RATINGS PLATE

On the rear of the inverter is the ratings plate, giving the following data:

- 1 - The standard relating to the safety and construction of arc welding and associated equipment.
- 2 - Inverter-transformer-rectifier.
- 3 - Welding procedure: manual arc welding with covered electrode.
- 4 - S: Indicates that welding may be carried out in environments with a heightened risk of electric shock e.g. very close to large metallic objects.
- 5 - Power Supply: Single-phase AC.
- 6 - Rating of internal protection provided by casing.
- 7 - Output
 - U₀: Maximum open-circuit voltage.
 - I₂, U₂: Current and corresponding voltage.
 - X: Welding ratio based on a 10 minute cycle. 30% indicates 3 minutes welding and 7 minutes rest, 100% indicates continuous welding.
 - A/V - A/V: Welding current adjustment range and corresponding voltages.
- 8 - Power Supply
 - U₁: Rated supply voltage and frequency.
 - I_{max}: Maximum current.
 - I_{eff}: Maximum effective current.
- 9 - Delayed fuse for supply protection.
- 10 - Symbols referring to safety.
- 11 - Serial Number. Specifically identifies each inverter.

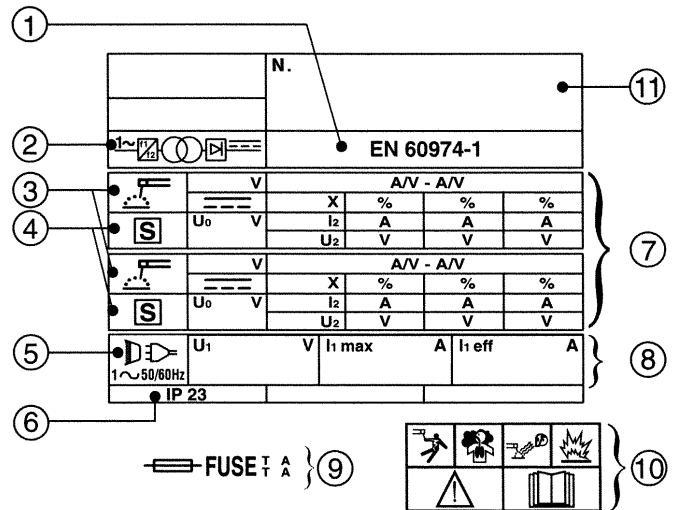

13. ELECTROMAGNETIC COMPATIBILITY

- 13.1. THIS EQUIPMENT IS IN CONFORMITY WITH THE EUROPEAN STANDARD ON THE ELECTROMAGNETIC COMPATIBILITY OF ARC WELDING EQUIPMENT AND SIMILAR PROCESSES (e.g. ARC AND PLASMA CUTTING)
- 13.2. **Protection against interference. (E.M.C.)** The emission limits in this standard may not, however, provide full protection against interference to radio and television reception when the equipment is used closer than 30m to the receiving antenna. In special cases, when highly susceptible apparatus is being used in close proximity, additional mitigation measures may have to be employed in order to reduce the electromagnetic emissions. At the same time there could occur some potential difficulties in having electromagnetic compatibility in a non-industrial environment (e.g. in residential areas). Therefore it is most important that the equipment is used and installed according to the following instructions.
- 13.3. **Installation and use.** The user is responsible for installing and using the equipment according to these instructions. If electromagnetic disturbances are detected, then it shall be the responsibility of the user of the equipment to resolve the situation with the technical assistance of the supplier. In some cases this remedial action may be as simple as earthing the circuit (see Note). In other cases it could involve constructing an electromagnetic screen, enclosing the welding power source and the work, complete with associated input filters. In all cases the electromagnetic disturbances shall be reduced to the point where they are no longer troublesome.

Note: The welding/cutting circuit may or may not be earthed for safety reasons. Changing the earthing arrangements should only be authorised by a person who is competent to assess whether the changes will increase the risk of injury, e.g. by allowing parallel welding/cutting circuit return paths which may damage the earth circuits of other equipment. Further guidance is given in IEC 974-13 'Arc Welding Equipment - Installation and Use.'
- 13.4. **Assessment of area.** Before installing the equipment the user shall make an assessment of potential electromechanical problems in the surrounding area. The size of the surrounding area to be considered will depend on the structure of the building and other activities that are taking place. The surrounding area may extend beyond the boundaries of the premises.

The following shall be taken into account :

 - a) Other supply cables, control cables, signalling and telephone cables, above, below and adjacent to the welding equipment.
 - b) Radio and television transmitters and receivers.
 - c) Computer and other control equipment.
 - d) Safety critical equipment, e.g. security monitoring of industrial equipment.
 - e) The health of people in the vicinity, e.g. persons fitted with a pacemaker or hearing aid.
 - f) Equipment used for calibration or measurement.
 - g) The immunity of other equipment in the environment. The user shall ensure that other equipment being used in the environment is compatible. This may require additional protective measures.
 - h) The time of day that welding and other activities are to be carried out.
- 13.5. **Mains supply.** The equipment should be connected to the mains supply according to these instructions. If interference occurs, it may be necessary to take additional precautions such as filtering of the mains supply. Consideration should also be given to shielding the supply cable of permanently installed equipment in metallic conduit or equivalent. This shielding should be connected to the power source so that good electrical contact is maintained between the conduit and the welding power source enclosure.
- 13.6. **Maintenance of the equipment.** The equipment should be routinely maintained according to these instructions. All access and service covers should be closed and properly fastened when the welding equipment is in operation. The welding equipment should not be modified in any way except for those changes and adjustments covered in these instructions. In particular, the spark gaps of any arc striking and stabilising devices should be adjusted and maintained according to the instructions.
- 13.7. **Cables.** The welding/cutting cables should be kept as short as possible and should be positioned close together, running at or close to the floor level.
- 13.8. **Equipotential bonding.** Bonding of all metallic components in the welding/cutting installation and adjacent to it should be considered. However, metallic components bonded to the workpiece will increase the risk that the operator could receive a shock by touching these metallic components and the electrode at the same time. The operator should be insulated from all such bonded metallic components.

- 13.9. **Earthing of the workpiece.** Where the workpiece is not bonded to earth for electrical safety, nor connected to earth because of its size and position, e.g. ship's hull or building steelwork, a connection bonding the workpiece to earth may reduce emissions in some, but not all instances. Care should be taken to prevent the earthing of the workpiece increasing the risk of injury to others or damage to other electrical equipment. Where necessary, the connection of the workpiece to earth should be made by a direct connection to the workpiece, but in some countries where direct connection is not permitted, the bonding should be achieved by a suitable capacitance, selected according to national regulations.
- 13.10. **Screening and shielding.** Selective screening and shielding of other cables and equipment in the surrounding area may alleviate problems of interference. Screening of the entire welding/cutting installation may be considered for special applications.

14. DECLARATION OF CONFORMITY

Declaration of Conformity We, the sole importer into the UK, declare that the products listed below are in conformity with the following standards and directives.

INVERTERS

Models MW100.V2 & MW130.V2

73/23/EEC Low Voltage Directive

89/336/EEC EMC Directive

93/68/EEC CE Marking Directive



The construction files for these products are held by the Manufacturer and may be inspected, by a national authority, upon request to Jack Sealey Ltd.

Signed by Mark Sweetman

6th March 2003

For Jack Sealey Ltd. Sole importer into the UK of Sealey Power Welders.



NOTE: It is our policy to continually improve products and as such we reserve the right to alter data, specifications and component parts without prior notice.

IMPORTANT: No liability is accepted for incorrect use of this equipment.

WARRANTY: Guarantee is 12 months from purchase date, proof of which will be required for any claim.

INFORMATION: For a copy of our latest catalogue and promotions call us on 01284 757525 and leave your full name and address, including postcode.

SEALEY POWER WELDERS

Sole UK Distributor,
Sealey Group,
Bury St. Edmunds, Suffolk.

01284 757500

01284 703534

e-mail sales@sealey.co.uk

www.sealey.co.uk