

Thank you for purchasing a Sealey product. Manufactured to a high standard this product will, if used according to these instructions and properly maintained, give you years of trouble free performance.



IMPORTANT: PLEASE READ THESE INSTRUCTIONS CAREFULLY. NOTE THE SAFE OPERATIONAL REQUIREMENTS, WARNINGS & CAUTIONS. USE THE PRODUCT CORRECTLY AND WITH CARE FOR THE PURPOSE FOR WHICH IT IS INTENDED. FAILURE TO DO SO MAY CAUSE DAMAGE AND/OR PERSONAL INJURY AND WILL INVALIDATE THE WARRANTY. PLEASE KEEP INSTRUCTIONS SAFE FOR FUTURE USE.

1. SAFETY INSTRUCTIONS

1.1 ELECTRICAL SAFETY

- WARNING!** It is the responsibility of the owner and the operator to read, understand and comply with the following: You must check all electrical products, before use, to ensure that they are safe. You must inspect power cables, plugs, sockets and any other connectors for wear or damage. You must ensure that the risk of electric shock is minimised by the installation of appropriate safety devices. A Residual Current Circuit Breaker (RCCB) should be incorporated in the main distribution board. We also recommend that a Residual Current Device (RCD) is used. It is particularly important to use an RCD with portable products that are plugged into a supply which is not protected by an RCCB. If in any doubt consult a qualified electrician. You may obtain a Residual Current Device by contacting your Sealey dealer.
You must also read and understand the following instructions concerning electrical safety.
 - 1.1.1 The Electricity at Work Act 1989 requires that all portable electrical appliances, if used on business premises, are tested by a qualified electrician, using a Portable Appliance Tester (PAT), at least once a year.
 - 1.1.2 The Health & Safety at Work Act 1974 makes owners of electrical appliances responsible for the safe condition of those appliances and the safety of the appliance operators. If in any doubt about electrical safety, contact a qualified electrician.
 - 1.1.3 Ensure that the insulation on all cables and on the appliance is safe before connecting it to the power supply. See 1.1.1. and 1.1.2. and use a Portable Appliance Tester.
 - 1.1.4 Ensure that cables are always protected against short circuit and overload.
 - 1.1.5 Regularly inspect power supply cables and plugs for wear or damage and check all connections to ensure that none is loose.
 - 1.1.6 Important: Ensure that the voltage marked on the appliance matches the power supply to be used and that the plug is fitted with the correct fuse - see fuse rating at right.
 - 1.1.7 **DO NOT** pull or carry the appliance by the power cable.
 - 1.1.8 **DO NOT** pull the plug from the socket by the cable.
 - 1.1.9 **DO NOT** use worn or damaged cables, plugs or connectors. Immediately have any faulty item repaired or replaced by a qualified electrician. When a BS 1363/A UK 3 pin plug is damaged, cut the cable just above the plug and dispose of the plug safely.
Fit a new plug according to the following instructions (UK only).
 - a) Connect the GREEN/YELLOW earth wire to the earth terminal 'E'.
 - b) Connect the BROWN live wire to the live terminal 'L'.
 - c) Connect the BLUE neutral wire to the neutral terminal 'N'.
 - d) After wiring, check that there are no bare wires, that all wires have been correctly connected, that the cable outer insulation extends beyond the cable restraint and that the restraint is tight.
- Double insulated** products, which are always marked with this symbol , are fitted with live (brown) and neutral (blue) wires only. To rewire, connect the wires as indicated above - **DO NOT connect either wire to the earth terminal.**
- 1.1.10 Products which require more than 13 amps are supplied without a plug. In this case you must contact a qualified electrician to ensure that a suitably rated supply is available. We recommend that you discuss the installation of an industrial round pin plug and socket with your electrician.
 - 1.1.11 If an extension reel is used it should be fully unwound before connection. A reel with an RCD fitted is preferred since any appliance plugged into it will be protected. The cable core section is important and should be at least 1.5mm², but to be absolutely sure that the capacity of the reel is suitable for this product and for others which may be used in the other output sockets, we recommend the use of 2.5mm² section cable.

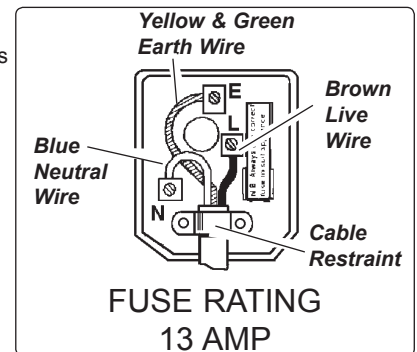

1.2 GENERAL SAFETY

- WARNING!** Disconnect the saw from the mains power, and ensure that the cutting disc is at a complete standstill before attempting to change accessories, service or perform any maintenance.
- ✓ Maintain the saw in good condition (use an authorised service agent).
- ✓ Replace or repair damaged parts. Use recommended parts only. Unauthorised parts may be dangerous and will invalidate the warranty.
- ✓ Locate the saw in a suitable work area. Ensure that the surface is flat and firm. Keep the area clean and tidy and free from unrelated materials, and ensure that there is adequate lighting.
- ✓ Keep the saw clean for best and safest performance and check moving parts alignment regularly.
- WARNING!** Before each use check that the cutting disc is secure and that it is not worn or damaged.
NOTE: Only persons qualified under the "Abrasive Wheels Regulations" holding a current grinding wheel certificate may change discs (wheels).
- ✓ Ensure that replacement discs are not damaged in any way - cracks, deformations or splinters etc. Also check the mounting flanges to ensure that they are not deformed, burred or chipped. Damaged flanges must not be used as they may cause uneven pressure on the disc which may cause the disc to break. **DO NOT** over tighten a disc and never tamper with a disc in order to adapt it to a different size holder.
- ✓ Always use a disc suitable for the material being cut. Ensure that the cutting discs specified maximum speed is equal to, or higher than, that indicated on the machine data plate. Once mounted on the saw, test the disc before use by facing the grinder in a safe direction (point disc away from yourself, others and vulnerable items) and running it for a short time.
- WARNING!** Keep guard and holding screws in place, tight and in good working order. Check regularly for damaged parts. A guard or any other part that is damaged must be repaired or replaced before next use. The safety guard is a mandatory fitting when the saw is used on premises covered by the Health & Safety at Work Act.
- ✓ Remove adjusting keys and wrenches from the machine and its vicinity before turning it on.

- ❑ **WARNING!** Wear approved safety eye protection, ear defenders, gauntlets and, if dust is generated, respiratory protection.
- ✓ Remove ill fitting clothing. Remove ties, watches, rings and other loose jewellery and contain long hair.
- ✓ Keep hands and body clear of the worktable when operating the saw, and **DO NOT** position your body in line with the abrasive wheel.
- ✓ Maintain correct balance and footing. Ensure the floor is not slippery and wear non-slip shoes.
- ✓ Keep children and unauthorised persons away from the work area.
- ✓ Avoid subjecting disc to excessive strain, always ease disc down against workpiece (a harsh downward impact may break the disc). Do not apply undue force on the handle in order to cut workpiece. Maintain a controlled cutting speed through the workpiece.
- ❑ **WARNING!** **DO NOT** switch on the saw whilst the disc is in contact with the workpiece. Bring the rotating disc to the workpiece. Avoid un-intentional starting of the saw.
- x **DO NOT** hold the workpiece by hand. Use base vice to secure the workpiece.
- x **DO NOT** use the saw for a task it is not designed to perform.
- x **DO NOT** allow untrained persons to operate the saw.
- x **DO NOT** get the saw wet, or use in damp or wet locations or areas where there is condensation.
- ❑ **WARNING!** **DO NOT** use the saw where there are flammable liquids, solids or gases such as paint solvents and including waste wiping rags etc.
- x **DO NOT** operate the saw if any parts are missing or damaged as this may cause failure and/or personal injury.
- x **DO NOT** remove the safety guard whilst the saw is in use.
- x **DO NOT** attempt to remove a workpiece until the disc has stopped rotating.
- x **DO NOT** touch the workpiece close to the cut as it will be very hot. Allow to cool. The cut edge of the workpiece will also be very sharp.
- x **DO NOT** leave the saw operating unattended.
- x **DO NOT** operate the saw when you are tired or under the influence of alcohol, drugs or intoxicating medication.
- ✓ When not in use switch off the saw and remove the plug from the power supply.
- ✓ To move the saw, lock the machine head with the locking plate and lift by the handle.

2. SPECIFICATIONS

General purpose abrasive saw. Supplied with abrasive disc suitable for metal-cutting but will cut concrete with correct blade fitted.

Specifications:

Size of disc	Ø355 x 3 x 25.4mm	Cutting capacity @ 45°(bar)	Ø40mm	No-load speed	3750rpm
Disc Part No.	PTC/355C	Cutting capacity @ 45°(pipe)	Ø50mm	Mitre angles	0 - 45°
Cutting capacity @ 90°(bar)	Ø100mm	Motor	2200W - 230V	Net Weight	19.8kg
Cutting capacity @ 90°(pipe)	Ø110mm	Double Insulated	Class II	Sound power level	111dB

3. CONTENTS

Unpack the product and check the contents. Ensure that there is no damage. If any problem is noted, contact your supplier immediately.

IMPORTANT: Abrasive disc MUST only be fitted by a qualified person.

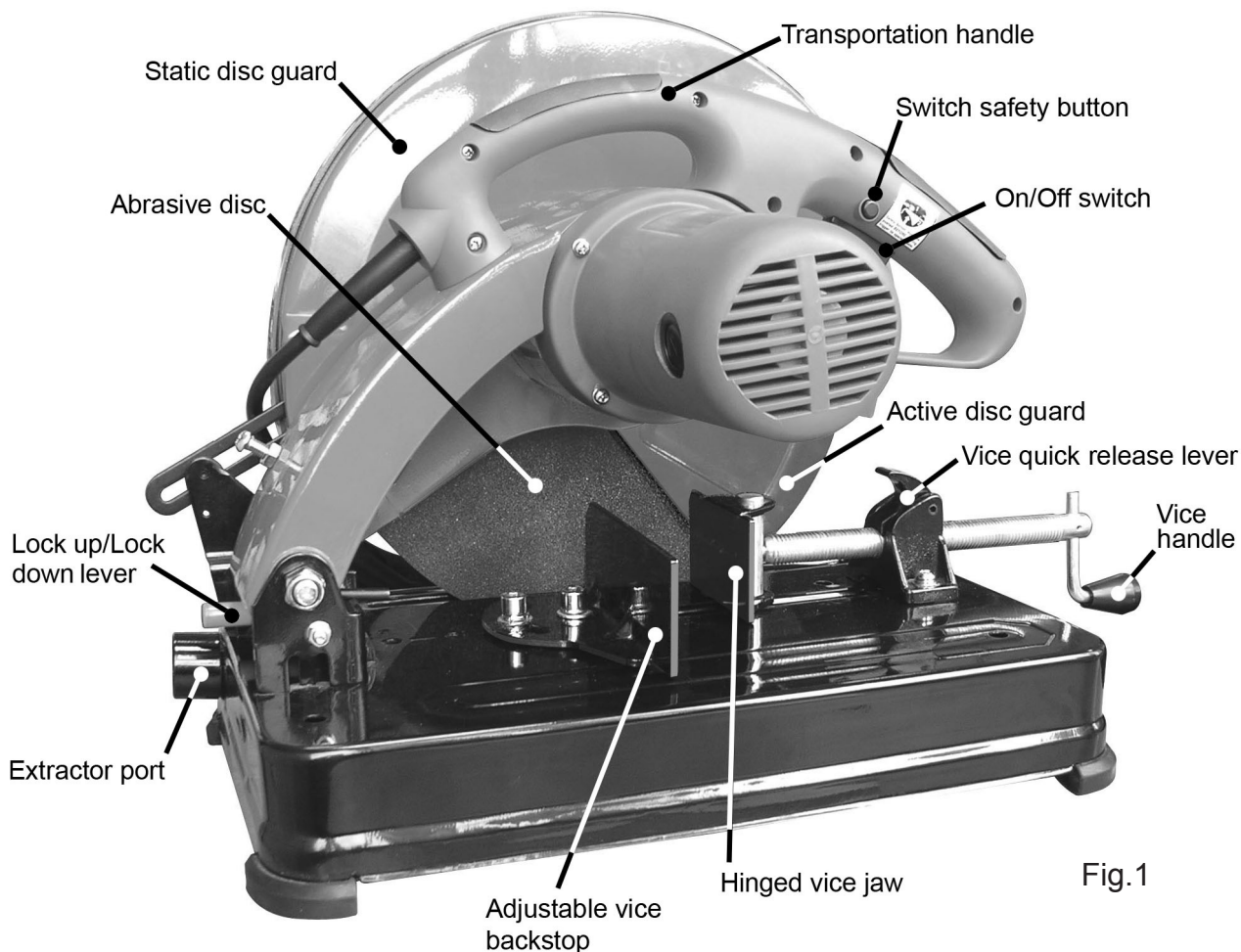
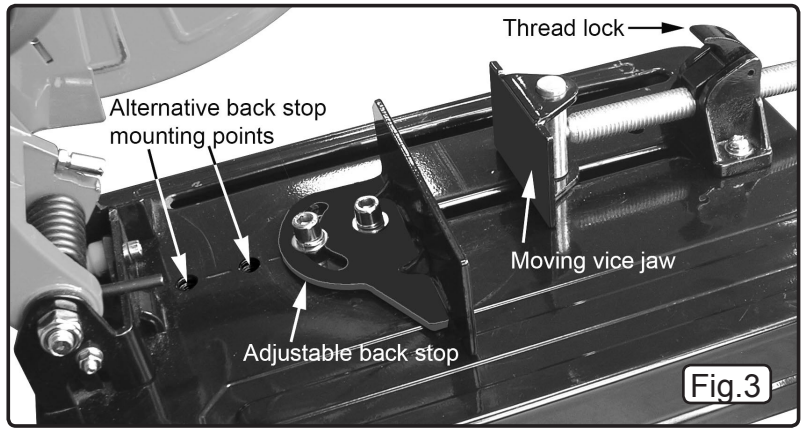
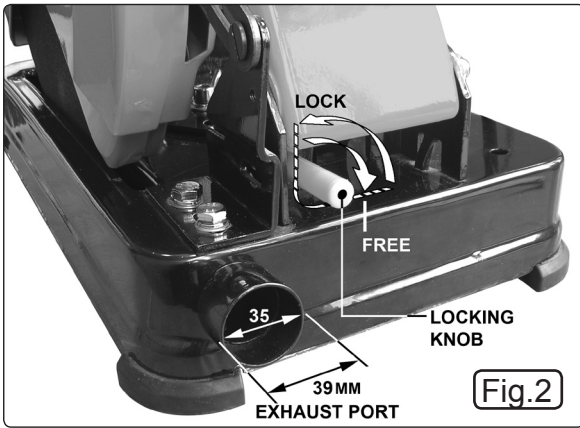

Fig.1

4. OPERATING INSTRUCTIONS



- ❑ **WARNING! Before cutting ensure that you wear approved safety goggles, ear defenders, appropriate dust mask if cutting generates dust, and safety gloves. All safety instructions in Section 1 must be followed.**

4.1 USING THE LOCKING KNOB. (Refer to Fig.2)

- 4.1.1 When not in use or when being transported the cutting arm should always be locked down. To lock the arm down, pull it to its lowest position against the return spring pressure until it is solidly against the stop. Hold it in this position and rotate the locking knob on the front of the machine anti-clockwise through 90°. When the arm is released it will move up slightly. To release the arm, push it down against the stop and hold it there. Rotate the locking knob clockwise through 90° to free it and hold onto the operating handle whilst the arm rises. If necessary the arm can be locked in the up position by rotating the knob back to the locked position.

4.2 DUST EXTRACTION. (Refer to Fig.2)

- 4.2.1 The MG314 cut off saw comes with a dust extraction port, situated at the rear of the cutting table.
- 4.2.2 Attach dust extraction pipe (not included) to the port (See internal and external dimensions in Fig.2).
- 4.3.3 Activate dust extractor (not included), then activate cut off saw.

4.3 SECURING THE WORKPIECE.

- 4.3.1 **Ensure that the saw is unplugged from the power supply.**
- 4.3.2 Check that the back stop is at 90° to the abrasive disc using a set square. Ensure the back stop fixings are tight using the hex key provided.
- 4.3.3 To move the other jaw up to the workpiece quickly, flip the thread lock open as shown in Fig.6 and slide the jaw face up to the workpiece. Flip the thread lock back down and tighten the workpiece in the vice.
- 4.3.4 For additional cutting capacity relocate the back stop (Fig.3) in the alternative mounting holes indicated and fully secure.
- 4.3.5 When cutting long workpieces use additional supports along the length.

4.4 CUTTING DEPTH

- 4.4.1 As the abrasive disc begins to wear down during use it may be necessary to adjust the cutting depth. (See depth stop in Fig.5) Only a small movement of the depth stop is required to increase/decrease the depth. There is a close relationship between the locking knob and the depth stop. After adjusting the depth stop check that the locking knob still functions correctly.

4.5 MITRE CUTTING

- 4.5.1 To cut at an angle loosen the two hex cap bolts on the back stop with the hex key provided and rotate the back stop to the required angle using the graduated scale stamped on the back edge of the back stop. Align the required angle with the index line on the base plate as shown in Fig.4. and tighten down the back stop fixings. Place the workpiece against the back stop and move the other jaw up to it and securely tighten.

4.6 ON/OFF SWITCH

- 4.6.1 The On/Off switch is locked in the Off position. To turn On the saw you must press in the safety button with your thumb before pulling the switch upwards. The switch is spring loaded and must be held in the up position in order for the saw to continue running. As soon as the pressure on the switch is released the saw will turn off.

4.7 OPERATION

- ❑ **WARNING! DO NOT switch on the saw whilst the disc is in contact with the workpiece. Bring the rotating disc to the workpiece.**
- 4.7.1 The cutting disc must be running at maximum speed before attempting to lower the cutting edge onto the workpiece.
- 4.7.2 Lower the cutting disc slowly and smoothly down towards the workpiece (avoid jerky movements).
- 4.7.3 Avoid subjecting the disc to excessive strain. Always ease the disc down against the workpiece (a harsh downward impact may cause disc failure) and do not apply undue force on the handle when cutting the workpiece. Maintain a controlled cutting speed.
- 4.7.4 When cutting is complete, fully raise the cutting disc and release the On/Off switch.
- 4.7.5 Wait until the disc has stopped rotating before attempting to remove the workpiece.

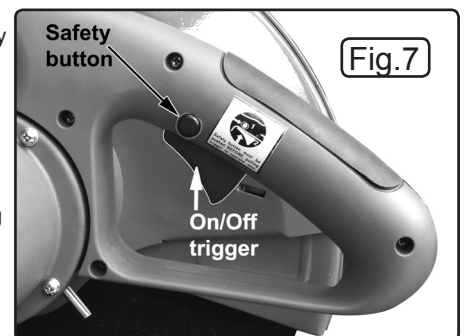
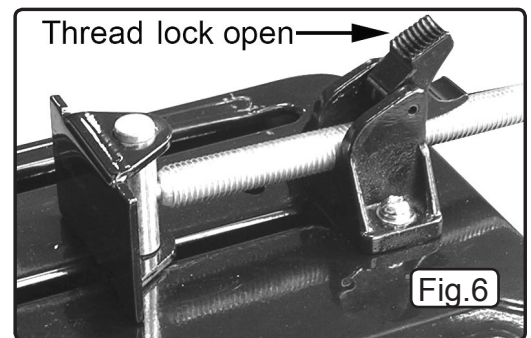
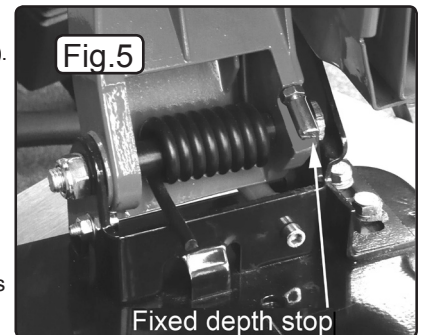
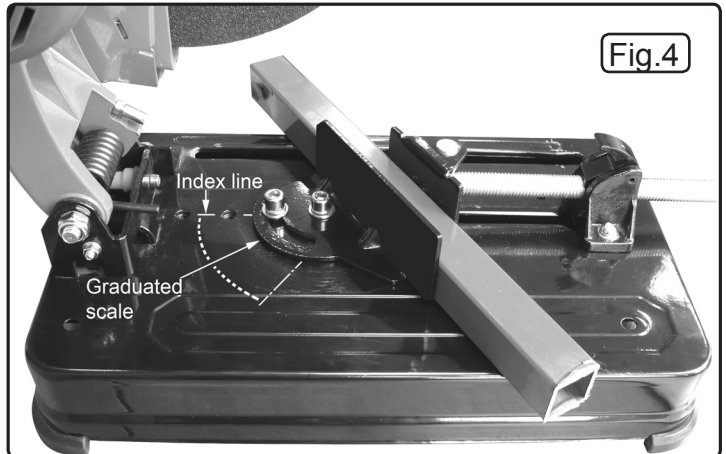

5. CHANGING CUTTING DISC

- ▲ **DANGER!** The use of damaged discs is dangerous and may cause injury.
- **WARNING!** Ensure that the saw is unplugged from the power supply before attempting to change the cutting disc.
- 5.1 **IMPORTANT!** Cutting discs used with this machine must be of an adequate speed rating and suitable for the task in hand. (See specification). Only persons qualified under the "Abrasive Wheels Regulations" and holding a current grinding wheel certificate are to change cutting discs.
- 5.1.1 Before using a cutting disc ensure that there are no fissures or cracks in it. Once mounted on the saw, test the disc before use by facing the saw in a safe direction (turned away from yourself, others and vulnerable items) and run it for a short time.

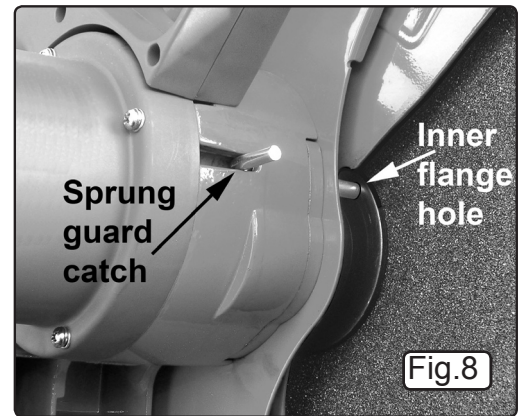

5.2. REMOVING AND INSTALLING CUTTING DISCS

- 5.2.1 Release the arm as described in 4.1.1. (Remember to hold the arm as it rises).
- 5.2.2 Identify the spring loaded guard catch as shown in Fig.8.
- 5.2.3 Manually open the moving disc guard and hold it in the open position whilst moving the spring loaded catch to the right. Rotate the abrasive disc until you can see a hole in the inner mounting flange. Align this hole with the sprung guard catch and slide the catch over until it is fully inserted into the hole. (See Fig.8). Keep finger pressure on the catch and slowly lower the guard until it rests on the catch pin. Let go of the guard before letting go of the catch.

- 5.2.4 Loosen the two fixing bolts as shown in Fig.9. The access cover is held under the bolts by a keyhole arrangement. Slide the cover towards the centre of the wheel and lift it off to reveal the wheel fixing.
- 5.2.5 Using the 8mm Hex key provided remove the disc fixing bolt, the clamping washer and the front mounting flange as shown in Fig.10. Finally remove the disc from the boss.
- 5.2.6 Place the new disc over the central boss on the rear flange. Place the front flange onto the raised spigot ensuring that the flats on the flange are aligned with the flats on the spigot. Retain the assembly with the clamping washer and centre bolt. Do not over tighten the centre bolt.

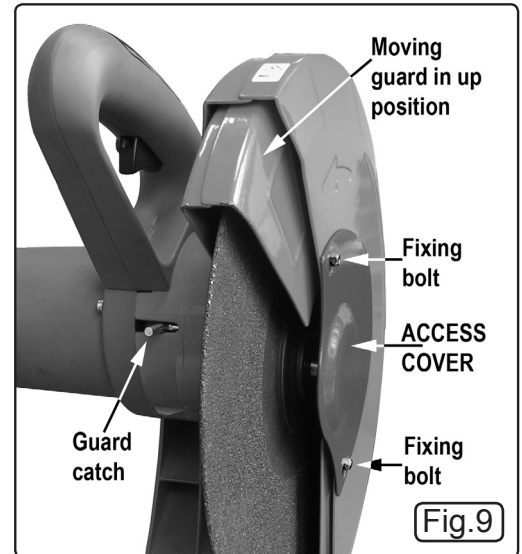
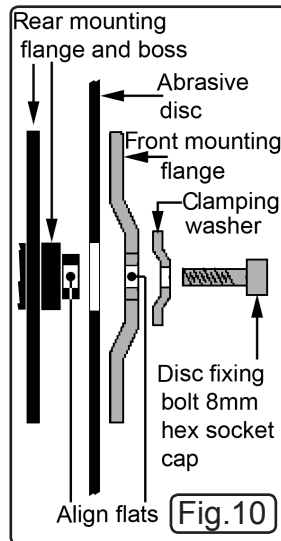

6. MAINTENANCE

- **WARNING!** Ensure that the saw is unplugged from the power supply before attempting any maintenance.
- 6.1 Regularly clean the dust which accumulates inside the protective guard and on the external parts.
- 6.2 Periodically clean and oil the vice screw.
- 6.3 Change the abrasive disc when it is worn and/or does not operate efficiently.
- 6.4 Before each use, check for obvious signs of damage to the machine. Also check for loose screws and other moving parts, incorrectly mounted or misaligned parts and any other factors that might create an unsafe working environment.

- **WARNING!** Should excessive noise or vibration occur, cease use immediately. Turn off the machine and disconnect from power supply. Do not use the machine again until the problem has been fully resolved.

6.5. CHANGING THE MOTOR BRUSHES.

- The motor brushes should be checked periodically for wear and renewed when worn down or pitted. The brushes can be accessed either side of the motor casing as seen in Fig.11.
- 6.5.1 Unscrew the plastic covers and withdraw the brush assemblies for inspection as shown in Fig.12.
- 6.5.2 Insert the new brush (B) into the keyway (A). Place the plastic cap over the head of the brush assembly and press the spring downwards ensuring that the tabs (C) on either side of the brush head enter the same keyway as the brush. Screw the caps back into position.

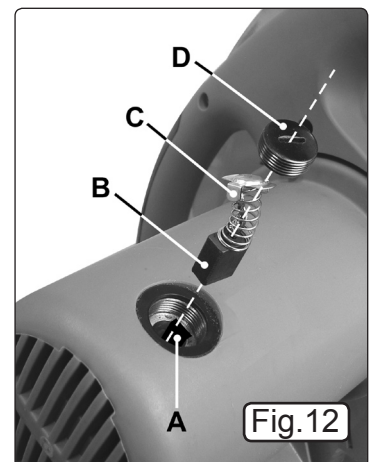
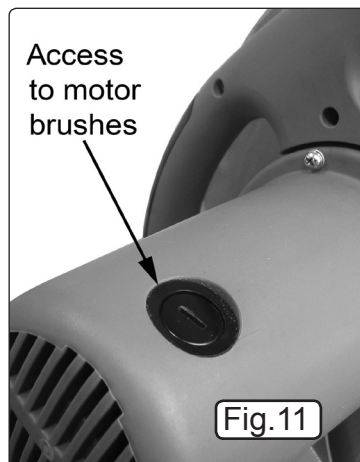

NOTE: It is our policy to continually improve products and as such we reserve the right to alter data, specifications and component parts without prior notice.

IMPORTANT: No liability is accepted for incorrect use of this product.

WARRANTY: Guarantee is 12 months from purchase date, proof of which will be required for any claim.

INFORMATION: For a copy of our latest catalogue and promotions call us on 01284 757525 and leave your full name and address, including postcode.



Sole UK Distributor, Sealey Group,
Kempson Way, Suffolk Business Park,
Bury St. Edmunds, Suffolk,
IP32 7AR

01284 757500

www.sealey.co.uk

01284 703534

sales@sealey.co.uk