



# INDUSTRIAL INFRARED DIESEL HEATERS

MODEL NO: IR13.V2, IR16.V2

Thank you for purchasing a Sealey product. Manufactured to a high standard, this product will, if used according to these instructions, and properly maintained, give you years of trouble free performance.

**IMPORTANT:** PLEASE READ THESE INSTRUCTIONS CAREFULLY. NOTE THE SAFE OPERATIONAL REQUIREMENTS, WARNINGS & CAUTIONS. USE THE PRODUCT CORRECTLY AND WITH CARE FOR THE PURPOSE FOR WHICH IT IS INTENDED. FAILURE TO DO SO MAY CAUSE DAMAGE AND/OR PERSONAL INJURY AND WILL INVALIDATE THE WARRANTY. KEEP THESE INSTRUCTIONS SAFE FOR FUTURE USE.



Refer to instructions



Wear protective gloves



Always unplug before servicing and checking



Warning: Hot surfaces



Do not cover



Keep in dry area protect from rain



Use in well ventilated areas

**DANGER**

## 1. SAFETY

### 1.1. ELECTRICAL SAFETY

- WARNING!** It is the user's responsibility to check the following:
- ✓ Check all electrical equipment and appliances to ensure that they are safe before using. Inspect power supply leads, plugs and all electrical connections for wear and damage. Sealey recommend that an RCD (Residual Current Device) is used with all electrical products.

**Electrical safety information.** It is important that the following information is read and understood:

- ✓ Ensure that the insulation on all cables and on the appliance is safe before connecting it to the power supply.
  - ✓ Regularly inspect power supply cables and plugs for wear or damage and check all connections to ensure that they are secure.
  - Important:** Ensure that the voltage rating on the appliance suits the power supply to be used and that the plug is fitted with the correct fuse.
  - ✗ **DO NOT** pull or carry the appliance by the power cable.
  - ✗ **DO NOT** pull the plug from the socket by the cable.
  - ✗ **DO NOT** use worn or damaged cables, plugs or connectors. Ensure that any faulty item is repaired or is replaced immediately by a qualified electrician.
- If the cable or plug is damaged during use, switch off the electricity supply and remove from use.

- Ensure that repairs are carried out by a qualified electrician.**

### GENERAL SAFETY

- WARNING! THIS HEATER IS FOR PROFESSIONAL USE. IT HAS BEEN CAREFULLY DESIGNED FOR MOBILE AND TEMPORARY PROFESSIONAL APPLICATIONS. IT HAS NOT BEEN DESIGNED FOR DOMESTIC USE NOR FOR COMFORT HEATING AND SHOULD NEVER BE USED TO HEAT CLOSED ROOMS WITHOUT ADEQUATE VENTILATION.**
- ▲ **DANGER!** Risk of carbon monoxide poisoning. Failure to provide proper ventilation could result in serious illness or death.
- ✓ Check that the heater is in sound condition and good working order. Take immediate action to repair or replace damaged parts.
- ✓ Use recommended parts only. Unauthorised parts may be dangerous and will invalidate the warranty.
- ✓ Only use diesel or kerosene to fuel this heater, in accordance with instructions contained in this manual.
- ✓ Locate heater on a level and stable surface.
- WARNING!** Only use heater in well ventilated areas. Ensure continuous ventilation is provided to the heater operating area via windows and doors etc. If people are not required to be present in the heated area, the volume of air to be heated (m<sup>3</sup>)/heat output (kW) ratio must be at least 10:1 and people must be advised not to remain in the heated area for prolonged periods. If people are required to be present in the heated area, the volume of air to be heated (m<sup>3</sup>)/heat output (kW) ratio must be at least 30:1. Ventilation must be to the outside of the premises in which the heater is to be operated. The total open area (m<sup>2</sup>) must be at least 0.003 times the total heat output (kW). The volume concentration of oxygen (O<sub>2</sub>) in the heated room, must always remain above 17%.
- WARNING! DO NOT** use the heater near flammable material, liquids, solids, gases or compressed gas cylinders etc.
- ✗ **DO NOT** stand or place any object less than 3m from the heater output and keep the heater a minimum of 2m from any walls or objects.
- ✗ **DO NOT** use the heater in closed rooms, living areas, basements or below ground level.
- ✗ **DO NOT** allow untrained persons to operate the heater and **DO NOT** operate the heater without the safety guard.
- ✗ **DO NOT** move or handle the heater when hot, without wearing protective gloves. Never move the heater whilst it is operating.
- ✗ **DO NOT** leave the heater unattended for prolonged periods of time when in use. Switch the heater off and unplug from the mains before leaving work area.
- ✗ **DO NOT** fill the fuel tank whilst the heater is running or still hot. **DO NOT** over-fill the fuel container. Wipe up any spilt fuel immediately.
- ✗ **DO NOT** obstruct the air inlet (rear) and air outlet (front) of the heater and **DO NOT** use duct work in front or at the rear of the heater.
- ✗ **DO NOT** allow children or animals near the heater when in use, or whilst still hot.
- WARNING! RISK OF ELECTRIC SHOCK. DO NOT** expose the heater to water spray, rain, dripping water or wind.
- ✗ **DO NOT** operate the heater when you are tired or under the influence of alcohol, drugs or intoxicating medication.
- ✗ **DO NOT** touch the heater outlet or cone when in use, or for a period of time after it's switched off, as these are VERY hot and will take time to cool down.

- ✗ **DO NOT** switch the heater off by disconnecting it from the mains. ALWAYS set the switch on the burner to the 'OFF' position and allow the cooling cycle to finish, before disconnecting from the mains.
  - ✗ **DO NOT** use an external fuel tank. Only use the tank that is fitted to the heater, and only fill it when the heater has cooled down.
  - ✗ **DO NOT** use "old" or "second-hand" diesel or anything other than clean, fresh, new diesel.
  - ✗ **DO NOT** use low-quality diesel. Always use high-quality and clean fuel that has been filtered before use. Using any other type of fuel will invalidate the warranty and could cause an explosion, a fire or the unit to malfunction.
  - ✓ Ensure that the heater is correctly turned off.
  - ✓ When not in use for an extended period, store in a safe, dry area, out of reach of children.
- IMPORTANT:** This appliance is not intended for persons (including children) with reduced physical, sensory or mental capabilities, or lack of experience and knowledge, unless they have been given supervision or instruction concerning use of the appliance by a person responsible for their safety. Children should be supervised to ensure that they **DO NOT** play with the appliance.
- ✓ Only suitable for clean, fresh, filtered diesel.

## 2. INTRODUCTION

Versatile and compact diesel-fuelled Infrared technology heater has no electric fan, meaning there is no air movement and the heat is spread evenly in all directions, quietly and dust-free. Ideal for use in well-ventilated indoor areas including garages, workshops, warehouses and marquees. Extremely inexpensive to run, using only around 1L of fuel per hour. Clean burn and precisely controlled fuel supply, ensure that no unpleasant odours or carbon monoxide enter the air. Equipped with advanced safety features including overheat protection, auto-misfire, tilt, shock, low fuel shut-off sensors and flame-out fuel cut. Features 24hr timer and temperature control thermostat. Soft-touch control panel with LED display. Fitted with four castor wheels for easy manoeuvrability. Stainless exhaust available - IREX1 (End Pipe), IREX2 (1m Extension), IREX3 (90° Bend). Only suitable for use with fresh, clean diesel. The use of any other fuels or old/second-hand diesel will invalidate the warranty and may cause the unit to malfunction.

## 3. SPECIFICATION

<b>Models No's:</b>	<b>IR13.V2 IR16.V2</b>
Electrical Plug Type:	3-Pin BS
Fuel Tank	50L
Fuel	Diesel
Output:	44,500btu/hr (13kW) / 55,000btu/hr (16kW)
Heated Area (IR13/IR16):	11,477ft <sup>3</sup> (325m <sup>3</sup> ) /14,125ft <sup>3</sup> (400m <sup>3</sup> )
Running Time per Filling (Maximum):	(IR13/IR16). 52hr / 42hr
Supply:	230V~50Hz
Transport Wheels:	Yes

	<b>IR13.V2</b>	<b>IR16.V2</b>
Power:	80W	80W
Noise Level:	45dB(A)	48dB(A)
Energy Efficiency Class:	A	A
Nominal Heat Output:	13kW	16kW
Energy Efficiency Index:	91%	92%
Useful Energy Efficiency at Nominal Heat Output: $\eta$ (nom):	91%	92%

**NOTE:** There should be no combustible objects within 2 metres in front of the heater, within 1.5 metres of the top, and no combustible objects or shielding objects within 0.5 metres to the left, right and rear side.



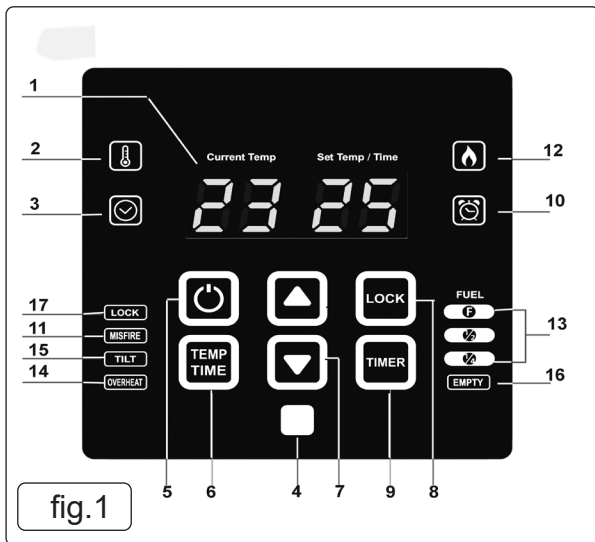

ITEM	DESCRIPTION
1	LED Display for Current Temp/Set Temp-Time
2	Temperature Control Mode On
3	Cycle Time Control Mode On
4	(IR Receiver NOT FITTED TO THIS MODEL)
5	ON/OFF
6	Temp / Cycle Time Selection
7	Increase/Decrease Temp or Cycle Time Setting
8	Lock Settings - press to lock, press to unlock
9	Timer ON/OFF
10	Timer ON Indicator
11	Misfire Indicator
12	Operating Indicator
13	Fuel Gauge Display
14	Overheating Indicator
15	Tilt Indicator
16	Low/Empty fuel Indicator
17	Lock State Indicator

## 4. OPERATION

4.1. Connect the unit to the power supply and turn it on.

4.1.1. The LED displays the current ambient temperature.

### 4.2. TEMPERATURE CONTROL



**NOTE:** Temperature is displayed in degrees centigrade. To change to Fahrenheit hold both UP and DOWN arrows for 5 seconds.

4.2.1. Switch the unit on (fig.1.5).  The heater will start up using the last entered values of temperature and time. The unit can be Switched off by pressing the ON/OFF button again (fig.1.5). 

4.2.2. To set the required temperature, use the UP and DOWN arrows (fig.1.7). The temperature setting range is from 0° to 40° C.

**NOTE:** If the set temperature is 2°C higher than current ambient temperature the unit will start working. If set temperature is 1°C below current ambient temperature, the unit will stop working.

### 4.3. CYCLE TIME CONTROL

4.3.1. Switch the unit on (fig.1.5).  The heater will start up using the last entered values of temperature and time. The unit can be Switched off by pressing the ON/OFF button again (fig.1.5). 

4.3.2. Press Temp/Time selector (fig.1.6 ) and wait a few seconds until Cycle Timer ON indicator (fig.1.3 ) is illuminated.

4.3.3. To set ON cycle time period, use the UP and DOWN arrows (fig.1.7). Once set to the required value, stop pressing buttons and after 3 seconds the displayed value will be set.

4.3.4. The cycle time ON value can be set from 5 minutes up to 55 minutes.

**NOTE:** If the inputted value exceeds 55 minutes, the unit will operate in continuous mode and displays 

### 4.4. TIMER

4.4.1. To run for a set time, select the TIMER function (fig.1.9 ) and use the UP and DOWN arrows (fig.1.7) to set time.

The Timer ON indicator (fig.1.10 ) will illuminate.

4.4.2. Long press the timer button (fig.1.8 ) for 3 seconds to turn off the timer.

### 4.5. CHILD LOCK

4.5.1. Press the child lock button (fig.1.7 ) for 3 seconds to turn on or turn off the child lock function.

**NOTE:** There should be no combustible objects within 2 metres in front of the heater, within 1.5 metres of the top, and no combustible objects or shielding objects within 0.5 metres to the left, right and rear side.

## 5. MAINTENANCE

- ❑ **WARNING!** Unplug unit from mains power supply ensure heater is cold before opening or servicing heater.
- ❑ **WARNING! DO NOT** tamper with the unit, have an experienced service engineer make any necessary adjustment or repairs.

### 5.1. LONG TERM STORAGE

- 5.1.1. Unscrew the fuel cap.
- 5.1.2. Using an approved siphon, remove the diesel.
- 5.1.3. Using a small amount of diesel, rinse and swirl the fuel inside the fuel tank.
- 5.1.4. Empty the tank completely.

**NOTE:** never mix water with fuel, it will cause rust inside the tank.

**IMPORTANT:** Never store leftover fuel between seasons, using old fuel can damage heater.

- 5.1.5. Store Heater in a dry, well ventilated area. Be sure that the storage area is free of dust and corrosive vapours. Repack the heater in the original packaging and keep user's manual in an easily accessible place.

### 5.2. FUEL / FUEL TANK

- 5.2.1. Flush tank every 200 hours of operation or as needed. **DO NOT** flush with water, use fresh paraffin (to flush NOT to fuel) only.
  - ✓ Only suitable for clean, fresh, filtered diesel.
  - ✗ **DO NOT** use "old" or "second-hand" diesel or anything other than clean, fresh, new diesel.
  - ✗ **DO NOT** use low-quality diesel. Always use high-quality and clean fuel that has been filtered before use. Using any other type of fuel will invalidate the warranty and could cause an explosion, a fire or the unit to malfunction.

### 5.3. NOZZLES

- 5.3.1. Nozzles should be cleaned or replaced at least once per heating season. Contaminated fuel could make this necessary immediately.
- 5.3.2. To clean dirt from nozzle, blow compressed air through nozzle front. it may be necessary to soak nozzle in clean paraffin or diesel to help loosen any particles.

### 5.4. FLAME SENSOR (fig.2)

- 5.4.1. The photocell should be cleaned at least once per heating season or more depending on conditions, use a cotton swab and water or alcohol to clean the lens of the photocell. Ensure the sensor is fully engaged when replacing it (fig.2)

### 5.5. FILTERS

- 5.5.1. The fuel filter and oil filter should be cleaned at least twice per heating season by rinsing it in clean paraffin or diesel. Contaminated or old fuel could make cleaning necessary immediately.

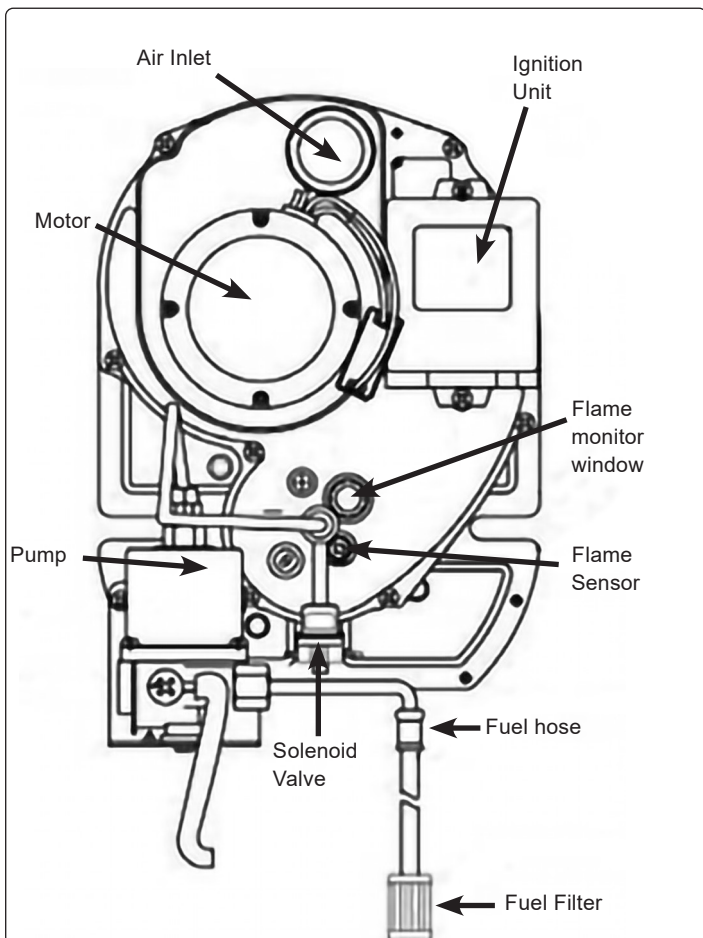
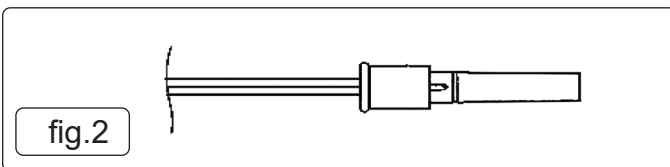

## 6. TROUBLESHOOTING

Error Code	Cause	Solution.
Er01	Temperature sensor open or error.	Retighten connections.
Er02	Tipping over beyond 15°	Disconnect power supply and adjust levels.
Er04	Fire sensor connection.	Retighten connections.
Er05 and Misfire light	Air in fuel line.	Restart.
	No fuel.	Check fuel levels. Fill with clean, fresh, filtered diesel as per instructions.
	Filter clogged.	Clean / change filter.
	Motor failure.	Return to Supplier for Service.
	Ignitor failing.	
Pump failure.		
Er06	Temperature overheating.	Check unit is not covered.
Er09	Oil level sensor fault.	Retighten connections.
Overheating	Set temperature is below ambient.	Adjust temperature setting.



### ENVIRONMENT PROTECTION

Recycle unwanted materials instead of disposing of them as waste. All tools, accessories and packaging should be sorted, taken to a recycling centre and disposed of in a manner which is compatible with the environment. When the product becomes completely unserviceable and requires disposal, drain any fluids (if applicable) into approved containers and dispose of the product and fluids according to local regulations.



REGISTER YOUR PURCHASE HERE



### WEEE REGULATIONS

Dispose of this product at the end of its working life in compliance with the EU Directive on Waste Electrical and Electronic Equipment (WEEE). When the product is no longer required, it must be disposed of in an environmentally protective way. Contact your local solid waste authority for recycling information.

**NOTE:** It is our policy to continually improve products and as such we reserve the right to alter data, specifications and component parts without prior notice. Please note that other versions of this product are available. If you require documentation for alternative versions, please email or call our technical team on [technical@sealey.co.uk](mailto:technical@sealey.co.uk) or 01284 757505.

**IMPORTANT:** No Liability is accepted for incorrect use of this product.

**WARRANTY:** Guarantee is 36 months from purchase date, proof of which is required for any claim.

Sealey Group, Kempson Way, Suffolk Business Park, Bury St Edmunds, Suffolk. IP32 7AR



01284 757500



[sales@sealey.co.uk](mailto:sales@sealey.co.uk)



[www.sealey.co.uk](http://www.sealey.co.uk)



## Information requirements for gaseous/liquid fuel local space heaters

Model identifier(s): IR13.V2										
Indirect heating functionality:    Yes                      No <input checked="" type="checkbox"/>										
Direct heat output:    13            (kW)				Indirect heat output:    N/A            (kW)						
<b>Fuel</b>						Space heating emissions NO <sub>x</sub> nitrogen oxides				
Select fuel type:	Gaseous	Liquid <input checked="" type="checkbox"/>	Specify: Diesel			127.37 [mg/kWh <sub>input</sub> ] (GCV)				
Item	Symbol	Value	Unit	Item	Symbol	Value	Unit			
<b>Heat output</b>				<b>Useful efficiency (NCV)</b>						
Nominal heat output	$P_{nom}$	13	kW	Useful efficiency at nominal heat output	$\eta_{th,nom}$	91.4	%			
Minimum heat output (indicative)*	$P_{min}$	N/A	kW	Useful efficiency at minimum heat output (indicative)*	$\eta_{th,min}$	N/A	%			
<b>Auxiliary electricity consumption</b>				<b>Type of heat output/room temperature control (select one)</b>						
At nominal heat output	$eI_{max}$	0.08	kW	Single stage heat output, no room temperature control	Yes	No <input checked="" type="checkbox"/>				
At minimum heat output	$eI_{min}$	0	kW	Two or more manual stages, no room temperature control	Yes	No <input checked="" type="checkbox"/>				
In standby mode	$eI_{SB}$	0.0016	kW	With mechanical thermostat room temperature control	Yes	No <input checked="" type="checkbox"/>				
* Enter figure or NA				With electronic room temperature control	Yes	No <input checked="" type="checkbox"/>				
				With electronic room temperature control plus day timer	Yes <input checked="" type="checkbox"/>	No				
				With electronic room temperature control plus week timer	Yes	No <input checked="" type="checkbox"/>				
				<b>Other control options (multiple selections possible)</b>						
				Room temperature control, with presence detection	Yes	No <input checked="" type="checkbox"/>				
				Room temperature control, with open window detection	Yes	No <input checked="" type="checkbox"/>				
				With distance control option	Yes	No <input checked="" type="checkbox"/>				
				With adaptive start control	Yes	No <input checked="" type="checkbox"/>				
<b>Permanent pilot flame power requirement</b>				With working time limitation	Yes	No <input checked="" type="checkbox"/>				
Pilot flame power required (if applicable)*	$P_{pilot}$	N/A	kW	With black bulb sensor	Yes	No <input checked="" type="checkbox"/>				
<b>The seasonal space heating energy efficiency <math>\eta_s</math></b>										
Item	Symbol	Value	Unit							
The seasonal space heating Energy efficiency in active mode	$\eta_{s,on}$	100.0	%							
The seasonal space heating energy efficiency $\eta_s$	$\eta_s$	91.4	%							
<b>Energy efficiency classes</b>				A						
Contact details: Sealey Group, Kempson Way, Suffolk Business Park, Bury St Edmunds, Suffolk, IP32 7AR.    www.sealey.co.uk										
v1				ERP Table 1						



## Information requirements for gaseous/liquid fuel local space heaters

Model identifier(s): IR16.V2										
Indirect heating functionality:    Yes                      No <input checked="" type="checkbox"/>										
Direct heat output:    16            (kW)				Indirect heat output:    N/A            (kW)						
<b>Fuel</b>						Space heating emissions NO <sub>x</sub> nitrogen oxides				
Select fuel type:	Gaseous	Liquid <input checked="" type="checkbox"/>	Specify: Diesel			122.30 [mg/kWh <sub>input</sub> ] (GCV)				
Item	Symbol	Value	Unit	Item	Symbol	Value	Unit			
<b>Heat output</b>				<b>Useful efficiency (NCV)</b>						
Nominal heat output	$P_{nom}$	16	kW	Useful efficiency at nominal heat output	$\eta_{th,nom}$	91.7	%			
Minimum heat output (indicative)*	$P_{min}$	N/A	kW	Useful efficiency at minimum heat output (indicative)*	$\eta_{th,min}$	N/A	%			
<b>Auxiliary electricity consumption</b>				<b>Type of heat output/room temperature control (select one)</b>						
At nominal heat output	$eI_{max}$	0.08	kW	Single stage heat output, no room temperature control	Yes	No <input checked="" type="checkbox"/>				
At minimum heat output	$eI_{min}$	0	kW	Two or more manual stages, no room temperature control	Yes	No <input checked="" type="checkbox"/>				
In standby mode	$eI_{SB}$	0.0016	kW	With mechanical thermostat room temperature control	Yes	No <input checked="" type="checkbox"/>				
* Enter figure or NA				With electronic room temperature control	Yes	No <input checked="" type="checkbox"/>				
				With electronic room temperature control plus day timer	Yes <input checked="" type="checkbox"/>	No				
				With electronic room temperature control plus week timer	Yes	No <input checked="" type="checkbox"/>				
				<b>Other control options (multiple selections possible)</b>						
				Room temperature control, with presence detection	Yes	No <input checked="" type="checkbox"/>				
				Room temperature control, with open window detection	Yes	No <input checked="" type="checkbox"/>				
				With distance control option	Yes	No <input checked="" type="checkbox"/>				
				With adaptive start control	Yes	No <input checked="" type="checkbox"/>				
<b>Permanent pilot flame power requirement</b>				With working time limitation	Yes	No <input checked="" type="checkbox"/>				
Pilot flame power required (if applicable)*	$P_{pilot}$	0	kW	With black bulb sensor	Yes	No <input checked="" type="checkbox"/>				
<b>The seasonal space heating energy efficiency <math>\eta_s</math></b>										
Item	Symbol	Value	Unit							
The seasonal space heating Energy efficiency in active mode	$\eta_{s,on}$	100	%							
The seasonal space heating energy efficiency $\eta_s$	$\eta_s$	91.7	%							
<b>Energy efficiency classes</b>				A						
Contact details: Sealey Group, Kempson Way, Suffolk Business Park, Bury St Edmunds, Suffolk, IP32 7AR.    www.sealey.co.uk										
v1				ERP Table 1						