



INSTRUCTIONS FOR HVLP SPRAY GUN KIT 600W 230V MODEL NO: HVLP2000.V2

Thank you for purchasing a Sealey product. Manufactured to a high standard, this product will, if used according to these instructions, and properly maintained, give you years of trouble free performance.

IMPORTANT: PLEASE READ THESE INSTRUCTIONS CAREFULLY. NOTE THE SAFE OPERATIONAL REQUIREMENTS, WARNINGS & CAUTIONS. USE THE PRODUCT CORRECTLY AND WITH CARE FOR THE PURPOSE FOR WHICH IT IS INTENDED. FAILURE TO DO SO MAY CAUSE DAMAGE AND/OR PERSONAL INJURY AND WILL INVALIDATE THE WARRANTY. KEEP THESE INSTRUCTIONS SAFE FOR FUTURE USE.



Refer to
Instruction
Manual



Wear eye
Protection



Wear
Respiratory
Protection

1. SAFETY

1.1. Electrical Safety

- ❑ **WARNING!** It is the user's responsibility to check the following:

- 1.1.1. Check all electrical equipment and appliances to ensure that they are safe before using. Inspect power supply leads, plugs and all electrical connections for wear and damage. Sealey recommend that an RCD (Residual Current Device) is used with all electrical products. You may obtain an RCD by contacting your local Sealey dealer.
- 1.1.2. If the spray gun is used in the course of business duties, it must be maintained in a safe condition and routinely PAT (Portable Appliance Test) tested.

Electrical safety information, it is important that the following information is read and understood.

- 1.1.3. Ensure that the insulation on all cables and on the appliance is safe before connecting it to the power supply.
- 1.1.4. Regularly inspect power supply cables and plugs for wear or damage and check all connections to ensure that they are secure.
- 1.1.5. **Important:** Ensure that the voltage rating on the appliance suits the power supply to be used and that the plug is fitted with the correct fuse - see fuse rating in these instructions.
 - × **DO NOT** pull or carry the appliance by the power cable.
 - × **DO NOT** pull the plug from the socket by the cable. Remove the plug from the socket by maintaining a firm grip on the plug.
 - × **DO NOT** use worn or damaged cables, plugs or connectors. Ensure that any faulty item is repaired or replaced immediately by a qualified electrician.
- 1.1.6. This product is fitted with a BS1363/A 13 Amp 3 pin plug.
If the cable or plug is damaged during use, switch the electricity supply and remove from use.
Replace a damaged plug with a BS1363/A 13 Amp 3 pin plug. If in doubt contact a qualified electrician.

Class II products are wired with live (brown) and neutral (blue) only are marked with the Class II symbol;

A) Connect the BROWN live wire to the live terminal 'L'.

B) Connect the BLUE neutral wire to the neutral terminal 'N'.

C) After wiring, check that there are no bare wires and ensure that all wires have been correctly connected.

Ensure that the cable outer sheath extends inside the cable restraint and that the restraint is tight.

- × **DO NOT** connect either wire to the earth terminal.
Sealey recommend that repairs are carried out by a qualified electrician.

1.2. General Safety

Familiarise yourself with the application, limitations and potential hazards peculiar to the spray gun.

- ❑ **WARNING!** Disconnect the spray gun from the air hose before changing accessories, servicing or performing any maintenance.
- ✓ Maintain the spray gun in good condition (use an authorised service agent).
- ✓ Replace or repair damaged parts. *Use recommended parts only. Unauthorised parts may be dangerous and will invalidate the warranty.*
- ✓ Keep the spray gun clean for best and safest performance.
- ✓ Wear approved safety respiratory protection and safety goggles.
- ✓ Remove ill fitting clothing. Remove ties, watches, rings, and other loose jewellery, and tie back long hair.
- ✓ Locate the spray gun in the desired working area, keep area clean and tidy and free from unrelated materials and ensure that there is adequate ventilation and lighting.
- ✓ Keep children and unauthorised persons away from the working area.
- ✓ Avoid unintentional operation.
- × **DO NOT** point spray gun at yourself, other persons or animals.
- × **DO NOT** carry the spray gun by the hose, or yank the hose from the air outlet.
- × **DO NOT** use the spray gun for any purpose other than for which it is designed.
- × **DO NOT** allow untrained persons to operate the spray gun.
- × **DO NOT** get the spray gun wet and **DO NOT** use outside or in damp or wet locations or areas where there is condensation.
- × **DO NOT** operate the spray gun if any parts are missing or damaged as this may cause failure and/or possible personal injury.
- × **DO NOT** direct air from the air hose at yourself, other persons or animals..
- ✓ When not in use switch the unit off and disconnect from the mains power supply.

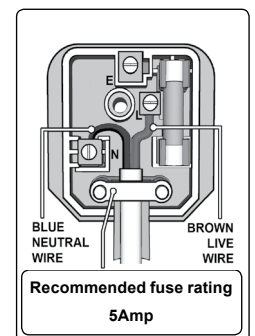

- ✗ **DO NOT** use the machine in the presence of flammable liquids or gases, or on premises where explosive substances are stored.
- ✗ **DO NOT** open the main unit or loosen or remove any of its retaining screws.
- ✗ **DO NOT** wipe plastic parts with any solvents such as petrol, thinners, carbon tetrachloride, alcohol or ammonia.
- ✗ **DO NOT** mix or thin paint in an area where there may be functioning appliances producing a naked flame or electrical sparking. This includes equipment that is electric motor powered.
- ✗ **DO NOT** switch on the spray gun when paint is being mixed or thinned.
- ✓ Ensure that any vapours have dispersed before switching on the spray gun.
- ✓ Tightly recap all containers immediately after thinning or mixing paint, and store away from the spraying area.
- ✗ **DO NOT** spray near any sources of ignition such as an open fire, cigarettes, cigars or pipes, sparks, glowing wires or hot surfaces or naked lighting.
- ✓ Ensure that the air hose is firmly connected to the unit and the gun to avoid the possibility of any spilt material being drawn into the unit.
- ✓ When not in use, thoroughly clean the spray gun and then store it in a safe, dry, childproof location.

2. INTRODUCTION

Utilises 600Watt electric motor with high performance turbine to deliver continuous volumes of air. Spray gun uses composite body, which has low affinity for paint, enabling quick and easy cleaning. Gun includes air and paint controls for fine adjustment of spray pattern. Suitable for interior and exterior use, applying water and oil based paints, lacquers and stains. Supplied with air hose, viscosity cup and shoulder strap.

3. SPECIFICATION

Model no:..... **HVLP2000.V2**
 Spray Gun Set-Up:2mm
 Pot Capacity:700ml
 Voltage:.....230V
 Power Consumption:600W
 Air Hose Length:..... 2.4m
 Weight:2.7kg

4. PAINT PREPARATION

4.1. Checking paint viscosity.

As most paints are made for brush or roller, it will normally be necessary to thin the paint to achieve proper atomisation and good coverage. Use the viscosity cup provided to check the viscosity of the material prior to thinning. Dip the cup into the paint to completely fill it and then time how long it takes for the paint to flow out again (fig.1). If the paint is the correct viscosity, the flow time should be approximately between 8 and 20 seconds. If the flow time is more than 20 seconds the paint is probably too thick. Thin the paint slightly and retest until the flow time is within the limits stated. If the flow time is less than eight seconds the paint is too thin.

4.2. Paint condition.

Any debris in the paint will clog the spray gun, which will then require a complete strip down and clean, before the spray gun will function again properly. This is particularly important when using paint that has previously been opened. The paint should be thoroughly mixed and free from any lumps. If necessary, strain the paint through a 60 mesh paint strainer, to ensure a smooth finish. The paint should be strained into a clean container and if any paint is left over, it should be stored in a clean container.

5. ASSEMBLY / PREPARATION

- 5.1. Remove the spray gun from the unit and adjust the air cap by rotating it (or move the spray jets) to give the required spray pattern as shown in fig.2.
- 5.2. Unscrew the paint container. Fill container with paint (see Section 4 regarding paint preparation). Refit the paint container to the gun and tighten. Lay out the air hose and connect one end to the back of the unit using a push and twist action. Similarly connect the other end of the hose to the spray gun.
- 5.3. Plug the unit into the mains supply and switch it on. The unit is now ready to use.

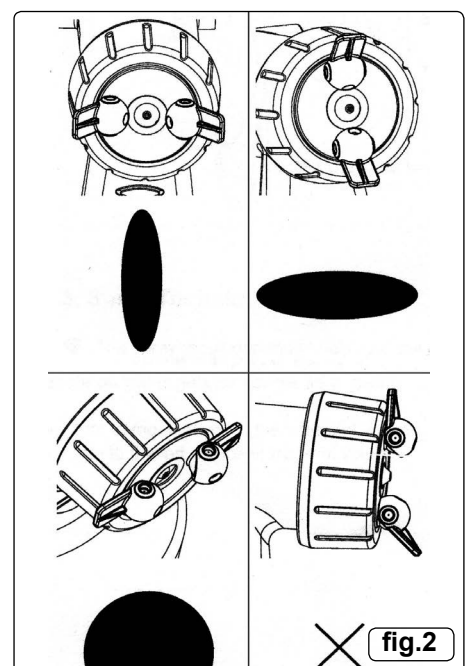
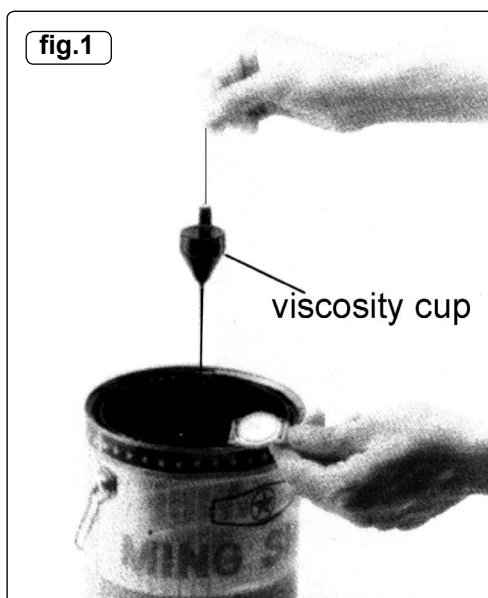

6. OPERATION

- 6.1. **The gun must be cleaned immediately after finishing using it.** On no account must any paint be allowed to even partially dry as this may make the gun unusable. Switch off the unit and disconnect from the mains supply before performing any maintenance or cleaning.
- 6.2. Empty the paint container immediately and flush it out. If using a water based paint, refill with clean water and operate the gun until it is spraying clean water only. If using an oil based paint, stain, or lacquer, clean the paint container with the appropriate thinning medium, then refill the container with the medium and operate the gun until all residue has been flushed out.
- 6.3. Clean the outside of the gun and the main unit with a soft cloth soaked in warm soapy water.
- 6.3.1. To maintain the spray gun in peak operational condition, the main parts should be regularly inspected and cleaned. Plastic parts can only be immersed in hot soapy water and brushed clean. Never soak plastic parts in any solvents as this may cause the parts to disintegrate.
- 6.4. Unscrew the nozzle retainer and remove the nozzle behind it (fig.4).
- 6.5. The fluid tube is a push fit into the main body of the gun. To remove for cleaning, simply pull it out of its seating.
- 6.6. Clean parts as previously directed and then carefully reassemble the gun in reverse order. When reassembling after cleaning / maintenance, be sure to take care when screwing parts together. **DO NOT** use excessive force when reassembling.
- 6.7. Should any deterioration in the performance of the spray gun occur, refer first to the trouble shooting guide, or return it to a Sealey service agent.
- 6.8. The air filter should be cleaned on a regular basis. Remove the filter cover by sliding it away from the unit and remove the foam filter.
- 6.9. If using water based paints clean the filter in mild soapy water and remove excess water by pressing in a soft cloth. Allow to dry before reinstalling. Slide the filter cover back into position.
- 6.10. Where a build-up of non-water soluble paint has occurred, the filter cannot be cleaned and will have to be replaced. To prolong filter life, place the main unit as far away as possible from the spraying area.

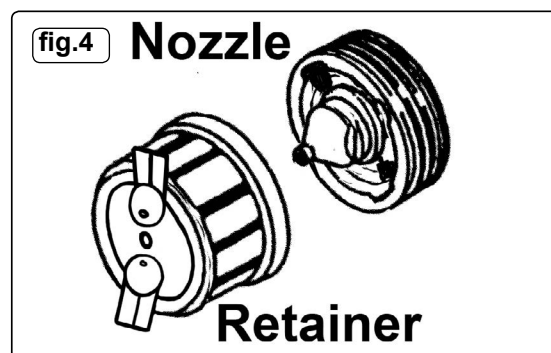
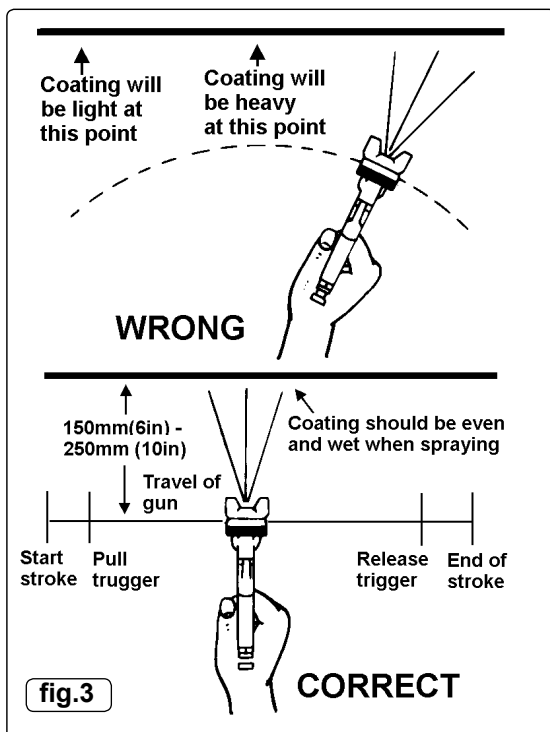







7. CLEANING

- 7.1. **The gun must be cleaned immediately after finishing using it.** On no account must any paint be allowed to even partially dry as this may make the gun unusable. Switch off the unit and disconnect from the mains supply before performing any maintenance or cleaning.
- 7.2. Empty the paint container immediately and flush it out. If using a water based paint, refill with clean water and operate the gun until it is spraying clean water only. If using an oil based paint, stain, or lacquer, clean the paint container with the appropriate thinning medium, then refill the container with the medium and operate the gun until all residue has been flushed out.
- 7.3. Clean the outside of the gun and the main unit with a soft cloth soaked in warm soapy water.
- 7.4. To maintain the spray gun in peak operational condition, the main parts should be regularly inspected and cleaned. Plastic parts can only be immersed in hot soapy water and brushed clean. Never soak plastic parts in any solvents as this may cause the parts to disintegrate.
- 7.5. Unscrew the nozzle retainer and remove the nozzle behind it (fig.4).
- 7.6. The fluid tube is a push fit into the main body of the gun. To remove for cleaning, simply pull it out of its seating.
- 7.7. Clean parts as previously directed and then carefully reassemble the gun in reverse order. When reassembling after cleaning / maintenance, be sure to take care when screwing parts together. **DO NOT** use excessive force when reassembling.
- 7.8. Should any deterioration in the performance of the spray gun occur, refer first to the trouble shooting guide, or return it to a Sealey service agent.
- 7.9. The air filter should be cleaned on a regular basis. Remove the filter cover by sliding it away from the unit and remove the foam filter.
- 7.10. If using water based paints clean the filter in mild soapy water and remove excess water by pressing in a soft cloth. Allow to dry before reinstalling. Slide the filter cover back into position.

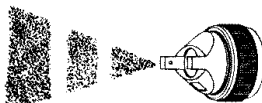
7.11. Where a build-up of non-water soluble paint has occurred, the filter cannot be cleaned and will have to be replaced. To prolong filter life, place the main unit as far away as possible from the spraying area.

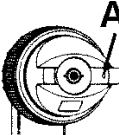
8. TROUBLESHOOTING

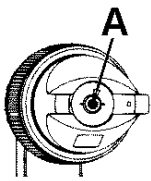
Problem	Cause	Solution
Poor atomisation, heavy centre pattern. 	Fluid flow is too high for the air flow.	1. Reduce fluid flow using the fluid control knob. 2. Fluid could be too thick, dilute.
Heavy atomisation, poor centre pattern. 	Fluid is too thin.	1. Increase proportion of fluid to thinning medium.
Intermittant spray pattern. 	Air entering the fluid supply.	1. Tighten the connection between the cup and the gun. 2. Check if paint pot is empty.
Heavy right or left side pattern.  	One of the horn holes blocked (A).	1. Place the nozzle in cleaning solution. 2. Clean hole with compressed air or with a soft probe. DO NOT use a metal probe which will damage the hole.
Top heavy or bottom heavy pattern.  	Possible fluid build up between fluid nozzle and needle.	1. Clean the fluid nozzle, check also that they match correctly. 2. Check needle for damage.



Environmental Protection

Recycle unwanted materials instead of disposing of them as waste. All tools, accessories and packaging should be sorted, taken to a recycling centre and disposed of in a manner which is compatible with the environment.



WEEE Regulations

Dispose of this product at the end of its working life in compliance with the EU Directive on Waste Electrical and Electronic Equipment (WEEE). When the product is no longer required, it must be disposed of in an environmentally protective way. Contact your local solid waste authority for recycling information.

NOTE: It is our policy to continually improve products and as such we reserve the right to alter data, specifications and component parts without prior notice.

IMPORTANT: No liability is accepted for incorrect use of this product.

WARRANTY: Guarantee is 12 months from purchase date, proof of which will be required for any claim.



Sole UK Distributor, Sealey Group.
 Kempson Way, Suffolk Business Park,
 Bury St. Edmunds, Suffolk.
 IP32 7AR



01284 757500



01284 703534



www.sealey.co.uk



sales@sealey.co.uk