



RADIAL PILLAR DRILLS

MODEL NO: **GDM790BR , GDM1630FR**

Thank you for purchasing a Sealey product. Manufactured to a high standard, this product will, if used according to these instructions, and properly maintained, give you years of trouble free performance.

IMPORTANT: PLEASE READ THESE INSTRUCTIONS CAREFULLY. NOTE THE SAFE OPERATIONAL REQUIREMENTS, WARNINGS & CAUTIONS. USE THE PRODUCT CORRECTLY AND WITH CARE FOR THE PURPOSE FOR WHICH IT IS INTENDED. FAILURE TO DO SO MAY CAUSE DAMAGE AND/OR PERSONAL INJURY AND WILL INVALIDATE THE WARRANTY. KEEP THESE INSTRUCTIONS SAFE FOR FUTURE USE.



Refer to instructions



Wear eye protection



Wear safety footwear



Wear ear protection



Wear a mask



Indoor use only

1. SAFETY

1.1. ELECTRICAL SAFETY

- ❑ **WARNING!** It is the user's responsibility to check the following:

Check all electrical equipment and appliances to ensure that they are safe before using. Inspect power supply leads, plugs and all electrical connections for wear and damage. Sealey recommend that an RCD (Residual Current Device) is used with all electrical products. You may obtain an RCD by contacting your local Sealey dealer. If the product is used in the course of business duties, it must be maintained in a safe condition and routinely PAT (Portable Appliance Test) tested.

Ensure that the insulation on all cables and on the appliance is safe before connecting it to the power supply.

- 1.1.1. Regularly inspect power supply cables and plugs for wear or damage and check all connections to ensure that they are secure.

- 1.1.2. **Important:** Ensure that the voltage rating on the appliance suits the power supply to be used and that the plug is fitted with the correct fuse - see fuse rating in these instructions.

- ✗ **DO NOT** pull or carry the appliance by the power cable.
- ✗ **DO NOT** pull the plug from the socket by the cable.
- ✗ **DO NOT** use worn or damaged cables, plugs or connectors. Ensure that any faulty item is repaired or replaced immediately by a qualified electrician.

- 1.1.3. This product is fitted with a BS1363/A 13 Amp 3 pin plug.

If the cable or plug is damaged during use, switch the electricity supply and remove from use.

Ensure that repairs are carried out by a qualified electrician.

Replace a damaged plug with a BS1363/A 13 Amp 3 pin plug. If in doubt contact a qualified electrician.

A) Connect the GREEN/YELLOW earth wire to the earth terminal 'E'.

B) Connect the BROWN live wire to the live terminal 'L'.

C) Connect the BLUE neutral wire to the neutral terminal 'N'.

Ensure that the cable outer sheath extends inside the cable restraint and that the restraint is tight.

Sealey recommend that repairs are carried out by a qualified electrician.

1.2. GENERAL SAFETY

- ❑ **WARNING!** Disconnect drill from mains power before changing accessories, servicing or performing any maintenance.
- ✓ Maintain the drill in good condition (use an authorised service agent).
- ❑ **WARNING! Keep all guards and holding screws in place, tight and in good working order. Check regularly for damaged parts. A guard or any other part that is damaged must be repaired or replaced before the tool is next used, to ensure that it will operate properly and perform its intended function. The safety guard is a mandatory fitting where drill is used in premises covered by the Health & Safety at Work Act.**
- ✓ Check alignment of moving parts and check for possible broken parts.
- ✓ Replace or repair damaged parts. *Use genuine Sealey parts only. Non-authorized parts may be dangerous and will invalidate the warranty.*
- ✓ Ensure the set screws of the head frame are screwed tight before using the drill.
- ✓ Secure the drill to the bench/floor to avoid the machine tipping, sliding or walking. Drill is designed for use with drill bits only. No other accessory may be used.
- ✓ Ensure the chuck is securely fastened to the spindle.
- ✓ Remove adjusting keys and wrenches from the machine and working area before switching on.
- ✓ Use clamps or a vice (not included) to secure the workpiece. Available from your Sealey stockist. **DO NOT** secure the workpiece by hand.
- ✓ Refer to speed chart for recommended drilling speeds.
- ❑ **WARNING!** Always wear approved eye or face protection when operating this drill. Use a dust mask if dust is generated.
- ❑ **WARNING! DO NOT** wear gloves when drilling.
- ✓ Others in the workplace should be kept at a safe distance from the drill, especially when it is in operation.
- ✓ Keep the work area as childproof as possible by using padlocks and master switches.
- ✓ Keep drill bits clean and sharp for best and safest performance.
- ✓ Remove ill fitting clothing. Remove ties, watches, rings and other loose jewellery and contain long hair.
- ✓ Locate the drill in a suitable work area, keep area clean and tidy and free from unrelated materials. Ensure there is adequate lighting.
- ✓ Maintain correct balance and footing. Ensure the floor is not slippery and wear non-slip shoes.

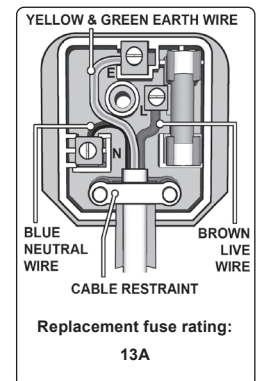

- ✓ Avoid unintentional starting.
- ✗ **DO NOT** use drill for a task it is not designed to perform.
- ✗ **DO NOT** allow untrained persons to operate the drill.
- ✗ **DO NOT** get the drill wet or use in damp or wet locations or areas where there is condensation.
- ✗ **DO NOT** operate the drill if damaged.
- ✗ **DO NOT** use drill in an area where paint fumes, solvents or flammable liquids pose a potential hazard. Keep flammable material away from the drill when operating. Flammable waste, such as wipes or cleaning rags, must be placed in a closed metal container and disposed of correctly.
- ✗ **DO NOT** exceed the rated capacity of the drill.
- ✗ **DO NOT** operate the drill if any parts are missing as this may cause failure and/or personal injury.
- ✗ **DO NOT** leave the drill operating unattended.
- ✗ **DO NOT** operate the drill when you are tired, under the influence of alcohol, drugs or intoxicating medication.
- ✓ When not in use switch off the drill, remove plug from the power supply and **DO NOT** leave until the tool has come to a complete stop.

2. INTRODUCTION

Heavy-duty construction. Safety devices fitted include a no-volt release switch and pulley cover cut-out microswitch. Radial feature allows off-table drilling and angle drilling. Features a maximum throat depth of 420mm. Radial arm controlled by rack and pinion assembly allowing fine positioning of drill bit. Mortise attachment available, order Model No. MA10. Also available as floor standing type - Model No. GDM1630FR.

3. SPECIFICATION

Model No:	GDM790BR	GDM1630FR
Drilling Capacity (Chuck Size):	16mm	16mm
Spindle Nose Taper:	MT2	MT2
Maximum Distance Spindle to Base:	470mm	1280mm
Maximum Distance Spindle to Table	300mm	830mm
Radial Arm Travel:	285mm	285mm
Spindle Travel:	80mm	80mm
Number of Speeds:	5	5
Speed Range:	500-2450rpm	500-2450rpm
Working Table Surface Size:	Ø310mm	Ø310mm
Working Base Surface Size:	160 x 180mm	210 x 190mm
Overall Base Size:	345 x 215mm	420 x 250mm
Column Diameter:	60mm	70mm
Collar Diameter:	60mm	60mm
Overall Height:	820mm	1630mm
Motor Power (Start):	350W (550W)	550W
Supply:	230V	230V
Optional Keyless Chuck 16mm:	GDMX/KC	GDMX/KC

4. CONTENTS

If any items are damaged or missing contact your supplier.

Head Assembly	Column with Flange	Rack & Rack Ring
Base	Cable	Table Arm, Bracket and Worm Gear
Adjusting Handle (table)	Feed Handles and Knobs (3)	Pivoted Clamp Bolts (4 - GDM790BR, 5 - GDM1630FR)
Chuck and Key	Safety Guard	Bolts (4)
Hex. Keys (2) & Wedge	Belt	Locking Shoe
Coach Bolts and Wing Nuts		

5. ASSEMBLY

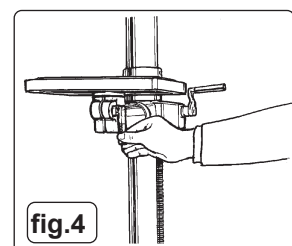
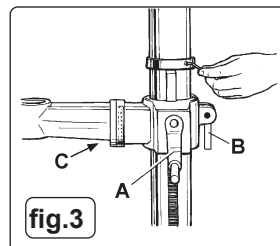
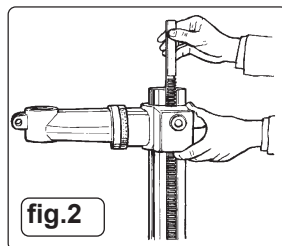
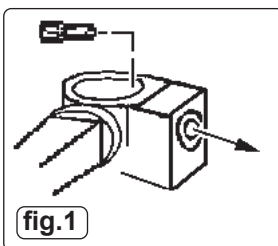

- Notes:** 1) Diagrams are illustrative and may differ in detail from your drill.
 2) Numbers in brackets refer to item numbers in the Parts List and Diagram

5.1. ASSEMBLY

- 5.1.1. Place the column (4) on the base (2), align holes and secure with the bolts (5) provided.
- 5.1.2. Insert worm gear (9) into table bracket, meshing it with the lift gear (7) (fig.1).
- 5.1.3. Fit table bracket (6) onto column (4) together with rack (15) (fig.2), engaging gear (7) in bracket with rack.
- 5.1.4. Install the rack collar (93) and tighten set screw (94) firmly (fig.3).
- 5.1.5. Fit the table adjusting handle (10) (fig.3.A) and lock handle (14) (fig.3.B).
- 5.1.6. Tighten the adjusting handle set screw (11) onto the flat on the worm gear shaft (9).
- 5.1.7. Install the table (16) and table lock handle (14) (fig.4).
- 5.1.8. Ensure that the column head assembly (83) is approximately midway between the motor (69) and the spindle housing (25) and then insert locking shoe (88) into column head (84) (fig.5).
- 5.1.9. Place the head assembly over the column (4) and slide column head (84) down onto column. Tighten lock handles (fig.6).
 - **WARNING!** If the column head assembly is not positioned midway there is a risk that the whole drill assembly may become unstable when the head assembly is fitted.

- 5.1.10. Screw the three feed handles and knobs (37/38) into the hub (35) of the pinion shaft.
- 5.1.11. To install chuck (46) open the chuck jaws completely by turning the chuck key (46A) counter-clockwise. Hold chuck on spindle and tap into place on taper with a hammer (fig.7).
- 5.1.12. Loosen clamp screw on safety guard mounting collar, pass guard up over chuck and fit collar round flange of quill (40). Ensure guard pivot is central and tighten clamp screw (see fig.8).
- 5.1.13. Open pulley cover (48), loosen butterfly set screw (36) on motor adjustment and fit belt (73) to pulleys(19/79). Pull motor (69) back to tension belt and retighten screw (36).

5.2. DRILL MOUNTING

- ☐ **WARNING!** For stability and safety it is imperative that the drill base is securely bolted to the workbench (GDM790BR) or floor (GDM1630FR).
- 5.2.1. Ensure that the mounting surface is capable of supporting the drill together with the weight of the heaviest likely workpiece.

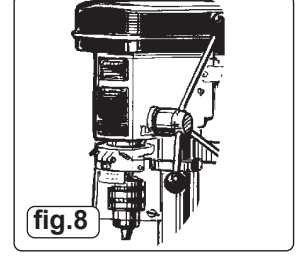
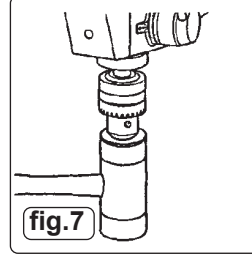
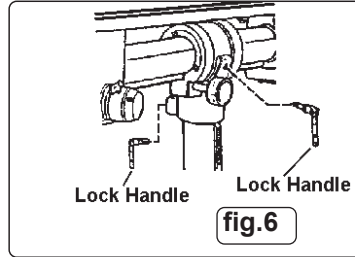
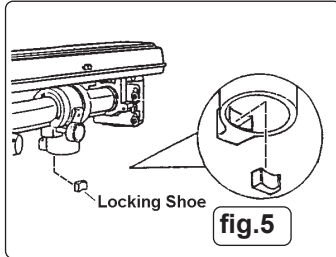

6. OPERATION

WARNING! Ensure the drill is unplugged from the mains power supply before commencing.

6.1. INSTALLING DRILL BIT

- 6.1.1. Insert drill bit into chuck jaws to 1" (25mm) deep (avoid inserting small bits too far) and centre bit in chuck before tightening.

6.2. ADJUSTING THE TABLE

- 6.2.1. To adjust table up or down, loosen lock handle (fig.3.B) then turn bracket handle (fig.3.A). Once at correct height tighten lock handle.
- 6.2.2. To adjust table tilt, loosen the work table bolt (fig.3.C), adjust table to the desired angle, then re-tighten bolt.
- 6.2.3. To turn the table around the column, loosen the rack collar slightly, then loosen the lock handle (fig.3.B).
- 6.2.4. Turn the table to the desired position then secure the lock handle and rack collar.

6.3. ADJUSTING THE SPEED

NOTE: the belt cover is fitted with a micro-switch to prevent drill operation with the cover open.

- 6.3.1. Open the pulley cover (48) and loosen the motor adjustment screw (36).
- 6.3.2. Choose the speed for the drilling operation (see drill speed chart - Section 7) and move the belt to the correct pulley grooves for that speed, as shown on the pulley chart - Section 7.

6.4. BELT TENSION

- 6.4.1. With the motor adjustment clamp screw (36) loose and using hand pressure on the motor, set tension so that belt give is no more than 10mm each side, at centre span, under finger pressure. Tighten clamp screw (36).

6.5. POSITIONING THE WORKPIECE

- 6.5.1. Rest the workpiece on a piece of wood to prevent the drill bit damaging the table when it breaks through the workpiece. The wood should rest on the table so that one end of it is against the left side of the column. This will prevent the wood spinning when the drill bit breaks through into it.
- 6.5.2. For small workpieces that cannot be clamped to the table, use a drill vice (not included). Vice must be bolted to table.

6.6. SETTING THE DRILL DEPTH

- 6.6.1. Use the scale on the side of the drill head near the drill handle.
- 6.6.2. Loosen locking screw (36) and set the scale to the depth required. Tighten locking screw.
- 6.6.3. When ready to drill, simply pull the feed handle. The drill will stop at the set depth.

6.7. SETTING THE DRILL HEAD

- 6.7.1. Fore and aft movement
 - 6.7.1.1. Loosen clamping lever (fig.9.A) and turn feed knob (fig.9.B) to move head to the required position. Re-tighten clamping lever.
 - 6.7.1.2. Horizontal rotation
 - 6.7.1.3. Loosen clamping lever (fig.10.A) and rotate head on column to required position (360° rotation is available). Re-tighten clamping lever.
 - 6.7.2. Tilting
 - 6.7.2.1. Loosen clamping lever (fig.9.A), Pull out and turn - to hold out - vertical lock (fig.10.B). Head may now be tilted up to 45° clockwise and 90° anticlockwise. Angular position is shown by line (fig.9.C) against scale (fig.9.D). When set, re-tighten clamping lever. After returning head to the vertical position always re-engage the vertical lock.
- 6.7.3. Head square to table
 - 6.7.3.1. Confirm that head is in the 'vertical' position, that the vertical lock (fig.10.B) is engaged and that the clamping lever (fig.9.A) is tight.
 - 6.7.3.2. Using a spirit level check that table is horizontal and, if necessary, adjust as in para.6.2.2.
 - 6.7.3.3. Clamp a straight rod, or a drill bit, in the chuck and use a machinist's square to check that the rod is perpendicular to the table. Adjust drill head as necessary by loosening the two set screws (fig.11.A) either side of the spindle housing and rotating the housing on the horizontal tube (81). When correctly positioned, re-tighten set screws.

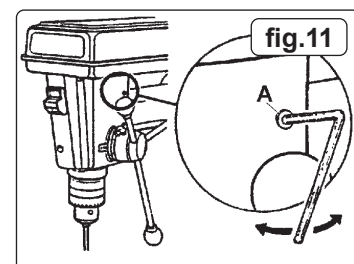
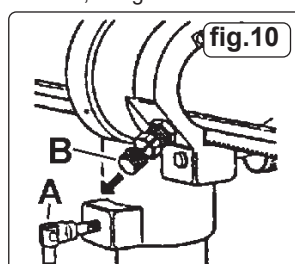
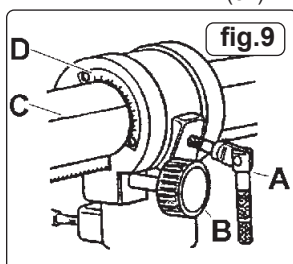

7. DRILL SPEEDS

The chart below shows recommended drill speeds for various bit diameters and materials. Select the available drill speed that is the same as, or nearest to, the one recommended for the task in hand.

Drill Diameter (mm)	Drill Speed (rpm)			
	Steel	Cast Iron	Iron	Alum' & Copper
3	1820	2580	2580	2580
4	1350	1820	1820	2580
5	1290	1350	1350	2580
6	970	1290	1290	2580
7	830	970	970	2580
8	830	970	970	2580
9	500	970	830	1820
10	500	830	830	1820
11	500	830	830	1820
12	420	830	500	1820
13	420	500	500	1350
14	420	500	500	1350
16	320	500	500	1290
18	320	420	420	1290
20	280	320	320	970
22	210	320	280	970
25	120	280	210	830

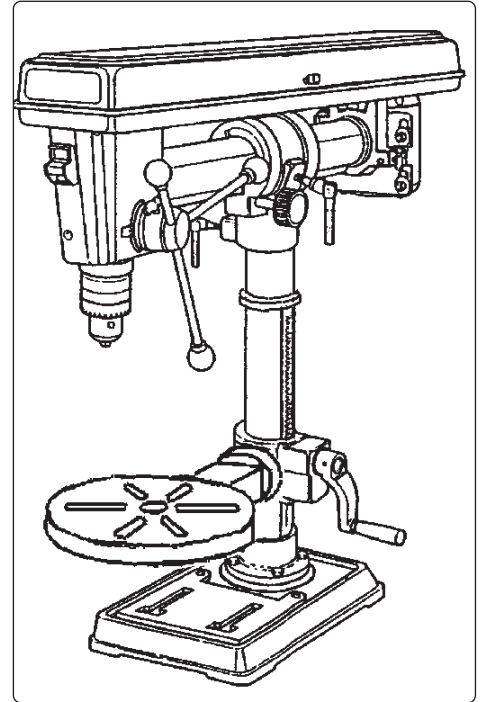

Drill Speed (rpm)

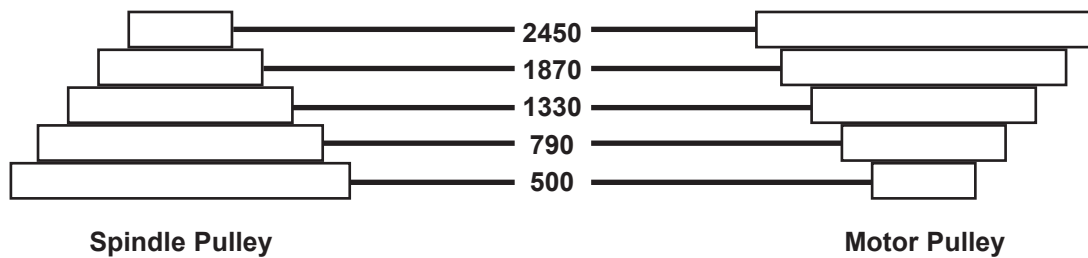

8. MAINTENANCE

- 8.1. Clean the drill after each use. A coat of automobile-type wax applied to the table and column will help to keep the surfaces clean.
- 8.2. Blow out any dust that may have accumulated in the motor.
- 8.3. Periodically lubricate the table elevation rack/gear/worm mechanism.
- 8.4. **BELT CHANGING** Please note that an instructional video for this product is available to view on our YouTube channel. [YouTube](#)
 - 8.4.1. Open the pulley cover (48) and loosen the motor adjustment screw (36).
 - 8.4.2. With the tension released, remove the belt and fit a replacement to the same specification as the original.
 - 8.4.3. With the motor adjustment clamp screw (36) loose and using hand pressure on the motor, set tension so that belt deflection is no more than 10mm each side, at centre span, under finger pressure. Tighten clamp screw (36).

9. TROUBLESHOOTING

PROBLEM	POSSIBLE CAUSE	SOLUTION
Machine will not start	1. Micro switch in belt cover not closed	1. Adjust striker plate
Excessive noise	1. Incorrect belt tension 2. Spindle is dry 3. Pulley is loose 4. Bearing damaged	1. Adjust tension 2. Disassemble spindle/quill and lubricate 3. Tighten pulley 4. Replace the bearing
Excessive drill wobble	1. Chuck is loose 2. Bearing or spindle shaft is worn 3. Chuck is worn 4. Drill fitted incorrectly or faulty	1. Refit the chuck (see 5.1.11) 2. Replace worn part 3. Replace the chuck 4. Fit correctly or change drill
Drill binds in the workpiece	1. Feed pressure is wrong 2. Belt is loose 3. Drill bit is loose 4. Speed is too fast	1. Apply less pressure 2. Adjust tension 3. Tighten the chuck jaws with the key 4. Change the speed
Drill burns or smokes	1. Speed is too fast 2. Chips are not discharging 3. Drill bit is blunt 4. Lubrication needed 5. Feed pressure is wrong	1. Change the speed 2. Clean the drill bit 3. Use a new bit 4. Lubricate while drilling 5. Apply less pressure
Table is difficult to raise/lower	1. Lubrication is needed 2. Rack is bent	1. Lubricate with light oil 2. Straighten the rack



ENVIRONMENT PROTECTION

Recycle unwanted materials instead of disposing of them as waste. All tools, accessories and packaging should be sorted, taken to a recycling centre and disposed of in a manner which is compatible with the environment. When the product becomes completely unserviceable and requires disposal, drain any fluids (if applicable) into approved containers and dispose of the product and fluids according to local regulations.



WEEE REGULATIONS

Dispose of this product at the end of its working life in compliance with the EU Directive on Waste Electrical and Electronic Equipment (WEEE). When the product is no longer required, it must be disposed of in an environmentally protective way. Contact your local solid waste authority for recycling information.

Note: It is our policy to continually improve products and as such we reserve the right to alter data, specifications and component parts without prior notice.

Important: No Liability is accepted for incorrect use of this product.

Warranty: Guarantee is 12 months from purchase date, proof of which is required for any claim.

Sealey Group, Kempson Way, Suffolk Business Park, Bury St Edmunds, Suffolk. IP32 7AR



01284 757500



01284 703534



sales@sealey.co.uk



www.sealey.co.uk