

baridi

40 Bottle/120 Can Under-Counter/Freestanding Dual Zone Wine Fridge & Cooler 60cm

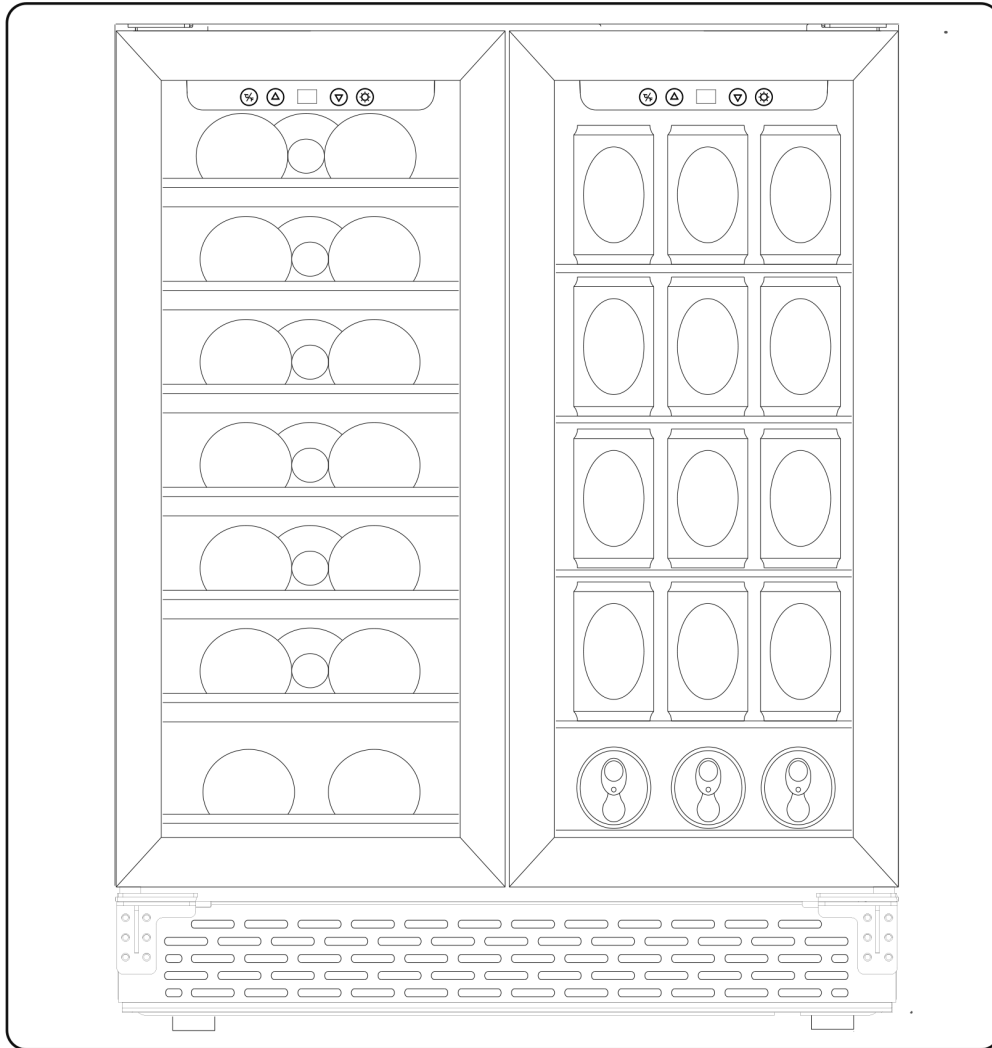

Model No. DH96.V2

Thank you for purchasing a Baridi product from the Dellonda range. Manufactured to a high standard, this product will, if used according to these instructions, and properly maintained, give you years of trouble free performance.

Important Information

Please read these instructions carefully. Note the safe operational requirements, warnings & cautions. Use the product correctly and with care for the purpose for which it is intended. Failure to do so may cause damage and/or personal injury and will invalidate the warranty. Keep these instructions safe for future use.



Refer to
instruction
manual



Indoor use
only



Warning:
flammable
material

• ELECTRICAL SAFETY

- **WARNING!** It is the user's responsibility to check the following:
- Check all electrical equipment and appliances to ensure that they are safe before using.
- Inspect power supply leads, plugs and all electrical connections for wear and damage.
- Ensure that the insulation on all cables and on the appliance is safe before connecting it to the power supply.
- **DO NOT** use worn or damaged cables, plugs or connectors.
- Ensure that any faulty item is repaired or is replaced immediately by a qualified electrician.
- If the cable or plug is damaged during use, switch off the electricity supply and remove from use.
- **Ensure that repairs are carried out by a qualified electrician.**
- Sealey recommend that an RCD (Residual Current Device) is used with all electrical products.
- **Important:** Ensure that the voltage rating on the appliance suits the power supply to be used and that the plug is fitted with the correct fuse
- Ensure to make provisions to allow to disconnect the cooler from the mains supply after installation.
- **DO NOT** pull or carry the appliance by the power cable.
- **DO NOT** lift unit by door handle.
- Keep the door closed before installing into cabinet.
- Allow unit temperature to stabilize for 24 hours before use.
- **DO NOT** block any internal fans.
- Be sure the kick-plate on the front bottom is free from obstruction. Obstructing free airflow can cause the unit to malfunction and will void the warranty.
- If the supply cord is damaged, it must be replaced by the manufacturer, its service agent or similarly qualified persons in order to avoid a hazard.
- Use only genuine parts and accessories. Unauthorised parts and accessories may be dangerous and will invalidate your warranty.
- Applicable spare parts are available for the life of the product and for 7-10 years after a product line is discontinued by Sealey.
- **WARNING!** When positioning the appliance, ensure the supply cord is not trapped or damaged.
- **WARNING! DO NOT** locate multiple portable socket-outlets or portable power supplies at the rear of the appliance.
- Children aged from 3 to 8 years are allowed to load and unload refrigerating appliances. Children from age 8 years and above, persons with reduced physical, sensory, or mental capabilities those with lack of experience and knowledge can use the appliance, if they have been given supervision or instruction concerning use of the appliance in a safe way to understand the hazards involved.
- Children shall NOT play with the appliance
- Cleaning and user maintenance on the appliance shall not be made by children without supervision.
- The appliance shall be disconnected from its power source during service and when replacing parts.

• GENERAL SAFETY

- **DO NOT** store explosive substances such as aerosol cans with a flammable propellant in this appliance.
- **WARNING!** Ensure the supply cord is not trapped or damaged.
- **WARNING! DO NOT** locate multiple portable socket-outlets or portable power supplies at the rear of the appliance.
- This appliance is intended to be used in household and similar applications such as staff kitchen areas in shops, offices and other working environments; holiday homes, hotels and other residential settings; and catering and similar non-retail applications.
- This appliance is intended to be used exclusively for the storage of wine.
- This refrigeration appliance is intended to be used at ambient temperature ranging from 16°C to 32°C.
- This appliance is intended to be used in household and similar applications such as
 - – staff kitchen areas in shops, offices and other working environments;
 - – farm houses and by clients in hotels, motels and other residential type environments;
 - – bed and breakfast type environments;
 - – catering and similar non-retail applications.
- **WARNING!** To avoid a hazard due to instability of the appliance, it must be fixed in accordance with the instructions.
- **WARNING!** When positioning the appliance, ensure the supply cord is not trapped or damaged.
- **WARNING! DO NOT** locate multiple portable socket-outlets or portable power supplies at the rear of the appliance.
- **WARNING!** Keep ventilation openings, in the appliance enclosure or in the built-in structure, clear of obstruction.
- **WARNING! DO NOT** use mechanical devices or other means to accelerate the defrosting process, other than those recommended by the manufacturer.
- **WARNING!** Risk of fire or explosion. Flammable refrigerant used. To be repaired or serviced only by trained personnel.
- **WARNING! DO NOT** damage the refrigerant circuit.
- **WARNING! DO NOT** use electrical appliances inside the food storage compartments of the appliance, unless they are of the type recommended by the manufacturer.

• **INTRODUCTION**

- Add style to your kitchen with this 60cm slim built dual zone-under wine cooler! Fits under standard height worktops and door at the perfect height to sit above standard height kick plates. Dual cooling zones with digital temperature control between 5-18°C allowing you to chill up to 40 bottles of wine to the perfect temperature. Stylish stainless steel door handle, wooden shelves and internal LED light. Super quiet compressor cooling with a noise level of just 41dB.

• **CONTENTS / SPECIFICATION**

1	Left light switch	16	Exhaust Window
2	Left temperature setting	17	Foot
3	Left temperature display	18	Kick Plate
4	Left temperature setting	19	Right Light Switch
5	Left upper hinge	20	Right Temperature Setting
6	°C/°F Switch	21	Right Temperature Display
7	Left Fan	22	Right Temperature Setting
8	Left Light	23	Right Upper Hinge
9	Exhaust Window	24	Right Fan
10	Left Handle	25	Right Light
11	Left Glass	26	Right Handle
12	Left Door Seal	27	Right Glass
13	NTC Point	28	Right Door Seal
14	Shelf		
15	Carbon Filter		

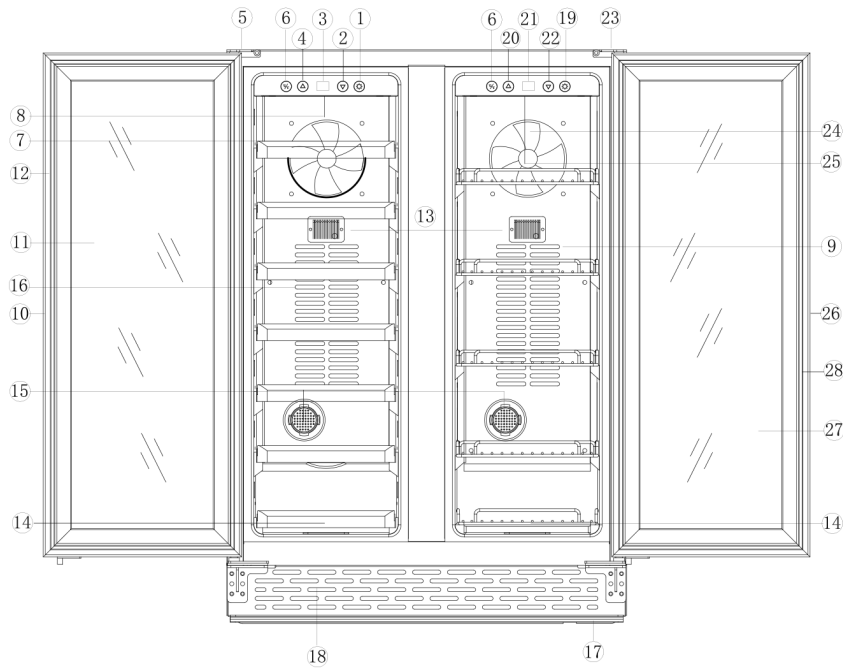



Model no	DH96.V2	Temperature Range	5 - 18°C
Capacity	40 Bottles	Voltage/Frequency	230V 50Hz
Colour of Product	Black	Volume	112L
Electrical Class	Class I		
Energy Rating	G		
Maximum Bottle Height	300mm		
Nett Weight	42.8kg		
Noise Level	41dB		
Plug Type	3-Pin BS		
Product Dimensions (W x D x H)	595 x 570 x 825mm		
Rated current	0.8A		

• Door Installation

- After 24 additional hours, fill with wine bottles. Allow beverage & wine cooler to adjust to reach your set temperature.
- To remove a wine bottle, gently pull shelf out a little, lift upper shelf slightly, and carefully remove bottles.

• To install the door handle:

- For shipment, the door handle has been stored inside of the unit binding to the wood shelves. To install the handle, the door gasket should be gently pulled back where it covers the screw holes for the handle, then the handle should be attached by screwing into place with the two screws which are packed in the box with this Instruction Manual and other spare parts.

Handle parts	Diagram	Use
Screws x4		For handle installation
Washers x4		For handle installation

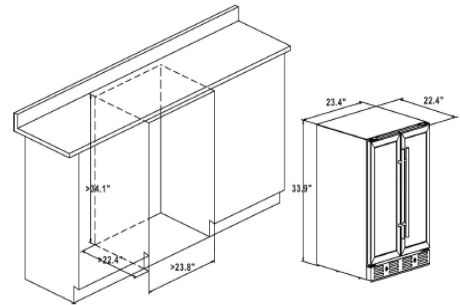
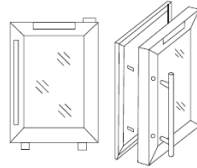

INSTALLATION AREA.

• Operating Your Wine Cooler

• The Control Panel:

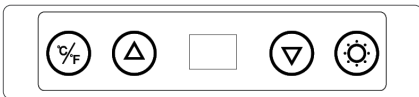

- To switch the temperature display from Degree Celsius to be Degree Fahrenheit or vice versa, press C/F button.
- To control the left temperature zone, press UP or DOWN button on the left side. Each press would adjust the temperature by 1°C between 5~18°C or 1°F between 40~66°F.
- To control the right temperature zone, press UP or DOWN button on the right side. Each press would adjust the temperature by 1°C between 5~18°C or 1°F between 40~66°F.
- To turn on or off the internal LED lighting, press LIGHT button on the right side.

• DEFROSTING

- The surface of the evaporator ices up when the refrigerator is working. This is an entirely normal part of operation. If the frost layer is more than 3mm (1/4") thick, the refrigerator must be defrosted and cleaned to avoid unnecessary energy consumption and inefficient operation.
- Remove all items inside and unplug the refrigerator. After defrosting, clean the refrigerator and allow it to dry. Reconnect to the mains supply and run the refrigerator.

• Maintenance

- Cleaning your wine cooler
- Unplug the wine cooler and remove the bottles.
- Wash the inside with warm water or baking soda solution. The solution should be about 2 tablespoons of baking soda to a quart of water.
- The outside of wine cooler should be cleaned with mild detergent or warm water.

• Moving your wine cooler

- Remove all the bottles.
- Securely tape down all loose items inside your wine cooler.
- Turn the levelling legs up to the base to avoid damage.
- Tape the door.
- Be sure the wine cooler stays in the upright position during transportation.

• Troubleshooting

- You can solve many common wine cooler problems easily, saving you the cost of a possible service call. Try the suggestion below to see if you can solve the problem before calling the service centre.

PROBLEM	CAUSE	PROBLEM	CAUSE	PROBLEM	CAUSE
Wine cooler does not function.	Not plugged in using different voltage. The circuit breaker tripped or a blown fuse.	The wine cooler seems to make too much noise.	The wine cooler is not levelled. Check the fan.	Buttons are not functional.	Temperature controller panel is damaged.
Wine cooler is not cold enough.	Check the temperature control setting. The door is open too often. The door is not closed completely. The door seal does not seal properly. The wine cooler does not have the correct Clearance.	The door will not close properly.	The wine cooler is not levelled. The doors were reversed and not properly installed. The seal is weak. The shelves out of position.		
The light does not work.	Main control board does not work. PCB Problem. There is some problem with the plug.	LED could not display.	Main control board does not work. PCB Problem. There is some problem with the plug.		
Vibrations.	Check to assure that the wine cooler is levelled.	LED display error.	Weak quality of display. Temperature point is out off.		



Environment Protection, Waste Electrical and Waste Electronic Equipment Regulations (WEEE)



Recycle unwanted packaging materials. When this product is no longer required, or has reached the end of its useful life, please dispose of in an environmentally friendly way. Drain any fluids (if applicable) into approved containers, in accordance with local waste regulations. It is our policy to continually improve products and we reserve the right to alter data, specifications and parts without prior notice. No liability is accepted for incorrect use of this product. Guarantee is 12 months from purchase date, proof of which is required for any claim.

Dellonda Limited, Sole UK Distributor of Baridi

Kempson Way, Suffolk Business Park, Bury St Edmunds, Suffolk. IP32 7AR



01284 757575



support@dellonda.co.uk



www.dellonda.co.uk