

# baridi

## Baridi 60cm 4 Zone Induction Hob, Boost Function, 9 Power Levels, Touch Control, Timer, 6800W

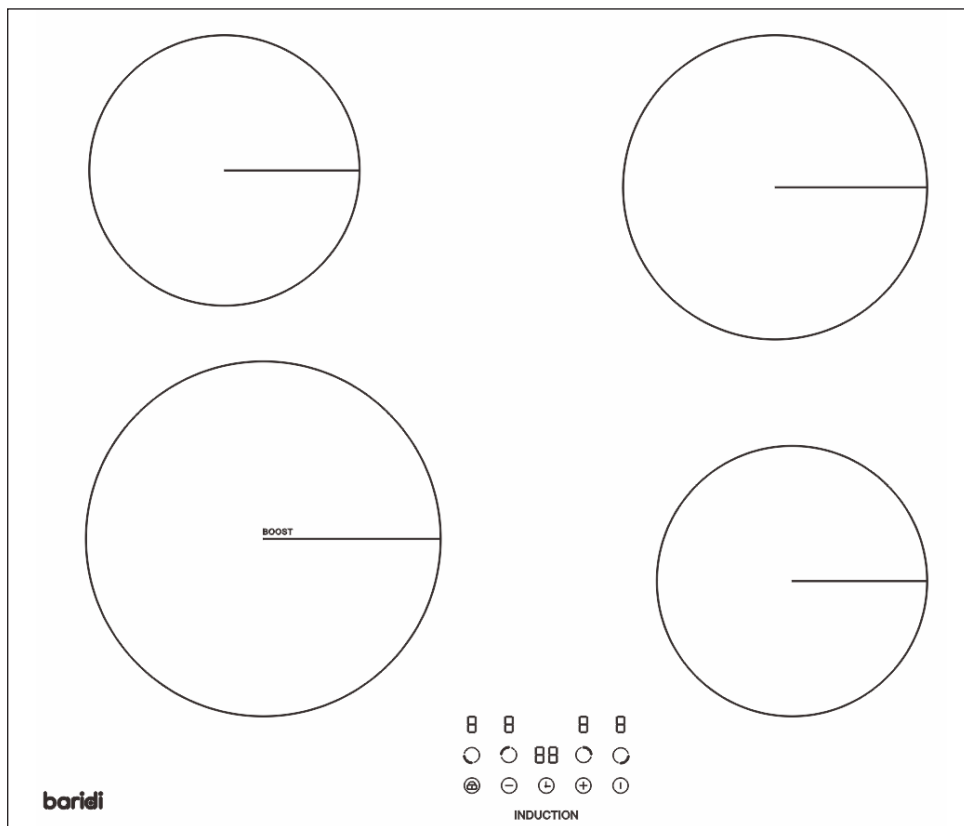

### Model No. DH176

Thank you for purchasing a Dellonda product. Manufactured to a high standard, this product will, if used according to these instructions, and properly maintained, give you years of trouble free performance.

## Important Information

Please read these instructions carefully. Note the safe operational requirements, warnings & cautions. Use the product correctly and with care for the purpose for which it is intended. Failure to do so may cause damage and/or personal injury and will invalidate the warranty. Keep these instructions safe for future use.



Refer to  
instruction  
manual



Warning:  
Hot  
Surface



Warning:  
Can cause  
Fire



Indoor use  
Only



Warning:  
Electricity

## SPECIFICATION

Cable Length: ..... 1m  
 Colour: ..... Black  
 Installation: ..... Built In  
 Number of Hobs: ..... 4  
 Power: ..... 6800W  
 Product dimensions: ..... 590 x 520 x 60mm  
 Supply: ..... 220-240V  
 Surface: ..... Ceramic Glass  
 Type: ..... Induction

## SAFETY INSTRUCTIONS

### • ELECTRICAL SAFETY

- Dellonda recommend that installation and repairs are carried out by a suitably qualified electrician.
- **WARNING!** It is the user's responsibility to check the following:
- Check all electrical equipment and appliances to ensure that they are safe before using. Inspect power supply leads, plugs and all electrical connections for wear and damage. If the product is used in the course of business duties, it must be maintained in a safe condition and routinely PAT (Portable Appliance Test) tested.
- **ELECTRICAL SAFETY INFORMATION:** It is important that the following information is read and understood.
- **IMPORTANT:** The appliance must **NOT** be connected to the mains supply by means of a 13A plug and socket.
- This appliance must be wired into a 32A double pole switched fused spur outlet, having 3 mm contact separation and placed in an easily accessible position adjacent to the appliance. It should not be located above the appliance and no more than 1.25m away from it.
- The "blue" "Grey" neutral wire must be connected to the terminal marked with letter (N) - the "black" "brown" live wire must be connected to the terminal marked with letter L (220-240V 1N~). see Fig.1.
- Ensure that the insulation on all cables and on the appliance is safe before connecting it to the power supply.
- Regularly inspect power supply cables and plugs for wear or damage and check all connections to ensure that they are secure.
- The cable can be looped if necessary, but make sure that is not kinked or trapped when the hob is in position. Care must be taken to avoid the cable being in contact with hot parts of the appliance.
- **IMPORTANT:** Ensure that the voltage rating on the appliance suits the power supply to be used and that the unit is wired in accordance with these instructions.
- **DO NOT** pull the appliance by the power cable.
- **DO NOT** use worn or damaged cables.
- Ensure that any faulty item is repaired or replaced immediately by a suitably qualified electrician.

### • GENERAL SAFETY

- The appliance and its accessible parts become hot during use. Care should be taken to avoid touching heating elements.
- This appliance can be used by children aged from 8 years and above and persons with reduced physical, sensory or mental capabilities or lack of experience and knowledge or they have been given supervision or instruction concerning use of the appliance in a safe way and understand the hazards involved. Children shall not play with the appliance. Cleaning and user maintenance shall not be made by children without supervision.
- A steam cleaner is not to be used.
- Accessible parts may become hot during use. Young children should be kept well away when in use.
- **DO NOT** use abrasive products to clean the ceramic surface to avoid scratching it. Otherwise, severe failure might happen to the appliance.

### • OPERATIONAL SAFETY

- **DO NOT** allow paper or cloth to come in contact with any heating element.
- It is specifically designed for use when heating or cooking food. The use of corrosive chemicals in heating or cleaning will damage the appliance and could result in injury.
- If food being prepared should ignite, switch off the hob and disconnect from supply power.
- Only use utensils that are suitable for use with ceramic hobs.
- **WARNING! DANGER OF EXPLOSION!** Liquids and other foods must not be heated in sealed containers since they are liable to explode.
- **DO NOT** allow any accessories or electric cables to contact the hot parts of the appliance.
- **HOT SURFACES! RISK OF BURNS!** During use the appliance becomes hot.
- **WARNING!** Accessible parts may become hot during use. Young children should be kept away.
- Never move racks or pans when they are hot. Wait until they cool.

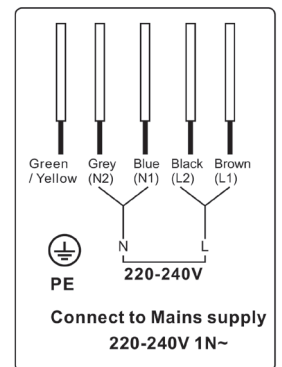
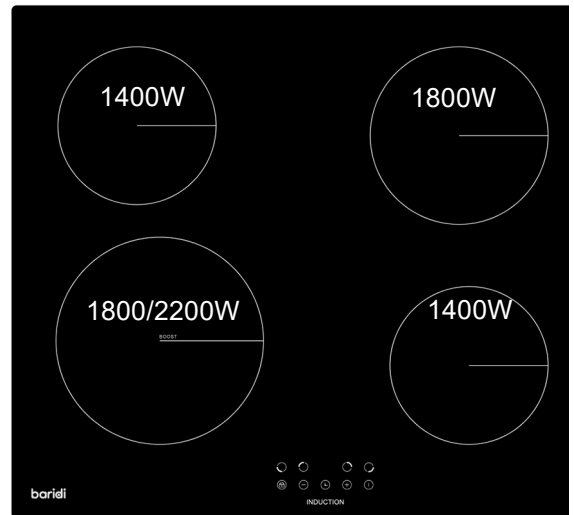

fig.1

- **IMPORTANT!** Always switch off the electricity supply at the mains during installation and maintenance.
- **DO NOT** use the ceramic hob until you have read this instruction manual.
- The ceramic hob is intended for household use only.
- Ensure that small items of household equipment, including connection leads, do not touch the hob as the insulation material of this equipment is usually not resistant to high temperatures.
- **DO NOT** leave the ceramic hob unattended when frying. Oils and fats may catch fire due to overheating or boiling over.
- **DO NOT** switch on the hob until a pan has been placed on it.
- **DO NOT** put pans weighing over 25kg on the hob.
- **DO NOT** use the ceramic hob in the event of a technical fault. Any faults must be fixed by an appropriately qualified and authorized person.
- In the event of any incident caused by a technical fault, disconnect the power and report the fault to the service centre to be repaired.

## • GENERAL INFORMATION

- This appliance is designed for domestic household use and must be built into a standard kitchen cabinet or housing unit.
- The appliance surfaces will become hot during use and retain heat after operation.
- Please dispose of the packaging material carefully. Packaging material can be dangerous to children.
- **DO NOT** allow cable to come into contact with the heating areas of appliance.
- **DO NOT** install the appliance next to curtains or soft furnishings.
- The appliance must be placed in such a way that the power supply is accessible at all times.
- Before connecting the appliance to the power supply, check that the power supply voltage and current rating corresponds with the power supply details shown on the appliance rating label.
- Never use a damaged appliance! Disconnect the appliance from the power source and contact your supplier if it is damaged.
- Danger of electric shock! Do not attempt to repair the appliance yourself. In case of malfunction, repairs are to be conducted by suitably qualified personnel only.
- To avoid damaging the cord, do not squeeze, bend or chafe it on sharp edges. Keep it away from hot surfaces and open flames as well.
- Lay out the cord in such a way that no unintentional pulling or tripping over it is possible.
- **DO NOT** open the appliance casing under any circumstances. Do not insert any foreign objects into the inside of the casing.
- Always operate the appliance on a level, stable, clean and dry surface. Protect the appliance against heat, dust, direct sunlight, moisture, dripping and splashing water.
- **CLEANING**
- Always disconnect the power supply prior to cleaning the appliance. If the switched fused connection unit is difficult to reach, shut off the power supply by using the corresponding circuit breaker at the distribution board.
- Clean the appliance thoroughly before first use. The hob should be cleaned regularly and any food deposits removed.
- Never clean the hob surfaces by steam cleaning.
- The ceramic surface should only be cleaned with warm soapy water, using either a sponge or soft cloth. No abrasive cleaners should be used.
- Any stains that may appear on the ceramic surface will have originated from food splashes or spilt food, these splashes occur during the cooking process. These could possibly be a result of the food being cooked at an excessively high temperature or being placed in cookware that is too small.

## • INSTALLATION

### • ELECTRICAL CONNECTION

- Review and understand Safety Section 1 before installing this unit.
- Dellonda strongly recommend this work to be conducted by suitably qualified personnel only.
- Before connecting the appliance, make sure that the supply voltage marked on the Rating Plate corresponds with your mains supply voltage.
- **WARNING: THIS APPLIANCE MUST BE EARTHED.**
- **IMPORTANT:** The appliance must **NOT** be connected to the mains supply by means of a 13A plug and socket.
- This appliance must be wired into a 30A double pole switched fused spur outlet, having 3 mm contact separation and placed in an easily accessible position adjacent to the appliance. It should not be located above the appliance and no more than 1.25m away from it. See Fig.1.
- The "blue" "grey" neutral wire must be connected to the terminal marked with letter (N) - the "Black" "brown" live wire (L) must be connected to the terminal marked with letter (L) (220-240V 1N~). see Fig.1.
- The mains cable must not touch any hot metal.
- Care must be taken to ensure that the temperature of the mains supply cable does not exceed 50°C.
- If the mains supply cable is damaged, then it must be replaced by an appropriate replacement.

### • INSTALLING THE HOB INTO THE KITCHEN WORK SURFACE

- The kitchen area should be dry and aired and equipped with efficient ventilation. When installing the hob, easy access to all control elements should be ensured.

### • POSITIONING THE APPLIANCE SEE FIG.2 & FIG.3

- The kitchen units that are in direct contact with the appliances must be heat-proof (min. 95°C).
- The appliance can be installed on a work surface with a distance of between 30 and 40 mm and near to walls which are higher than the work surface, maintaining a minimum distance of 100 mm (see fig.3).
- Carry out all cutting of the unit and work surface then carefully remove shavings or sawdust before inserting the appliances.
- To ensure a correct ventilation of the hob please comply with the dimensions shown in fig.3.
- Minimum ventilation clearance requirements are 70cm above the hob, 5cm below the underside and 2cm from the rear (fig.3).
- Make sure the surface is level and square and that no part interferes with the space required for installation.
- Prepare the cut as indicated (see installation dimensions fig.2, fig.3).
- Hob requires a rectangular hole of 560mm wide by 490 mm deep.
- Refer to fig.2 and fig.3 for location .
- Apply the seal strip (supplied) to the underside edge of the hob, and leave approx. 3mm from the edge of the glass. **DO NOT** use silicone.
- Cut any excess and bring the two ends of the seal together so they match.

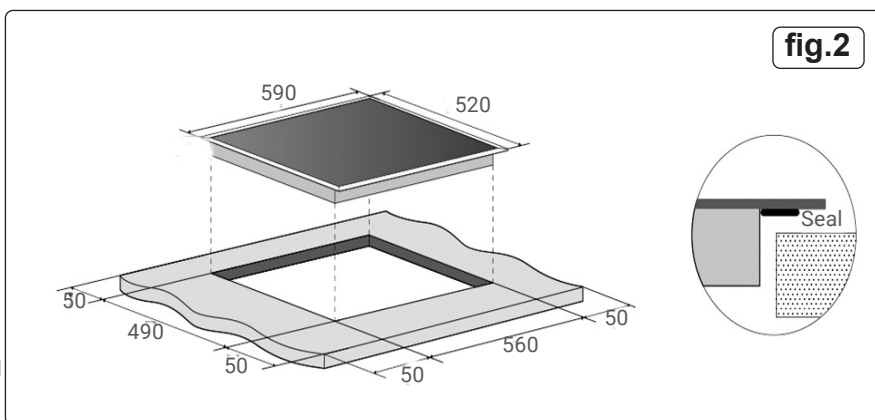

- Fix the brackets (4 pcs) on the front side and rear side by screw. Put the hob in the cut-out cabinet, and center it. Ensure that the front edge of the hob is parallel to the side edge of the work surface.
- **IMPORTANT:** You must observe the ventilation requirements shown in fig.3.
- **IMPORTANT:** There are ventilation spaces around the outside of the hob. **YOU MUST** ensure that these spaces are not blocked by the work top, when you put the hob into position (see fig.3).
- **IMPORTANT:** Do not use a silicon sealant to seal the appliance against the aperture. This will make it difficult to remove the hob from the aperture in future, particularly if it needs to be serviced.

## • OPERATION

### • CHOOSING THE CORRECT COOKWARE

- Only use cookware with a base suitable for induction cooking. Look for the induction symbol on the packaging or on the bottom of the pan.
- You can check whether your cookware is suitable by carrying out a magnet test. Move a magnet towards the base of the pan. If it is attracted, the pan is suitable for induction.
- If you do not have a magnet:
  1. Put some water in the pan you want to check.
  2. Follow the steps under 'to start cooking'.
  3. If the Incorrect Pot icon does not flash in the display and the water is heating, the pan is suitable.
- Cookware made by the following materials is not suitable: pure stainless steel, aluminium or copper without a magnetic base, glass, wood, porcelain, ceramic, and earthenware.
- **DO NOT** use cookware with jagged edges or a curved base.
- Make sure that the base of your pan is smooth, sits flat against the glass, and is the same size as the cooking zone. Always centre your pan on the cooking zone.

### • OPERATION

• **WARNING! IF A HEATING ZONE IS HOT, IT IS LABELLED . DO NOT TOUCH THE SURFACE.**

### • HEATING

- To turn the unit on, touch the On/Off button. The unit will 'beep', all indicators will light up for one second, go out and the unit will be in standby mode.
- Place a suitable pan on the cooking zone that you wish to use. Make sure the bottom of the pan and the surface of the cooking zone are clean and dry.
- Select the heating zone to be used and select a heat setting by using the Increase / Decrease button.
- Front left zone can be run in boost mode, which can be selected by touching the "+" control until the power level show "P".
- **NOTE:** If no heat setting is selected, the hob will turn off within one minute. The heat setting can be modified at any time during cooking.
- When you have finished cooking, select the zone and using the Decrease button return the setting to '0'.





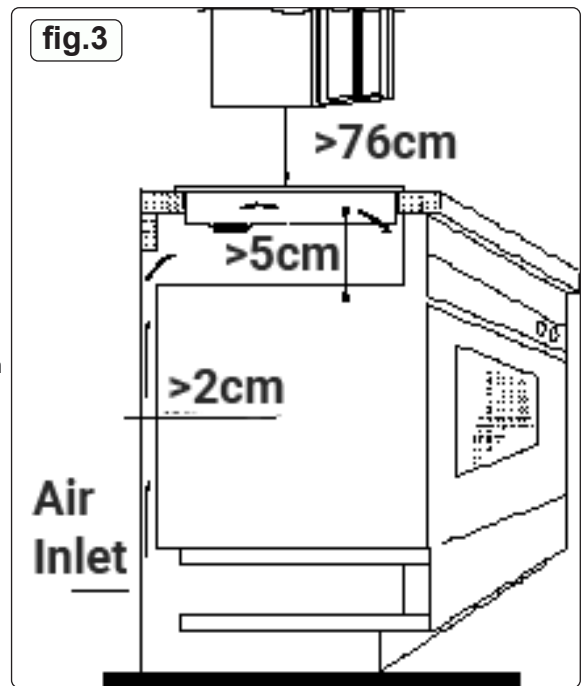

### • TIMING

- The timer can be used to simply measure time elapsed or to turn off a zone once the set time is reached. The timer can be set between 1 and 99 minutes.
- To measure time elapsed make sure the hob is turned on and no zone selection key is activated (zone indication '-' is not blinking).
- **NOTE:** you can set timer before or after cooking zone power setting finished.
- Touch Timer key, "00" will show in the timer display and the right hand "0" will blink.
- Set the time by touching the "+" "-" control of the timer. To set beyond 9 minutes, press the Timer key again and the left hand "0" will blink. Use the Increase / Decrease buttons to set your required time.
- When the time is set, it will begin to count down immediately. The display will show the remaining time.
- The buzzer will sound for 30 seconds and the timer indicator will show "--" when the set time has elapsed.
- To switch off one or more cooking zones firstly touch the heating zone selection control that you want to set the timer for.
- Set the time required as above i.e. "+" or "-" and count down will begin.
- **NOTE:** A red dot will appear against the relevant Zone Indicator to indicate which zone or zones are being timed.
- To cancel a Timer, touch the Zone control, touch the decrease control to set the timer to "0".
- To operate Child lock press the Lock symbol. Hold and touch the symbol to release the lock.

## • CLEANING

- Always disconnect the power supply prior to cleaning the appliance. If the switched fused connection unit is difficult to reach, shut off the power supply by using the corresponding circuit breaker at the distribution board.
- Clean the appliance thoroughly before first use. The hob should be cleaned regularly and any food deposits removed.
- Never clean the hob surfaces by steam cleaning.
- The hob ceramic should only be cleaned with warm soapy water, using either a sponge or soft cloth. No abrasive cleaners should be used.
- Any stains that may appear on the hob will have originated from food splashes or spilt food, these splashes occur during the cooking process. These could possibly be a result of the food being cooked at an excessively high temperature or being placed in cookware that is too small.
- You should select a cooking temperature and function that is appropriate for the food that you are cooking. You should also ensure that the food is placed in an adequately sized dish and that you use the drip tray where appropriate.



ICON	PURPOSE
	ON / OFF
	INCREASE SETTING
	CHILD LOCK
	TIMER SELECTION
	DECREASE SETTING
	ZONE INDICATOR
	INCORRECT POT

PROBLEM	SOLUTION	NOTE
Everyday soiling on glass (fingerprints, marks, stains left by food or non-sugary spills on the glass.	<ol style="list-style-type: none"> <li>1 Switch the power to the hob off.</li> <li>2. Apply a hob cleaner while the glass is still warm (but not hot!).</li> <li>3. Rinse and wipe dry with a clean cloth or paper towel.</li> <li>4. Switch the power to the hob back on.</li> </ol>	<ul style="list-style-type: none"> <li>• When the power to the hob is switched off, there will be no 'hot surface' indication but the cooking zone may still be hot! Take extreme care.</li> <li>• Heavy-duty scourers, some nylon scourers and harsh/abrasive cleaning agents may scratch the glass. Always read the label to check if your cleaner or scourer is suitable.</li> <li>• Never leave cleaning residue on the hob: the glass may become stained.</li> </ul>
Boilovers, melts, and hot sugary spills on the glass.	<p>Remove these immediately with a fish slice, palette knife or razor blade scraper suitable for ceramic glass hobs, but beware of hot cooking zone surfaces:</p> <ol style="list-style-type: none"> <li>1. Switch the power to the hob off at the wall.</li> <li>2. Hold the blade or utensil at a 30° angle and scrape the soiling or spill to a cool area of the hob.</li> <li>3. Clean the soiling or spill up with a dish cloth or paper towel.</li> <li>4. Follow steps above for everyday soiling on glass.</li> </ol>	<ul style="list-style-type: none"> <li>• Remove stains left by melts and sugary food or spillovers as soon as possible. If left to cool on the glass, they may be difficult to remove or even permanently damage the glass surface.</li> <li>• Cut hazard: when the safety cover is retracted, the blade in a scraper is razor-sharp. Use with extreme care and always store safely and out of reach of children.</li> </ul>
Spills on the touch panel.	<ol style="list-style-type: none"> <li>1. Switch the power to the hob off.</li> <li>2 Soak up the spill.</li> <li>3 Wipe the touch control area with a clean damp sponge or cloth.</li> <li>4. Wipe the area completely dry with a paper towel.</li> <li>5. Switch the power to the hob back on.</li> </ol>	The hob may beep and turn itself off, and the touch controls may not function while there is liquid on them. Make sure you wipe the touch control area dry before turning the hob back on.

## • TROUBLESHOOTING

PROBLEM	POSSIBLE CAUSE	SOLUTION
The hob cannot be turned on.	No power.	<p>Make sure the hob is connected to the power supply and that it is switched on.</p> <p>Check whether there is a power outage in your home or area. If you've checked everything and the problem persists, call a qualified technician.</p>
The touch controls are unresponsive.	The controls are locked.	Unlock the controls. See Operation section for child lock instructions.
The touch controls are difficult to operate.	<p>There may be a slight film of Water over the controls or you May be using the tip of your Finger when touching the Controls.</p>	Make sure the touch control area is dry and use the ball of your finger when touching the controls.
The glass is being scratched.	<p>Rough-edged cookware. Unsuitable, abrasive scourer or cleaning products being used.</p>	<p>Use cookware with flat and smooth bases. See 'Choosing the right cookware'.</p> <p>See 'Care and cleaning'.</p>

Some pans make crackling or clicking noises.	This may be caused by the Construction of your cookware (layers of different metals Vibrating differently).	This is normal for cookware and does not indicate a fault.
The induction hob makes a low humming noise when used on a high heat setting.	This is caused by the technology of induction cooking.	This is normal, but the noise should quieten down or disappear completely when you decrease the heat setting.
Fan noise coming from the induction hob.	A cooling fan built into your Induction hob has come on to Prevent the electronics from Overheating. It may continue to run even after you've turned the induction hob off.	This is normal and needs no action. Do not switch the power to the induction hob off at the wall while the fan is running.
Pans do not become hot and appears in the display.	The induction hob cannot Detect the pan because it is not suitable for induction cooking. The induction hob cannot detect the pan because it is too small for the cooking zone or not properly centred on it.	Use cookware suitable for induction cooking. See section 'Choosing the right cookware'. Centre the pan and make sure that its base matches the size of the cooking zone.
The induction hob or a cooking zone has turned itself off unexpectedly, a tone sounds and an error code is displayed (typically alternating with one or two digits in the cooking timer display).	Technical fault.	Please note down the error letters and numbers, switch the power to the induction hob off at the wall, and contact a qualified technician.

#### • ERROR CODES

ERROR CODE	TYPE OF FAULT	SOLUTION
E4/E5	Temperature sensor failure	Please contact the supplier
E7/E8	Temperature sensor of the IGBT failure.	
E2/E3	Abnormal supply voltage	Please inspect whether power supply is normal. Power on after the power supply is normal.
E6/E9	Bad induction hob heat radiation	Please restart after the induction hob cools down.

#### Environment Protection and Waste Protection and Electrical Equipment Regulations (WEEE)

Recycle unwanted packaging materials. When this product is no longer required, or has reached the end of its useful life, please dispose of it in an environmentally friendly way. Drain any fluids (if applicable) into approved containers, in accordance with local waste regulations. Under the Waste Batteries and Accumulators Regulations 2009, Dellonda would like to inform the user that this product contains one or more batteries. It is our policy to continually improve products and we reserve the right to alter data, specifications and parts without prior notice. No liability is accepted for incorrect use of this product. Guarantee is 12 months from purchase date, proof of which is required for any claim.

**Dellonda Limited**

Kempson Way, Suffolk Business Park, Bury St Edmunds, Suffolk. IP32 7AR

 01284 757575

 support@dellonda.co.uk

 www.dellonda.co.uk

## Information for domestic electric hobs

	Symbol	Value	Unit
Model identification		DH176	
Type of hob		Electric hobs	
Number of cooking zones and/or areas		4	
Heating technology (induction cooking zones and cooking areas, radiant cooking zones, solid plates)		Induction cooking	
For circular cooking zones or area: diameter of useful surface area per electric heated cooking zone, rounded to the nearest 5 mm	∅	Left down:21.0 Left up:16.0 Right down:16.0 Right up:18.0	cm
For non-circular cooking zones or areas: length and width of useful surface area per electric heated cooking zone or area, rounded to the nearest 5 mm	L W		cm
Energy consumption per cooking zone or area calculated per kg	EC <sub>electric cooking</sub>	Left down:189.7 Left up:193.6 Right down:190.9 Right up:185.4	Wh/kg
Energy consumption for the hob calculated per kg	EC <sub>electric hob</sub>	189.90	Wh/kg