

baridi

Baridi Steam Air Fryer Oven, Self-Cleaning, 8 Preset Programs, 1635W, 15L, Black

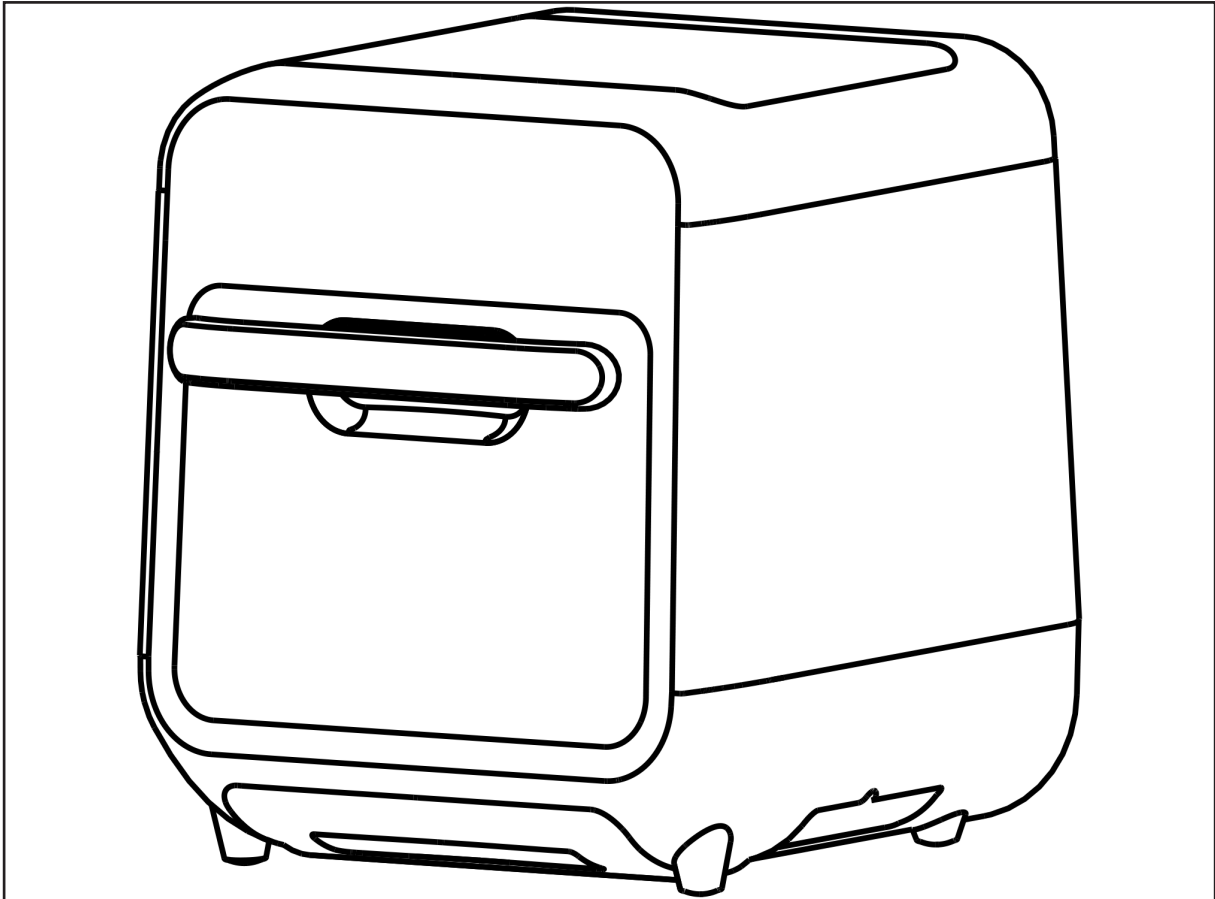

Model No. DH171

Thank you for purchasing a Dellonda product. Manufactured to a high standard, this product will, if used according to these instructions, and properly maintained, give you years of trouble free performance.

Important Information

Please read these instructions carefully and note any safe operational requirements, warnings & cautions. Use the product correctly and with care for the purpose for which it is intended. Failure to do so may cause damage and/or personal injury and will invalidate the warranty. Keep these instructions safe for future use.



Refer to
instruction
manual



Warning:
Hot
Surface

SAFETY INSTRUCTIONS

• ELECTRICAL SAFETY

- **WARNING!** It is the user's responsibility to check the following:
- Check all electrical equipment and appliances to ensure that they are safe before using. Inspect power supply leads, plugs and all electrical connections for wear and damage. Baridi recommend that an RCD (Residual Current Device) is used with all electrical products. You may obtain an RCD by contacting your local domestic stockist. If the product is used in the course of business duties, it must be maintained in a safe condition and routinely PAT (Portable Appliance Test) tested.
- **Electrical safety information:** It is important that the following information is read and understood.
- Ensure that the insulation on all cables and on the appliance is safe before connecting it to the power supply.
- Regularly inspect power supply cables and plugs for wear or damage and check all connections to ensure that they are secure.
- **Important:** Ensure that the voltage rating on the appliance suits the power supply to be used and that the plug is fitted with the correct fuse - see fuse rating in these instructions.
- **DO NOT** pull or carry the appliance by the power cable.
- **DO NOT** pull the plug from the socket by the cable.
- **DO NOT** use worn or damaged cables, plugs or connectors.
- Ensure that any faulty item is repaired or replaced immediately by a qualified electrician.
- This product is fitted with a BS1363/A 3 pin plug. If the cable or plug is damaged during use, switch off the electricity supply and remove from use. Ensure that repairs are carried out by a qualified electrician.
- Replace a damaged plug with a BS1363/A 3 pin plug. If in doubt contact a qualified electrician.
 - A) Connect the GREEN/YELLOW earth wire to the earth terminal 'E'.
 - B) Connect the BROWN live wire to the live terminal 'L'.
 - C) Connect the BLUE neutral wire to the neutral terminal 'N'.
- Ensure that the cable outer sheath extends inside the cable restraint and that the restraint is tight.
- Dellonda recommend that installation and repairs are carried out by a qualified electrician.

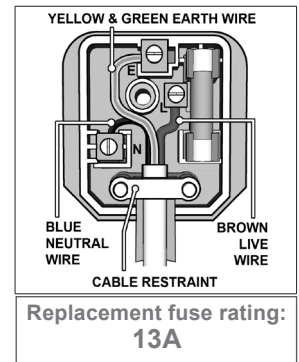

• GENERAL SAFETY

- When using electrical appliances with various functions, please follow these basic safety precautions to ensure you don't damage the unit or cause personal injury.
- **WARNING!** Unplug the appliance from the power outlet when not in use and before cleaning.
- **MAKE SURE THERE IS WATER IN THE TANK BEFORE YOU USE THE STEAM FUNCTION. THE TANK IS LOCATED UNDER THE UNIT.**
- **MAKE SURE YOU CHANGE THE WATER IN THE TANK AFTER USE TO AVOID CONTAMINATION AND STALE ODOURS.**
- **DO NOT** touch hot surfaces. Use handles, oven mitts or potholders.
- To protect against electric shock **DO NOT** immerse the cord, plugs, or appliance in water or other liquid.
- All users of this appliance should read and understand this instruction manual before operating or cleaning this appliance.
- Allow to cool before putting on or taking off parts, and before cleaning the appliance.
- **DO NOT** operate the appliance if it has malfunctioned or has been damaged, including the power cord or plug. If the power cord is damaged, it must be replaced by the manufacturer, its service agent or qualified technician in order to avoid a hazard.
- The use of accessory attachments not recommended by the appliance manufacturer may cause injuries and void the product warranty.
- **DO NOT** use outdoors.
- **DO NOT** let the cord hang over the edge of tables or counters, or touch hot surfaces.
- **DO NOT** place on or near a hot gas or electric burner, or in a heated oven.
- **DO NOT** move the appliance while containing hot oil or other hot liquids.
- **DO NOT** use the appliance for other than intended use.
- This appliance is not intended for use by persons (including children) with reduced physical, sensory or mental capabilities, or lack of experience and knowledge, unless they are being supervised or given instruction concerning use of the appliances by the person responsible for their safety.
- Children should be supervised to ensure that they **DO NOT** play with the appliance.
- Close supervision is necessary when your appliance is being used near children or infants.
- This appliance is intended for household use only, it is not warranted for use in a commercial or business application.
- The Steam air fryer will not operate unless the unit door is fully closed.
- After hot air frying, extreme caution must be used when handling the hot frying tray, removable airflow tray and cooked foods.
- **DO NOT** use on acrylic or stone surfaces as heat may cause cracks or surface damage. **DO NOT** place directly in front of glass splashbacks. Leave a minimum of 10cm from the rear of the unit.
- This appliance generates heat and escaping steam during use. Proper precautions must be taken to prevent the risk of burns, fires, or other injury to persons or damage to property. Keep your face and hands away from heat or steam outlets.
- This appliance will become hot during operation and retain heat after turning OFF.
- Always use oven mitts when handling hot materials and allow metal parts to cool before cleaning.
- **DO NOT** place anything on top of the appliance while it is operating or while it is hot.
- The cord to this appliance should be plugged into a 220- 240V AC electrical outlet only.
- If this appliance begins to malfunction during use, if safe, remove the food and the tray from the cavity of the unit.

Then remove the plug from the wall outlet. **DO NOT** use or attempt to repair the malfunctioning appliance.

- **DO NOT** leave this appliance unattended during use.
- Keep the cord out of reach of children and infants to avoid the risk of electric shock and choking.
- **DO NOT** obstruct the air outlet or air inlets on the back and sides of the Steam air fryer with any objects. Avoid escaping steam from the air outlet during air frying.
- Keep the appliance at least 15 cm away from walls or other objects during operation.
- After air frying, make sure to place the cooking tray on a flat, heat-resistant surface.
- Make sure the door is closed to use the air fryer function. Open the door to move or turn over the food.
- Hot oil can collect at the base of the tray. To avoid risk of burns or personal injury, or to avoid oil from contaminating air fried foods, always remove the tray before emptying.
- Over-filling the cooking cavity may damage the Steam air fryer and could result in serious personal injury. Please use your judgment and keep within the specified capacity and spacings specified in this manual.
- **NEVER** move the unit while in use.
- **DO NOT** clean with metal scouring pads. Pieces can break off the pad and touch electrical parts, creating a risk of electric shock.
- This Steam air fryer should not be used to boil water or to deep fry food.
- During first use, the Steam air fryer may emit a slight odour. This is normal and will not affect the flavour or air convection frying.

CONTENTS

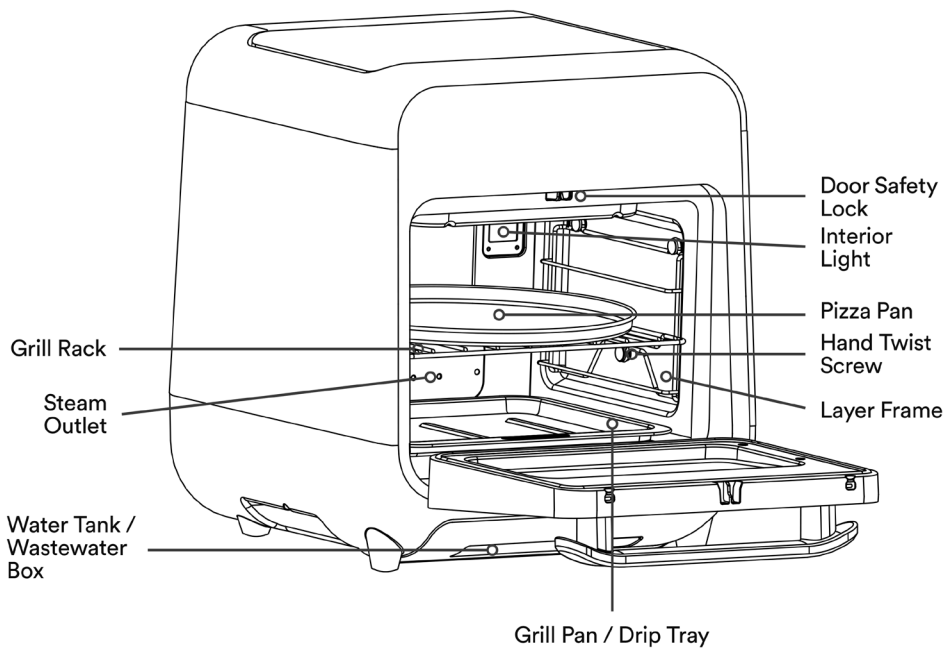

WHAT'S IN THE BOX:

- Air fryer
- Manual
- Grill pan/drip tray
- Grill rack
- Pizza pan
- Airflow tray

BEFORE USING FOR THE FIRST TIME

- Remove all packing material and labels from the inside and outside of the Steam air fryer. Check that there is no packaging underneath and around the trays.
- Before you use for the first time - fill the water tank with water and insert the water tank into the slot, which is under the unit.
- **NOTE:** Before using the appliance for the **FIRST TIME**, we recommend you to run the self-cleaning mode to clean the steam generator system thoroughly. This will take roughly 60 minutes to complete. **DO NOT** place food in the unit until it has completed. Please refer to the Self Cleaning Function section in this manual.
- After the self-cleaning function has finished, switch off the oven. Once it has cooled down, wipe down the oven cavity. Your Steam air fryer is now ready to use.
- **DO NOT IMMERSE THE STEAM AIR FRYER BODY IN WATER.** Wipe the Steam air fryer body with a damp cloth. Dry all parts thoroughly.
- **NOTE:** During first use, the Steam air fryer may emit a slight odour. This is normal and will not affect flavour or air frying.
- **CAUTION - HOT SURFACES:**
- This appliance operates at high temperatures. **DO NOT** touch external surfaces of the appliance as they can be hot. **DO NOT** touch inside the appliance while it is in operation.
- During operation, hot steam is released through the hot air outlets. Please keep your hands and face away from the steam and air outlets.

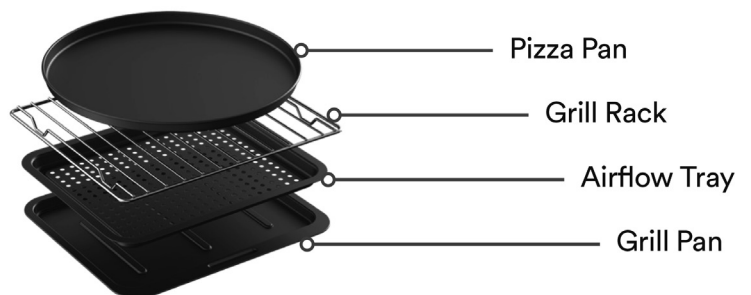



BASIC SETTINGS

	TEMPERATURE CONTROL		TIME CONTROL
	START/PAUSE BUTTON		ON/OFF POWER BUTTON



AIR FRYER PRESETS

	FRIES		PIZZA
	MEAT		CHICKEN WINGS
	FISH		VEGETABLES
	DEHYDRATE		BAKE

COOKING MODES & VISIBLE ALERTS

	DIY FUNCTION		AIR FRY MODE
	STEAM & AIR FRY COMBO MODE		FULL STEAM MODE
	STEAM+ (Add steam manually during operation)		INSUFFICIENT WATER (Indicator to fill the water tank)
	LIGHT ON/OFF		

STEAM OVEN QUICK START GUIDE (REFER TO SYMBOLS ON OPPOSITE PAGE)

- Please follow the below steps to get cooking quickly, although results may vary.
We recommend reading this manual thoroughly.
- 1. Plug in the Steam air fryer. The buttons will turn on and off and the unit will make a tone, then the red power button will stay lit, indicating the unit is ready.
- 2. Press the red On/off button. It will turn green (MENU MODE) once pressed.
- 3. Pressing the  button will step through each of the cooking presets in sequence.
- MEAT > CHICKEN > FISH > SEAFOOD > CHIPS > VEGETABLE > DEHYDRATE > BAKE.
- 4. If you want to adjust the temperature or time adjust their respective buttons up/down.
- 5. To begin Air Frying press the power button. The other icons LIGHT, MENU,  POWER and START/PAUSE will continue to be lit whilst the other cooking presets will be turned off.

AIR FRY MODE

- The Air Fryer cooks food that is often deep fried, giving you the crunch without much oil. Things like frozen chicken bites, frozen fries and even air fried salmon work well. The AIR FRY function combines intense heat and maximised airflow to cook foods crispy and brown.
- **HOW TO USE AIR FRY MODE**
- 1. Arrange food evenly on one of the included trays.
- 2. For best results, place food in a single layer and leave space between pieces. Insert the tray into the top rack height position.
- 3. Close the oven door.
- 4. Touch the AIR FRY icon, it will flash once selected.
- 5. The AIR FRY temperature, time and convection settings can be adjusted before and during the AIR FRY cycle.
- 6. The AIR FRY temperature is displayed as the left figure on the screen. Press the and icons to adjust the AIR FRY temperature.
- 7. Touch the START/CANCEL icon to activate the AIR FRY function. The AIR FRY icon will remain illuminated, and the timer will automatically begin to count down.
- **NOTE:** It is advised that you use the Grill Pan/Drip Tray underneath the air fry tray to catch the oil drippings. Discard excess oil in between the batches.

STEAM & AIR FRY COMBO MODE

- The Steam & Air Fry Combo Mode is best used to cook roast chicken that needs a crispy skin or dumplings.
- In this mode, the air fryer works first to heat the food. When the temperature reaches 200°C, the steamer will automatically turn on. The air fryer and the steamer will work alternatively to provide continuous circulation of hot air and steam. This keeps the food tender and juicy on the inside while still golden and crispy on the outside. In this mode, the unit will generate steam that will enter into the oven cavity to cook the food. Steaming the food helps preserve the natural flavours and nutritional value of the food.
- **HOW TO USE:**
- 1. Fill the water tank to the maximum level with water only.
- 2. Make sure the water tank's cap is secure and locked.
- 3. Re-attach the water tank on the underside of the unit.
- 4. Place the food on a tray and into the steam air fryer.
- 5. Select AIR FRYER-STEAM icon on the touchscreen panel to start the Air Fry & Steam process.
- 6. The default cooking time is 30 minutes. Adjust the desired cooking time by pressing the or time buttons.
- 7. When you hear the timer sound, the cooking has finished.
- 8. Check if the food is ready. If the food is not ready yet, put it back in the steam air fryer and set the timer for a few extra minutes.

FULL STEAM MODE

- The Full Steam Mode is best used to cook fish, vegetables and dumplings.
- In this mode, the unit will generate steam that will enter into the oven cavity to cook the food. Steaming the food helps preserve the natural flavours and nutritional value of the food.
- **HOW TO USE:**
- 1. Fill the water tank to the maximum level with water only before use.
- 2. Make sure the water tank's cap is secure and locked.
- 3. Re-attach the water tank on the underside of the unit.
- 4. Place the food on a tray and into the steam air fryer.
- 5. Select STEAM icon on the touchscreen panel to start the Steam process.
- 6. The default cooking time is 30 minutes. Adjust the desired cooking time by pressing time up or down buttons.
- 7. When you hear the timer sound, the cooking has finished.
- 8. Check if the food is ready. If the food is not ready yet, put it back in the steam air fryer and set the timer for a few extra minutes.
- **NOTE:** To cook steamed vegetables, you can directly select the cooking program. The temperature and cooking time will be automatically set up. When  is flashing, it indicates that the water tank is empty. Refill the water tank with water. We recommend using purified water.











DIY FUNCTION

- The DIY function is a combination of the full steam and air fry modes. In comparison to the steam & air fry combo, the DIY function enables you to adjust the time and temperature for each mode separately. By using the temperature and timer settings you can adjust the unit to cook as desired.
- **HOW TO USE:**
- 1. After the oven is switched on, press the DIY button to customise your cooking mode.
- 2. Press Time Setting to adjust the time to your preferences to add Full Steam Mode.
- 3. Press the DIY Button again. Both the DIY and the Air Fry Mode Button will flash.
- 4. Adjust the Temperature and Time Setting buttons to adjust for these values on the Air Fry mode.
- 5. Press Start/Pause to begin.
- **TIP:** To adjust the temperature and time setting during operation, please press the Start/Pause Button to pause operation first.

STEAM + FUNCTION

- The Steam + function is used to add steam manually during operation of the Air Fry Mode and the 8 presets. It can not be used in the Full Steam Mode, Steam and Air Fry Combo Mode and DIY Function.
- HOW TO USE:**
- While cooking, press the STEAM + button . It will emit steam for 1 minute and then revert back to standard air frying. To add more steam, press the STEAM + button again.

PRESET COOKING MODES

	PRESET FUNCTIONS	TIME (Min)		TEMP (°C)		ADDITIONAL HUMIDIFICATION FUNCTION
		Default	Range	Default	Range	
	FRIES	20min	1-60min	200°C	40-200°C	Optional
	PIZZA	10min	1-60min	180°C	40-200°C	Optional
	MEAT	15min	1-60min	190°C	40-200°C	Optional
	CHICKEN	20min	1-60min	190°C	40-200°C	Optional
	FISH	15min	1-60min	190°C	40-200°C	Optional
	DEHYDRATE	480min	60-1600min	50°C	40-80°C	Optional
	VEGETABLES	10min	1-60min	150°C	40-200°C	Optional
	BAKE	30min	1-60min	160°C	40-200°C	Optional
	FULL STEAM MODE	30min	1-30min	100°C	Non-Adjustable	Non-Optional
	STEAM & AIR FRY COMBO MODE	30min	1-30min	150°C	40-200°C	Non-Optional
	AIR FRY MODE	30min	1-60min	200°C	40-200°C	Optional

COOKING TIPS & INSTRUCTIONS

- The Steam air fryer door needs to be fully closed to cook properly, but the unit will continue to cook even if left slightly ajar. This is not a design feature, and is an unsafe way to cook. We encourage you to ensure the door is closed and locked during use to ensure cooking quality and to protect your safety.
- Please refer to the Air Frying Chart and/or follow the package directions for the suggested cooking TIME, TEMP and cooking modes. All preset and cooking modes are pre-programmed with a default time and temperature. You can customise the TIME and TEMP settings by following Temperature and Time Settings (Optional) section, in this manual.
- If you want to use the steam function, fill the water tank before use. This will ensure there is enough water in the reserves for the steam generator to operate normally.
- TIP:** Use distilled water/soft drinking water instead of mineral water to help prevent the generation of scale within your steam air fryer.
- Once you have chosen the preset you desire, press the START/PAUSE button once. The button will begin to flash, and the default time & temperature will be displayed on the digital screen. This indicates that the preset function has been selected.
- Always use oven mitts when handling the Steam air fryer.
- Hot oil can pool at the base of the drawer. To avoid risk of burns or personal injury and to avoid oil from contaminating air fried foods, always ensure you remove the cooking tray before you empty it.
- Allow cooked food to rest for 5 to 10 minutes. Remove the tray from the machine and place on a flat, heat resistant surface.
- Always pat food dry before cooking to encourage browning and avoid excess smoke.
- For crispier results, air fry small batches of freshly crumbed food. Create more surface area by cutting food into smaller pieces. Bathe pieces of meat in egg and milk and then press bread crumbs onto the meat.
- Arrange crumbed food in the frying tray so that it is not touching to allow air flow on all surfaces.
- Spray oils work best because oil is distributed evenly and less oil is needed. Canola, olive, avocado, coconut, grapeseed, peanut, or vegetable oil all work well.
- Unplug the Steam air fryer when not in use.
- By default the viewing light is on. To turn off press the light button.
- You can adjust the cooking temperature and time by pressing the time control buttons. Pressing them adjusts the cooking time in 1 minute increments. Pressing temperature control buttons adjusts the cooking temperature in 5°C increments.
- When in dehydrate mode, the time adjustment will be in hourly increments.
- While cooking, you can look in the viewing window at any time to see the progress, however if you need to pause the Steam air fryer press the START/PAUSE button. The START/PAUSE button will flash until cooking resumes. Press the START/PAUSE button again to resume cooking.

- 17. When paused, it is normal that the fan will keep running for 20 seconds.
- 18. If the door is not closed within 5 minutes, all buttons and icons will turn off and the unit will turn off.
- 19. When cooking time is complete, the unit will beep once and the display will show "END". The fan will continue to run for 20 seconds to cool down and return to standby mode.
- 20. If you want to stop cooking, please hold down the power ON/OFF button for 3 seconds.

TEMPERATURE & TIME SETTINGS (OPTIONAL)

- Once the preset or cooking mode is selected, the default temperature and time setting will be shown on the digital display screen. You can adjust the temperature by pressing the temperature settings buttons and to decrease or increase.
- To adjust the time, simply press the time control buttons to decrease or increase the cooking time.
- **NOTE:** Adjustable temperature range: 40-200°C.
- Short press the temperature setting buttons to increase/decrease the temperature by 5°C each time. Press and hold the temperature settings button (for 3 seconds) to increase/decrease the temperature rapidly by 5°C.
- Adjustable time range: 1-60mins.
- Short press the time setting buttons to increase/decrease the time by 1 minute each time. Press and hold the time setting buttons (for 3 seconds) to increase/decrease the time by 5 minutes each time.
- **CAUTION:** The temperature setting is NOT adjustable when in FULL STEAM MODE.

START/PAUSE OPERATION

- When the preset or cooking mode is selected, the default time and temperature will flash.
- Press the START/PAUSE button to start cooking.
- Short press the START/PAUSE button to pause the cooking.
- When cooking is paused, the START/PAUSE button, and the cooking mode/preset button will flash, and the timer will also stop counting.
- To resume cooking, short press the START/PAUSE button again.
- The buttons will stop flashing and the digital screen will continue timing.
- **NOTE:** If you open the door during the cooking time it will automatically pause the operation. To resume, close the oven door to continue cooking.
- To completely stop cooking, press and hold the ON/OFF button for 3 seconds.

MAINTENANCE NOTES

FILL WATER TANK REMINDER

- The **INSUFFICIENT WATER** button will flash when the water level is low and needs refilling.
- It will flash for 30 seconds, a buzzer will ring and the ERROR CODE E5 will appear.
- Take out the water tank from the underside of the unit, fill it with water and then re-insert it.
- Press the **INSUFFICIENT WATER** button to continue cooking.
- **DO NOT** fill the wastewater box, it may cause water to leak out during operation.

INTERIOR LIGHT

- •The light can be turned on or off during cooking by pressing the LIGHT ON/OFF button. It will automatically turn OFF after 30 seconds.
- •The interior light will automatically turn ON when you open the oven door, and turn OFF when you close the door.
- •To manually turn OFF the light when the oven door is open, press the LIGHT ON/OFF button.

SELF CLEANING FUNCTION

- The self-cleaning function is designed to clean any built-up scale inside of the steam generator. The entire process takes 60 minutes and it will clean in 3 stages:
- **DESCALER CLEANING | WATER CLEANING | DRYING**
- While you can use the self-cleaning method as often as you like, it is best to use the self-cleaning function before you use the unit for the first time, and after which "CLER" is shown on the digital display screen. This will display after 80 hours of use since the last clean was undertaken.
- Follow the below to use the self-cleaning mode function.
- 1. Take out the water tank from the bottom of the unit.
- 2. Fill the water tank with clean water or descaler as specified on the container. We strongly advise using a food-grade descaler such as citric acid powder to clean.
- 3. Insert the water tank back into the unit and turn ON. If you are using the oven for the first time, you can use just clean water for the first self-clean.
- 4. Press and hold the (STEAM+) button for 5 seconds to start the self-cleaning function, working its way through STAGES 1-3:
- **STAGE 1: DESCALER CLEANING.** During this stage, the digital display screen will show "CL:01". The START/PAUSE button will begin to flash and the screen will show "CL:02" as it goes into the next phase.
- To finish this section of cleaning, you will need to empty and refill the water tank within 5 minutes after the 1st stage (Descaler Cleaning) has completed.
- Once this stage has completed a buzzer will sound. You will notice "CL:02" displayed on the digital screen. After you have refilled the water, press the START/PAUSE button to start the 2nd and 3rd stages. If you miss this step - the self-cleaning function mode will cancel and you will need to restart again.
- Once the setup is complete for STAGE 2, press the flashing START/PAUSE button to initiate the clean. It will automatically cycle through to STAGE 2 and STAGE 3.
- At the conclusion of STAGE 3, the buzzer will sound and the digital display screen will show END.

A NOTE ON AIR FRYING PRE-PACKAGED FROZEN FOODS

- 1. Where microwave ovens often produce hot, mushy results and toaster ovens can be slow to cook, air frying delivers fast, crispy results.
- 2. As a rule (depending on the food and amount to be cooked), the suggested cook TIMES may have to be reduced slightly. Always check food halfway through cooking time to determine final cook TIME and TEMP.
- 3. Always check cooking progress after TIME has expired.

AIR FRYING CHART

- Times are estimated and based on average sizes and weights. Always use a meat thermometer to ensure that meat, poultry and fish are cooked thoroughly before serving.
- Frying smaller batches will result in shorter cooking times and higher food quality. Adjust air frying temperatures and times as necessary to suit your taste.
- Unless food is pre-packaged and pre-oiled, for browned and crispy results, all foods should be lightly oiled before air frying.

DISH	COOKING MODE	TEMP	TIME
Steamed Corn	Full Steam Mode	100°C	30 min
Steamed Bread	Full Steam Mode	100°C	15 min
Steamed Egg	Full Steam Mode	100°C	12 min
Steamed Fish	Full Steam Mode	100°C	15 min
Steamed Pork Ribs	Full Steam Mode	100°C	20 min
Steamed Sweet Potato	Full Steam Mode	100°C	30 min
Steamed Shrimp	Full Steam Mode	100°C	8 min
Pizza	Steam and Air Fry Combo Mode	180°C	10 min
Roasted Pork Ribs	Steam and Air Fry Combo Mode	200°C	20 min
Grilled Chicken	Steam and Air Fry Combo Mode	200°C	40 min

NORMAL OCCURANCES TO BE AWARE OF

SITUATIONS	CAUSE
Water is expelled from the steam outlet	This is normal. When the water tank is full, a small amount of water will be released from the steam outlet.
Water is expelled through the vent on the back of the oven.	After cooking, the pressure of the oven cavity is high. If the oven door is closed immediately, a small amount of water will be emitted from the vent. It is recommended to wait about 60 seconds after opening the oven door before closing it.
Steam condenses on the oven door.	When cooking, a small amount of steam will be generated on the inside of the oven. This in turn may condense on the oven door. After you have finished cooking, wipe the door and the glass with a dry cloth.
The fan continues running after cooking	Once you have finished cooking, due to the high temperature in the oven, the fan will continue to run in order to help with heat dissipation.

MAINTENANCE

- This appliance requires little maintenance. It contains no user-serviceable parts. Any servicing requiring disassembly other than cleaning must be performed by a qualified appliance repair technician.

CARE & CLEANING INSTRUCTIONS

WARNING! Allow the Steam air fryer to cool fully before cleaning. Always remove from mains supply before cleaning.

1. Unplug the Steam air fryer. Remove frying tray. Make sure the internal trays and accessories are cooled before cleaning.
2. Wash the trays in hot soapy water. **DO NOT** use metal kitchen utensils or abrasive cleansers or cleaning products.
3. The frying tray and removable airflow tray are dishwasher-safe. For best results, place them both on the rack of your dishwasher to clean.

4. Wipe the Steam air fryer body with a soft, non-abrasive damp cloth to clean.
5. The transparent window is glass and should only be cleaned when cool and the unit is off. It should only be cleaned by a warm cloth.

STORAGE INSTRUCTIONS

1. Make sure the Steam air fryer is unplugged and all of its parts are clean and dry before storing.
2. NEVER store the Steam air fryer while it is hot or wet.
3. Store the Steam air fryer in its box, in a clean, dry place.

TROUBLESHOOTING

PROBLEM	POSSIBLE CAUSE	SOLUTION
The Steam Oven doesn't work	<ul style="list-style-type: none"> • The power plug is not connected properly. • The door may not be closed correctly. • The household circuit breaker has switched off or tripped. • The watertank is not put back in correctly or is empty. 	<ul style="list-style-type: none"> • Plug the cord into the wall outlet. To begin, press the  button.
Food is not cooked	<ul style="list-style-type: none"> • The frying tray is overloaded. 	<ul style="list-style-type: none"> • Cook smaller batches of food. • Shake food 2 OR 3 TIMES during cooking. • Increase TEMPERATURE. • Increase AIR FRY TIME.
Food is not fried evenly	<ul style="list-style-type: none"> • The frying tray is overloaded. 	<ul style="list-style-type: none"> • Air fry smaller batches of food. • Apply a light even coat of spray oil to food before frying. • Shake foods 2 OR 3 TIMES during the cooking process.
Frying tray won't slide into the Steam air fryer body properly	<ul style="list-style-type: none"> • The frying tray is overloaded. 	<ul style="list-style-type: none"> • Air fry smaller batches of food.
White smoke is expelled from the Steam air fryer	<ul style="list-style-type: none"> • The Steam air fryer is overloaded with oil. • The frying tray and drawer have not been cleaned. 	<ul style="list-style-type: none"> • When frying oily foods, such as bacon, you may need to clean out the frying tray more often. • Clean the frying tray after each use.
Fresh potato fries are not fried evenly	<ul style="list-style-type: none"> • The frying tray is overloaded. 	<ul style="list-style-type: none"> • Soak, rinse and fully dry potatoes before frying. • Use fresh, firm potatoes.
Fries are not crispy	<ul style="list-style-type: none"> • Raw fries have too much water. 	<ul style="list-style-type: none"> • Use a clean kitchen towel to wrap and dry cut potato fries thoroughly before adding oil. • Cut potato fries into smaller slices. • Shake and spray potato fries frequently.

ERROR CODES

ERROR	WHY	SOLUTION
E-1	Open circuit of the air fryer sensor.	Turn OFF the power, open the oven door and wait for 8-10 minutes, then restart.
E-2	The air fryer sensor has short circuited.	
E-3	The air fryer sensor is overheated.	Please contact Customer Service for help.
E-4	Power board error.	
E-5	Open circuit of the steam generator sensor.	
E-6	Short circuit of the steam generator sensor.	

SPECIFICATION

- Model No: DH171
- Accessories: Grill Rack, Baking Tray, Pizza Tray
- Capacity: 15L Oven 700ml Water Tank
- Maximum Timer Settings: 60 Minutes
- Power: Fryer - 1635W, Steamer - 985W
- Product Dimensions (W x D x H): 375 x 350 x 400mm
- Supply: 230v ~ 50Hz
- Temperature Range: 40-200°C



Environment Protection, Waste Electrical and Waste Electronic Equipment Regulations (WEEE)



Recycle unwanted packaging materials. When this product is no longer required, or has reached the end of its useful life, please dispose of in an environmentally friendly way. Drain any fluids (if applicable) into approved containers, in accordance with local waste regulations.



Please note that this product contains one or more batteries. It is our policy to continually improve products and we reserve the right to alter data, specifications and parts without prior notice. No liability is accepted for incorrect use of this product. Guarantee is 12 months from purchase date, proof of which is required for any claim.



Dellonda Limited, Sole UK Distributor of Baridi

Kempson Way, Suffolk Business Park, Bury St Edmunds, Suffolk. IP32 7AR



01284 757575



support@dellonda.co.uk



www.dellonda.co.uk