

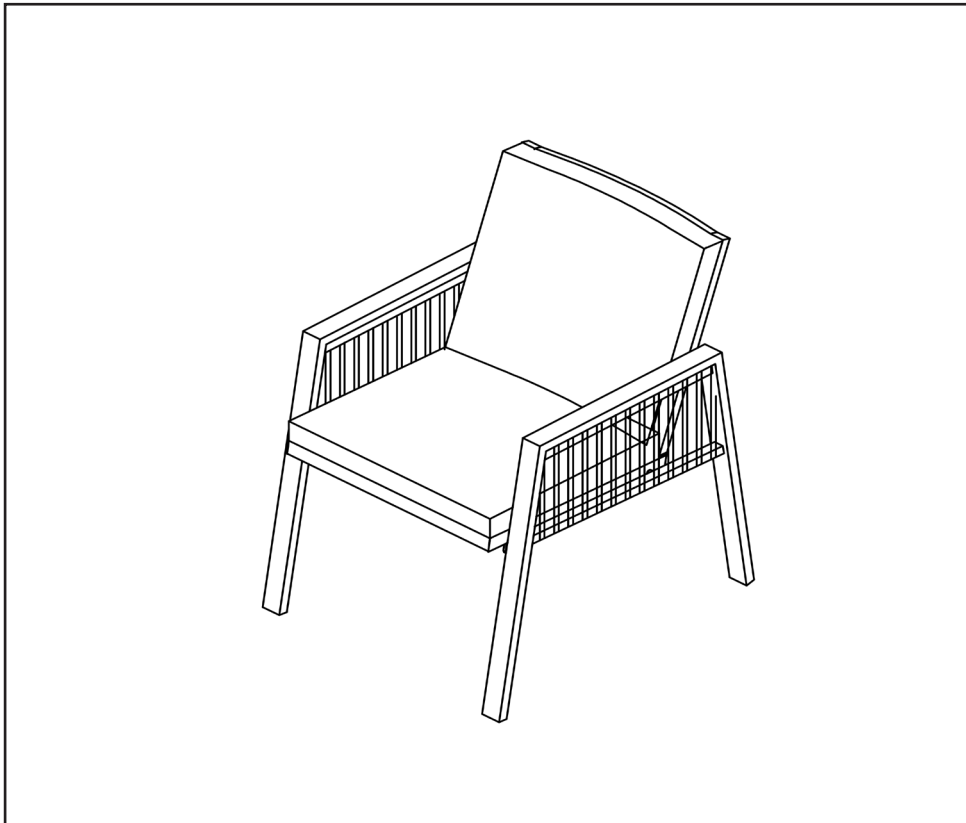

Fusion Garden/Patio Dining Chair with Armrests - Set of 4



Model No. DG50

Thank you for purchasing a Dellonda product. Manufactured to a high standard, this product will, if used according to these instructions, and properly maintained, give you years of trouble free performance.

Important Information

Please read these instructions carefully. Note the safe operational requirements, warnings & cautions. Use the product correctly and with care for the purpose for which it is intended. Failure to do so may cause damage and/or personal injury and will invalidate the warranty. Keep these instructions safe for future use.



Refer to
instruction
manual



Wear gloves
during
assembly

Specification

Model No.: DG50

Dimensions (W x D x H).....690 x 560 x 850mm

About the Product

Manufactured using powder coated rust proof aluminium. Contemporary design with 8mm round weather proof textilene® rope. Supplied with 5cm thick seat and back cushions.

Safety Instructions

- **GENERAL SAFETY**
- **WARNING!** The warnings, cautions and instructions in this manual cannot cover all possible conditions and situations that may occur. It must be understood by the operator that common sense and caution are factors which cannot be built into this product, but must be applied by the operator.
- Ensure the item is assembled properly and securely.
- To avoid tipping, use on firm, level ground.
- **DO NOT** expose to high temperature heat sources i.e. barbecue.
- **DO NOT** stand on furniture.

Assembly

- **CAUTION** It is inherent with fabricated steel parts that edges and corners can cause cuts if improperly handled during assembly. BE CAREFUL and wear correct work gloves.

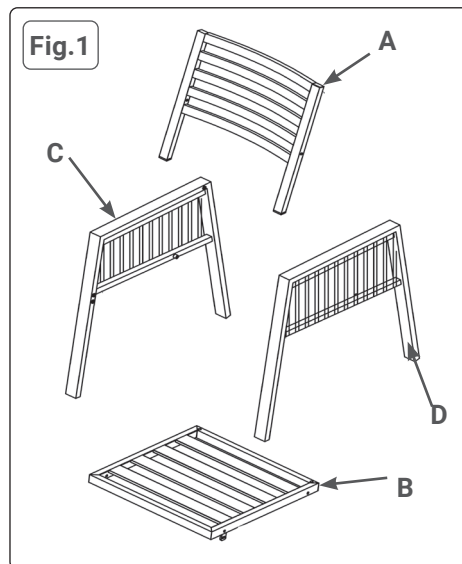
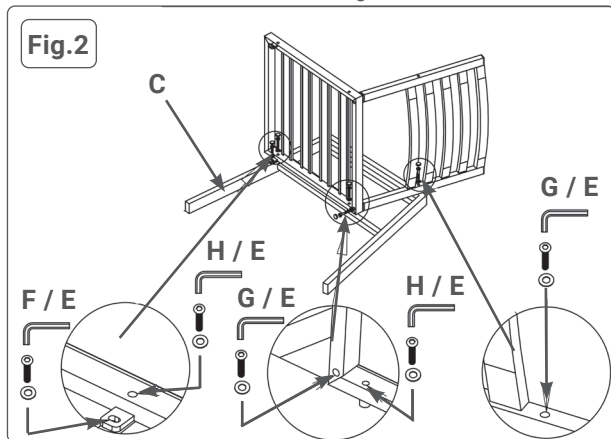

Part Number	Images and Sizes	Qty.
A		1
B		1
C		1
D		1
E	 M6*ø16	10
F	 M6*25	2
G	 M6*40	4
H	 M6*30	4

Maintenance

- Perform Maintenance at least once a year in order to extend the life of your furniture.
- Regularly check all fixings are secure
- Any modifications of this appliance may be dangerous and are not permitted. **DO NOT** alter parts supplied by the manufacturer.

Cleaning

- Regularly wipe down the chair frame with hot soapy water.

Storage

- We recommend you use a cover to protect this item when not in use. Covers must be removed periodically to minimise moisture build up.

Environment Protection and Waste Protection and Electrical Equipment Regulations (WEEE)

Recycle unwanted packaging materials. When this product is no longer required, or has reached the end of its useful life, please dispose of it in an environmentally friendly way. It is our policy to continually improve products and we reserve the right to alter data, specifications and parts without prior notice. No liability is accepted for incorrect use of this product. Guarantee is 12 months from purchase date, proof of which is required for any claim.

Dellonda Limited

Kempson Way, Suffolk Business Park, Bury St Edmunds, Suffolk. IP32 7AR

01284 757575

support@dellonda.co.uk

www.dellonda.co.uk