



CAR PORT SHELTER 3.3 X 7.5 X 2.9M

MODEL NO: **CPS02**

Thank you for purchasing a Sealey product. Manufactured to a high standard, this product will, if used according to these instructions, and properly maintained, give you years of trouble free performance.

IMPORTANT: PLEASE READ THESE INSTRUCTIONS CAREFULLY. NOTE THE SAFE OPERATIONAL REQUIREMENTS, WARNINGS & CAUTIONS. USE THE PRODUCT CORRECTLY AND WITH CARE FOR THE PURPOSE FOR WHICH IT IS INTENDED. FAILURE TO DO SO MAY CAUSE DAMAGE AND/OR PERSONAL INJURY AND WILL INVALIDATE THE WARRANTY. KEEP THESE INSTRUCTIONS SAFE FOR FUTURE USE.



Refer to instruction manual



Wear eye protection



Wear protective gloves

1. SAFETY

- ✗ This is a temporary structure and is not recommended as a permanent structure.
- ✓ Choose your shelter's location carefully. Check for overhead utility lines, branches, etc. **DO NOT** install near rooves or other structures that may shed snow, ice or excessive run-off onto your shelter. Keep away from electrical wires!
- ✓ Have an overview of all parts before attempting installation. Make sure all components are available.
- ✗ **DO NOT** use this product in environments for which it is not intended (i.e. extreme cold, high winds, extreme heat, heavy rainfall, etc).
- ✓ Always wear safety glasses when assembling this product. Wear gloves when working with tubing to prevent cuts or abrasions.
- ☐ **WARNING!** Anchors must be used with all shelters. Covers should **NOT** be installed until it has been properly anchored to the ground.
- ✓ Proper anchoring and keeping cover tight and free of snow and debris, is the responsibility of the consumer. Damages caused by improper anchoring are not covered under warranty.
- ☐ **WARNING!** Keep all flame and heat sources away from the shelter fabric. The fabric will burn if left in continuous contact with a flame source.
- ✗ **DO NOT** use open flames or cooking or heating devices inside or in close proximity to the product, including all types of stoves, gas heaters, gas lanterns, citronella torches, mosquito coils, etc.
- ☐ **WARNING!** In order to reduce risk of burning and avoid damage, **DO NOT**- cook, smoke, refuel or use any open flame devices in or around the shelter.- store flammable liquids (gasoline, kerosene, propane, etc.) in the shelter.- operate gas powered equipment in or around the shelter.
- ✓ Keep open flames a safe distance away from the shelter.
- ✗ **DO NOT** use hard-edged tools or instruments, such as rakes or shovels, to remove snow. These can cause punctures to the cover.
- ✗ **NEVER** start the engine of any vehicle or machine inside a closed shelter. Ensure that there is adequate ventilation for starting engines and for any work with paints, cleaners, etc.
- ✗ **DO NOT** use bleach, alkaline or harsh detergents for cleaning. Doing so will damage the polycarbonate material. Soap and warm water are recommended.
- ✓ This temporary shelter is intended to offer protection from damages caused by the sun, light rain, light snow, tree sap, bird and animal excrement. **DO NOT** use it to shield goods from high winds, heavy snow or ice storms. Only use it for its intended use.
- ✗ **DO NOT** assemble in high winds.

2. INTRODUCTION

Allows for extra space quickly, a garage for cars/small commercial vehicles, storage for boats, materials and machinery. Constructed of corrosion resistant powder coated high quality steel frame work and a heavy-duty tarpaulin made of a PE (polyethylene) material which is UV resistant making for a durable and long lasting shelter. Included stake pegs secure the shelter, a dirt skirt on both sides further protects against crosswinds. A wide opening zip door which can be rolled up out of the way, provides easy-access. This item is heavy. Extra assistance must be provided at the delivery point to help its safe delivery.

3. SPECIFICATION











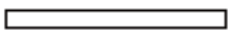

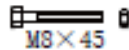

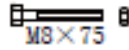
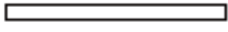
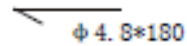
Model No:.....CPS02
 Overall Size: (W xD x H)3.3 x 7.5 x 2.9M

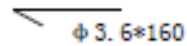
4. ASSEMBLY

4.1. Assembly Preparation.

- 4.1.1. Place all parts from the packaging box in a cleared area and arrange them on the ground in front of you.
- 4.1.2. Remove all packaging materials and place them back in the box. **DO NOT** dispose of the packaging materials until assembly is complete. Check for completeness and transport damages, refer to figs.1 and 2.
 - ☐ **WARNING! DO NOT** place the product under trees from which hard fruit such as apples, walnuts or heavy pine cones, etc., may fall.
- 4.1.3. Keep children away during assembly. This product contains small parts which can be swallowed by children.
- 4.1.4. **DO NOT** attempt to assemble the product if any parts are missing.
- 4.1.5. At least 3 people are needed to complete the assembly as some of the steps require heavy lifting.
 - ☐ **WARNING! DO NOT** leave the shelter unattended during assembly. Otherwise, personal injury or damage to the shelter may occur!

fig.1

1#		10pcs			80pcs
2#		12pcs	E		16pcs
3#		10pcs	F		10pcs
4#		8pcs			20pcs
		9pcs			24pcs
		6pcs			1pc
		12pcs			1pc
		8pcs			1pc
		10pcs			8pcs

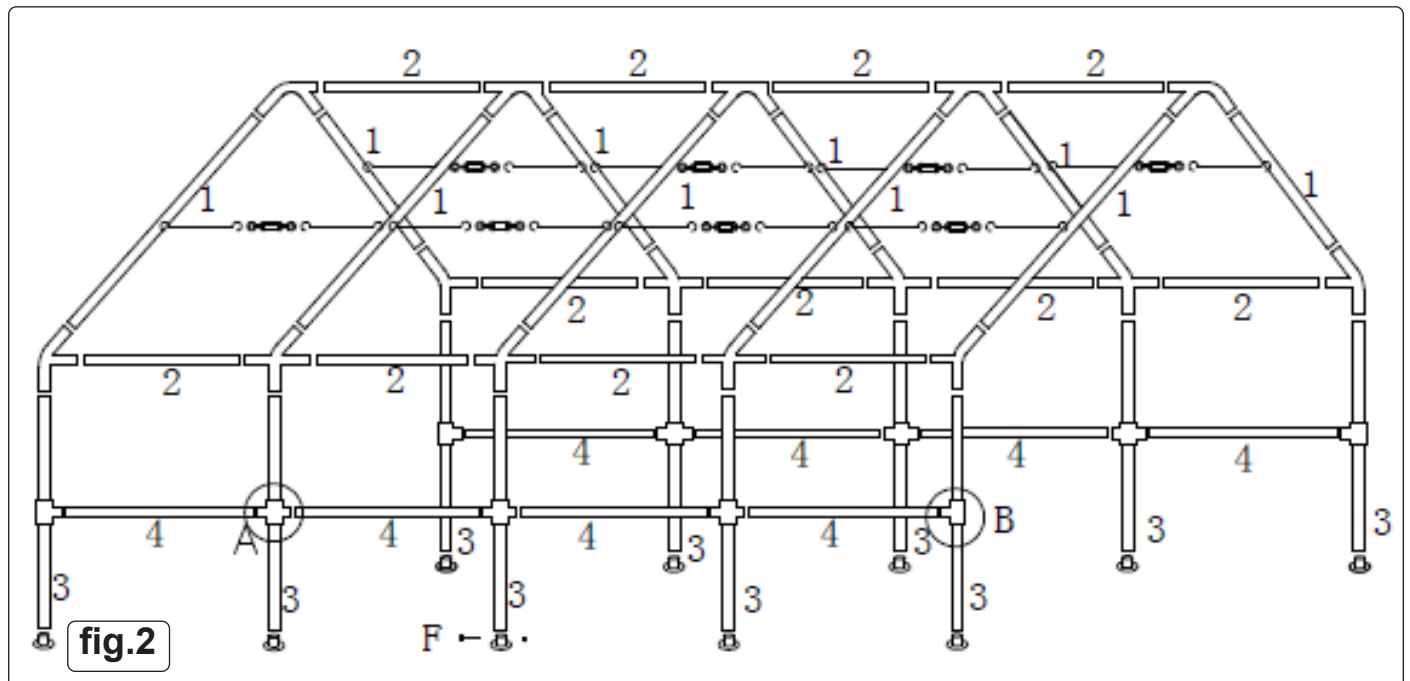

4.2. Assemble Roof Frame.

4.2.1. Using fig.2 as a guide assemble the roof frame.

4.2.2. Fit the eight roof strainers and tension them.

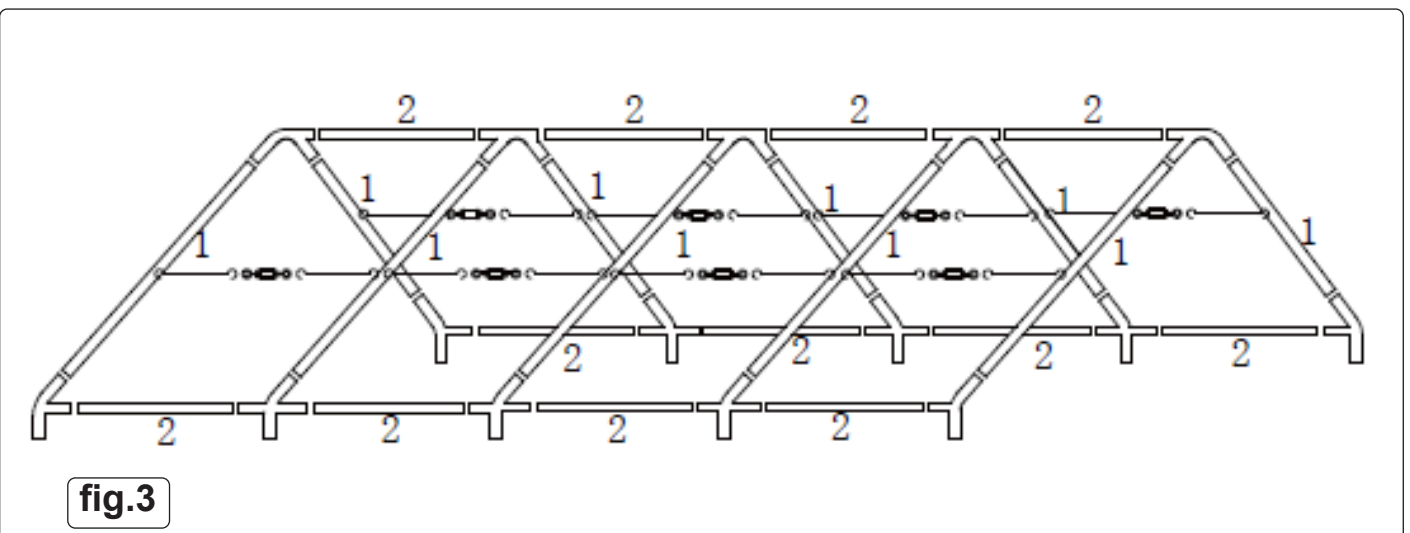

4.3. Fit Cover (Roof and Sides).

4.3.1. Pull the cover over the roof frame, make sure the cover fits properly at the eaves and at the edge of the roof.

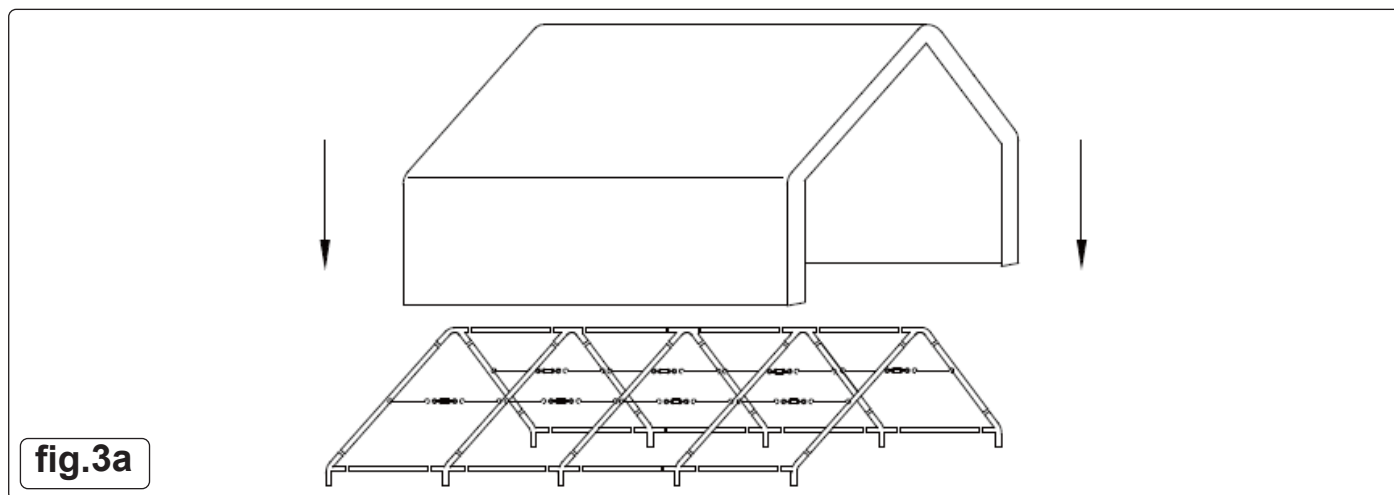

4.4. Fit Legs and Cross Braces.

4.4.1. Ensure that there are enough people to lift the weight of the roof and cover.

4.4.2. Lift the roof and cover high enough to insert the legs first down one side, then repeat for the other.

4.4.3. Pass the cross braces through the sleeves then refer to figs. 4 and 5 for the assembly of the middle leg brackets and figs. 6 and 7 and for the assembly of the end leg brackets.

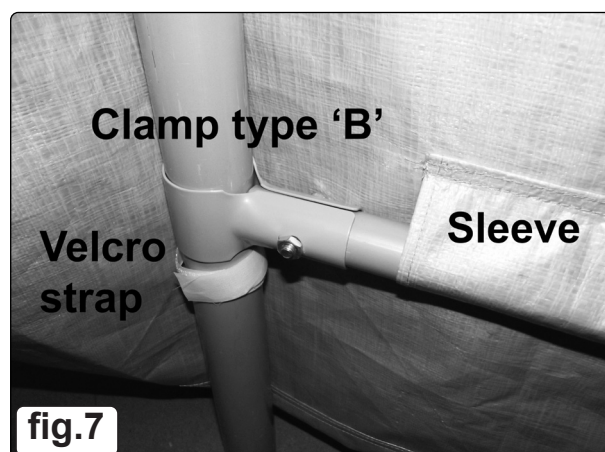
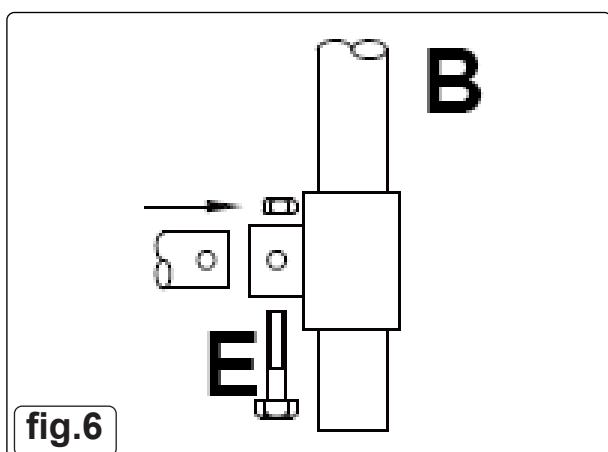
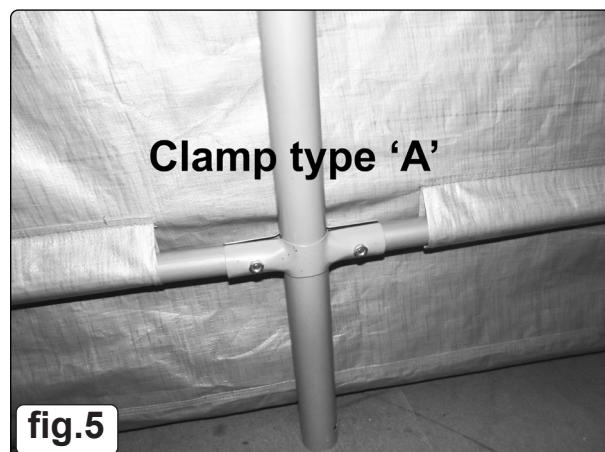
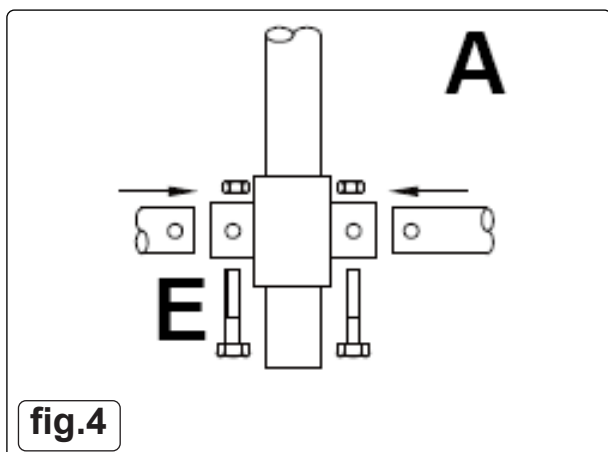

4.5. Fix Cover and Fit Ends.

4.5.1. Fix the cover to the frame by closing the velcro strips round the poles. Then fit the toggles through the eyelets and round the frame, see fig.8.

4.5.2. Use a ladder to fit the ends using toggles.

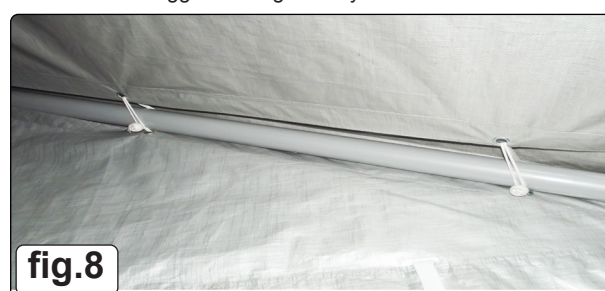

4.6. **Fix Feet.**

4.6.1. Bolt the feet on see fig.9 and use the pegs to secure the shelter to the ground, see fig.10.

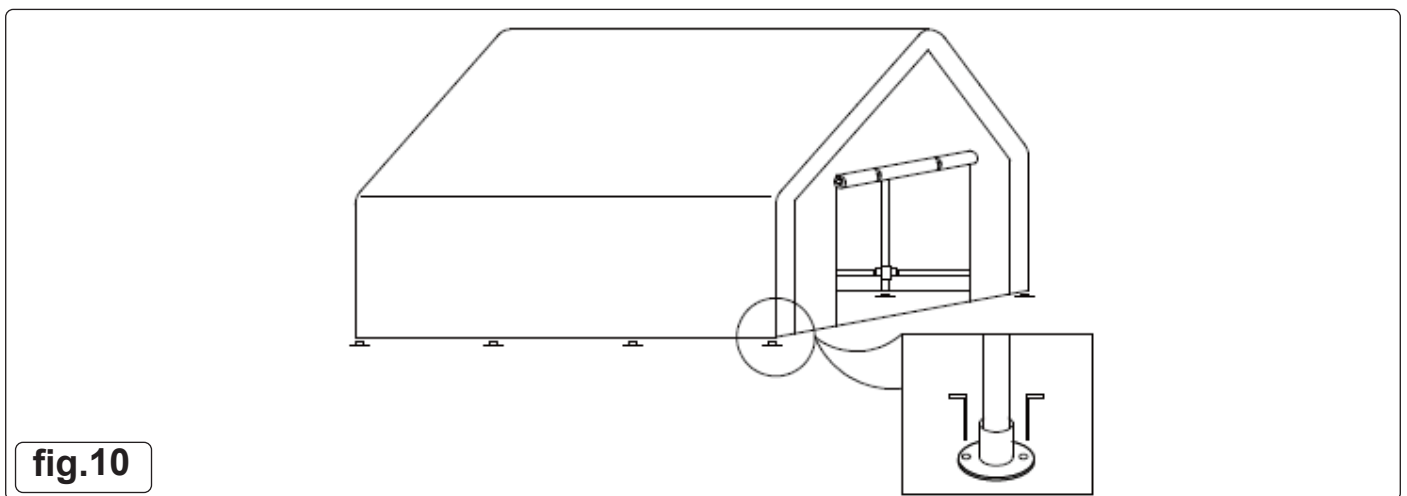
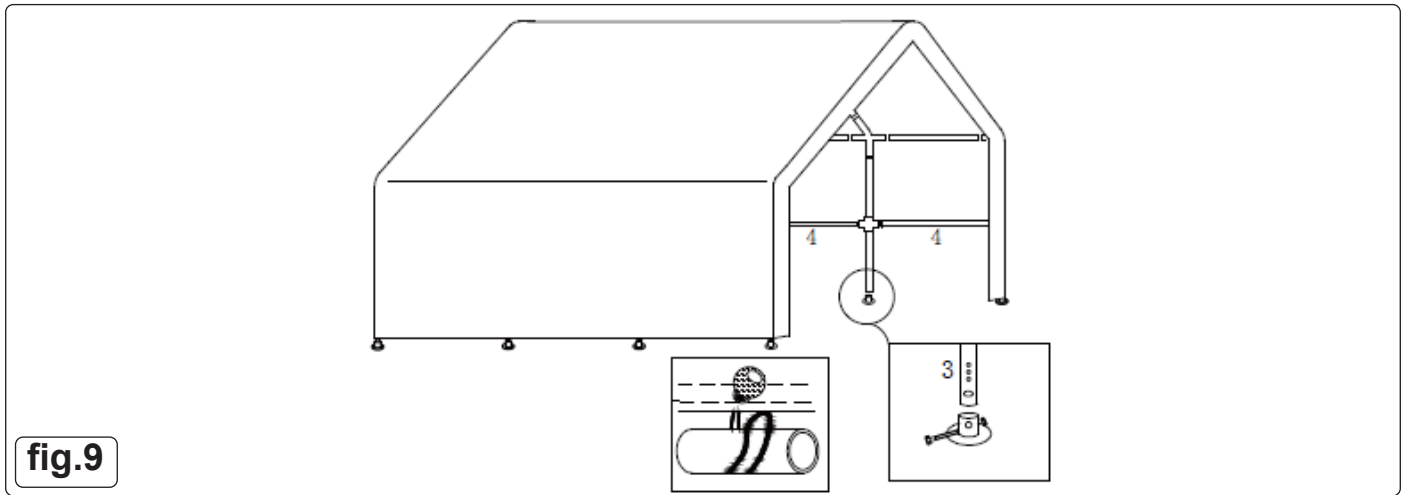

ENVIRONMENT PROTECTION

Recycle unwanted materials instead of disposing of them as waste. All tools, accessories and packaging should be sorted, taken to a recycling centre and disposed of in a manner which is compatible with the environment. When the product becomes completely unserviceable and requires disposal, drain any fluids (if applicable) into approved containers and dispose of the product and fluids according to local regulations.

Note: It is our policy to continually improve products and as such we reserve the right to alter data, specifications and component parts without prior notice.

Important: No Liability is accepted for incorrect use of this product.

Warranty: Guarantee is 12 months from purchase date, proof of which is required for any claim.



REGISTER YOUR PURCHASE HERE

Sealey Group, Kempson Way, Suffolk Business Park, Bury St Edmunds, Suffolk. IP32 7AR



01284 757500



01284 703534



sales@sealey.co.uk



www.sealey.co.uk