



20V 15L CORDLESS GARDEN BACKPACK SPRAYER - BODY ONLY

MODEL NO: CP20VGBS

Thank you for purchasing a Sealey product. Manufactured to a high standard, this product will, if used according to these instructions, and properly maintained, give you years of trouble free performance.

IMPORTANT: PLEASE READ THESE INSTRUCTIONS CAREFULLY. NOTE THE SAFE OPERATIONAL REQUIREMENTS, WARNINGS & CAUTIONS. USE THE PRODUCT CORRECTLY AND WITH CARE FOR THE PURPOSE FOR WHICH IT IS INTENDED. FAILURE TO DO SO MAY CAUSE DAMAGE AND/OR PERSONAL INJURY AND WILL INVALIDATE THE WARRANTY. KEEP THESE INSTRUCTIONS SAFE FOR FUTURE USE.



Refer to instructions



Wear eye protection



Wear protective gloves



Wear protective clothing



Wear a mask



Wear respiratory protection

1. SAFETY

- ✓ Only use the sprayer for its intended purpose.
- ✓ Familiarise yourself with the applications, limitations and potential hazards of this product.
- ✓ Replace or repair damaged parts. Use recommended parts only. Unauthorised parts may be dangerous and will invalidate the warranty.
- ✓ Always inspect and prepare the sprayer before use according to the instructions contained in this manual.
- ✗ **DO NOT** use the sprayer if it is damaged, altered, modified, in poor condition, leaking fluids or has any missing components.
- ✗ **DO NOT** alter the sprayer in any way.
- ✗ **DO NOT** use the sprayer for spraying flammable materials.
- ☐ **WARNING!** Ensure you are fully aware of all the potential hazards of the material being sprayed. Read and understand the warnings and instructions on the container or the supplied manufacturers information.
- ✗ **DO NOT** spray any material where the hazards are not known.
- ✓ Ensure that the spray containers cannot easily be knocked over during filling.
- ✓ Mark fluid containers with hazard labels to show its chemical contents, even if it's water.
- ✓ It is highly recommended that individual fluid containers should be used only for one type of specific agent.
- ✓ Keep any fluid containers in a well ventilated, lockable store.
- ✓ Keep children and unauthorised persons away from the working area, especially during the spraying operation.
- ✓ Maintain the sprayer in good condition and keep clean to maintain safest performance.
- ✓ Ensure that the fluid containers cannot easily be knocked over when transferring unused fluid back into it.
- ✓ Keep the sprayer turned off.
- ✓ Keep the fluid tank lid firmly closed to prevent any spillage.
- ✗ **DO NOT** turn on the power until ready to spray.
- ✓ Be aware of wind direction whilst spraying. Spray from upwind to downwind to prevent direct chemical contact with your body.
- ✗ **DO NOT** spray when the wind speed is in excess of 4mph.
- ✗ **DO NOT** over apply pesticide. Only apply at the manufacturer's recommended rate. Excess pesticide can be hazardous to humans, wild life, damage plants and contaminate soil and water sources.
- ✗ **DO NOT** eat, drink, rub your eyes, or touch any part of your bare skin whilst handling fluids or when spraying. If chemical(s) come into contact with skin, immediately wash thoroughly with soap and water.
- ✗ **DO NOT** spray near open flames or other sources of heat.
- ✗ **DO NOT** smoke or use an open flame anywhere near the sprayer or around stored fluids.
- ✓ Maintain correct balance and footing. Ensure the floor is not slippery and wear non-slip shoes.
- ✗ **DO NOT** operate the sprayer when you are tired or under the influence of alcohol, drugs or intoxicating medication.
- ✓ Always clean up any spills immediately as per fluid manufacturers instructions.
- ✗ **DO NOT** spray at people, animals or protected insect species.
- ✓ Select the appropriate chemical which offers the best solution to your pest or weed problem.
- ☐ **WARNING!** When mixing chemicals, thoroughly read and understand the manufacturers instructions.
- ☐ **WARNING!** Inappropriately mixed chemicals may harm people and damage crops or plants.
- ✓ Always mix chemicals prior to adding the solution to the sprayers tank reservoir.
- ✓ Ensure the sprayers tank reservoir is full prior to use. Operating the sprayer with an empty tank may damage the pump.
- ☐ **WARNING!** If the spraying stops running, or an abnormal sound is emitted immediately switch off and remove the battery.
- ☐ **WARNING!** Wear appropriate PPE (Personal Protective Equipment). To avoid inhalation and/or skin or eye contact with the chemical wear, protective goggles, protective mask, rubber gloves, long sleeved waterproof jacket, long trousers and Wellington boots.
- ☐ **WARNING!** Remove battery cartridge when performing maintenance or making adjustments.
- ✓ Operators, whose physical, sensory or mental capabilities prevents them from safely using the sprayer, must be under the supervision of a person who has a thorough knowledge and experience of the sprayer and the appropriate regulations.
- ✗ **DO NOT** allow children or untrained persons to operate the sprayer.
- ☐ **WARNING!** The warnings, cautions and instructions discussed in this instruction manual cannot cover all possible conditions and situations that may occur. It must be understood that common sense and caution are factors which cannot be built into this product, but must be applied by the operator.

2. INTRODUCTION

Cordless 20V backpack garden sprayer. This sprayer does not require manual pressing which makes it easy and practical to use. Supplied with 3 different nozzles to meet different needs and an auto cut-off function. This backpack sprayer can be used for sterilization, disinfection, weed killing as well as watering flowers and spraying water. It has an added filter to prevent larger particles clogging the machine. With strong durable back straps to ensure comfort when worn. 15L water tank with a lance holder clip. Spraying lance including hose is 2.53m. Requires compatible 20V battery and mains charger, sold separately.

3. SPECIFICATION

Model No: CP20VGBS
 Consumable parts:
 Battery (not included):
 2Ah CP20VBP2
 4Ah CP20VBP4
 6Ah CP20VBP6
 Mains Charger (not included): CP20VMC
 Dimensions (W x D x H): 315mm x 320mm x 580 mm
 Hose length: 1.7m
 Maximum flow rate: 1.3L/min
 Maximum pressure: 1.6bar
 Noise power: 83dB(A)
 Noise pressure: 72dB(A)
 Tank capacity: 15L
 Vibration: 0.494m/s²
 Vibration uncertainty: 1.5m/s²

4. CONTENTS

ITEM	DESCRIPTION
1	Nozzle
2	Spray pipe
3	Fluid tank lid
4	Spray pipe holder
5	Fluid tank reservoir
6	Trigger lever
7	Control handle
8	Water pipe
9	Power switch
10	Battery cartridge cover
11	Bolt
12	Back pad
13	Back strap
14	Nozzle selection

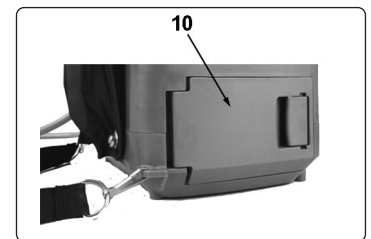
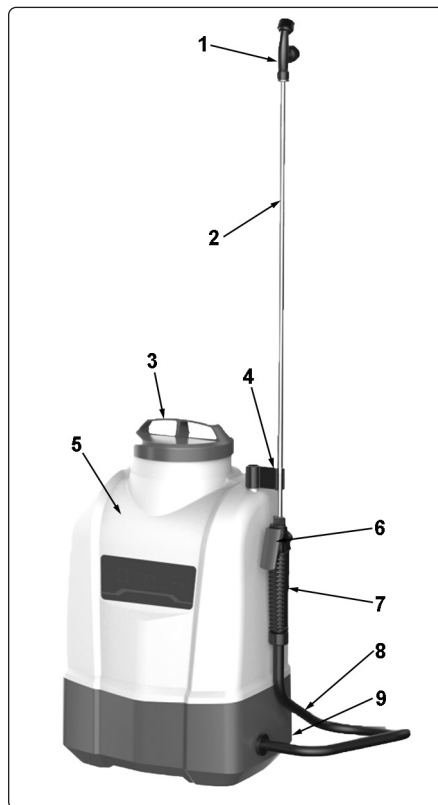

5. ASSEMBLY

5.1. INSTALLING THE BATTERY CARTRIDGE

- 5.1.1. Open the battery cover door by releasing the sprung catch (fig 1).
- 5.1.2. Align the tongue on the battery cartridge with the groove in the battery housing and slide into place.
- 5.1.3. Insert all the way until the battery cartridge is locked into position with an audible click.
 - × **DO NOT** try and insert the battery cartridge forcibly.
- 5.1.4. Firmly close the battery cover (fig 3).

5.2. REMOVING THE BATTERY CARTRIDGE

- 5.2.1. Open the battery cover door by releasing the sprung catch (fig 1).
- 5.2.2. Push the battery cartridge latch button, then slide and remove the battery (fig 2).
- 5.2.3. Firmly close the battery cover (fig 3).

- **WARNING!** Ensure that the sprayer is switched off and the battery cartridge is removed prior to undertaking any work on the sprayer.

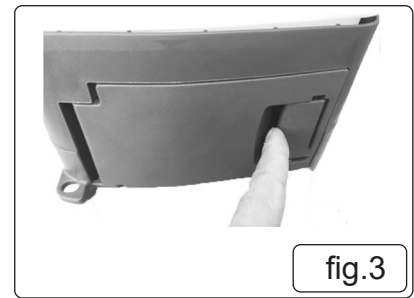
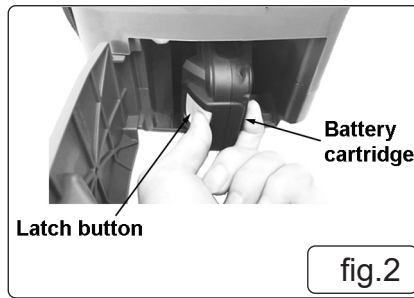
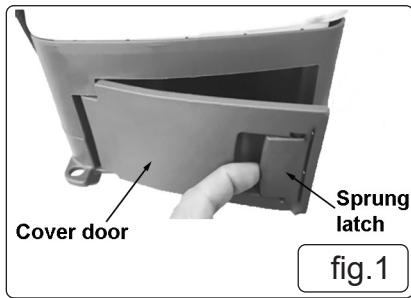

5.3. CONNECTING THE WATER PIPE

- **WARNING!** Ensure the supplied joint washers are fitted, check prior to assembly.
NOTE: Securely attach the water pipe to ensure that there are no leaks.

- 5.3.1. Insert the end of the water pipe centrally into the opening of the control handle (fig 4).
- 5.3.2. Firmly push the hose as far as it will go (fig 4).
- 5.3.3. Slide the fixing nut down the hose and onto the threaded end of the control handle.
- 5.3.4. Fully tighten by turning the fixing nut clockwise (fig 5).

5.4. DISCONNECTING THE WATER PIPE

- 5.4.1. To disconnect the water pipe follow section 5.3 but in reverse.

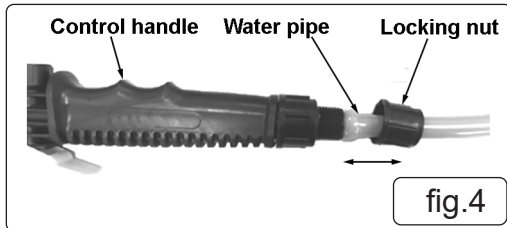

5.5. CONNECTING THE SPRAY PIPE

- **WARNING!** Ensure the supplied joint washers are fitted, check prior to assembly.
NOTE: Securely attach the spray pipe to ensure that there are no leaks.

- 5.5.1. Locate the end of the spray pipe centrally onto the remaining threaded end of the control handle (fig 6).
- 5.5.2. Fully tighten by turning the end nut clockwise (fig 7).

5.6. DISCONNECTING THE SPRAY PIPE

- 5.6.1. To disconnect the spray pipe follow section 5.5 but in reverse.

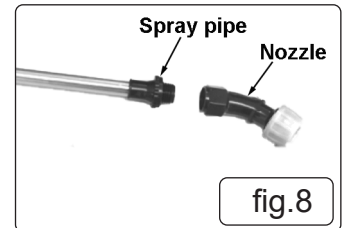
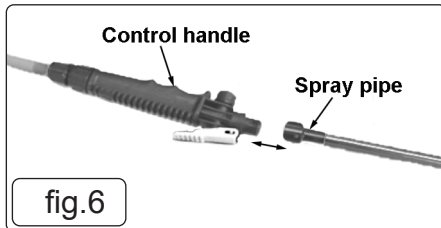

5.7. CONNECTING THE NOZZLE

- 5.7.1. Select nozzle type to suit application.
- 5.7.2. Locate the end of the nozzle centrally onto the threaded end of the spray pipe (fig 8).
- 5.7.3. Fully tighten by turning the end nut clockwise (fig 8).

5.8. DISCONNECTING THE NOZZLE

- 5.8.1. To disconnect the nozzle follow section 5.7 but in reverse.

5.9. REMOVAL OF BACK PAD

- 5.9.1. Unscrew the four fixing bolts with a T30 star head screw bit and place in a secure location (fig 9).
- 5.9.2. Remove the back pad and place in a dry, secure location.

5.10. ATTACHING THE BACK PAD

- 5.10.1. To attach the back pad follow section 5.9 but in reverse.
- 5.10.2. Fully tighten the fixing bolts.

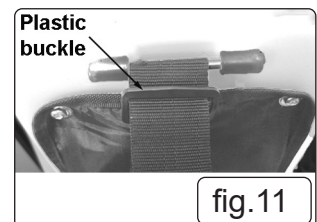
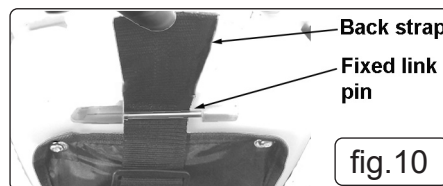
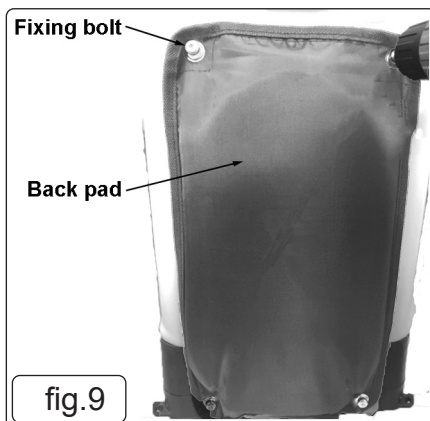

5.11. ATTACHING THE BACK STRAP

5.11.1. Feed the back strap through the fixed link pin (fig 10).

5.11.2. Feed the back strap through the upper slot of the plastic buckle (fig 11), and then through the lower slot of the plastic buckle and pull tight (fig 12).

5.12. ATTACHING THE BOTTOM CLIP

5.12.1. Hook each bottom clip onto its corresponding tab at the base of the sprayer (fig 13).

5.13. BACK STRAP ADJUSTMENT

✓ Adjust the back strap so that the sprayer is in a comfortable position and as close as possible to the body.

5.13.1. To lengthen the strap, lift up the buckle (fig 14), and pull the belt through from the side connected to the sprayer.

5.13.2. To shorten the strap, lift up the buckle (fig 14), and pull the belt through on the free side.

☐ **WARNING!** Ensure that the back strap is securely attached to the sprayer.

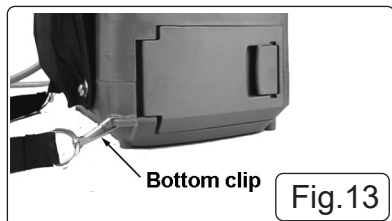

Fig.13

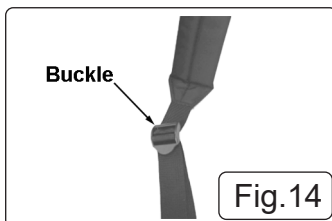

Fig.14

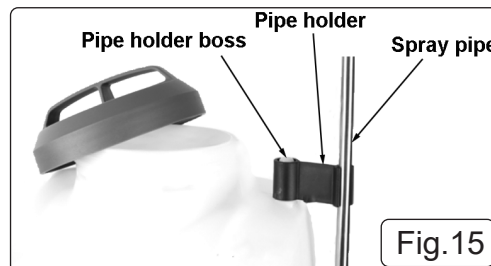

Fig.15

5.14. ATTACHING THE SPRAY PIPE HOLDER

5.14.1. Fully slide the pipe holder over the pipe holder boss (fig 15).

5.14.2. Insert the spray pipe into the pipe holder (fig 15).

5.14.3. To remove the pipe holder lift it up and off the pipe holder boss and place in a secure location.

6. OPERATION

NOTE: Ensure all Safety Instructions in Section 1 are read and understood and carried out before use and save the instructions and warnings for future reference.

6.1. POWER SWITCH

☐ **WARNING!** Ensure that the sprayer power switch is in the OFF position prior to installing the battery cartridge.

☐ **WARNING!** To prevent sudden spraying ensure that the trigger lever is in the stop position and the power switch is in the OFF position.

6.1.1. To turn the sprayer on, press down the I (ON) on the power switch (fig 16).

6.1.2. To turn the sprayer off, press down the O (OFF) on the power switch (fig 16).

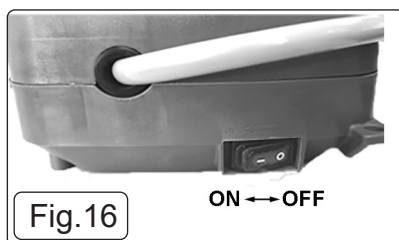

Fig.16

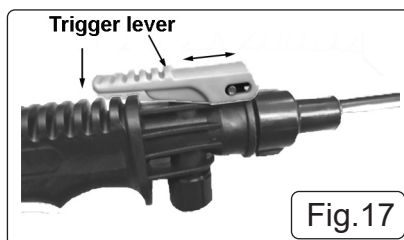

Fig.17

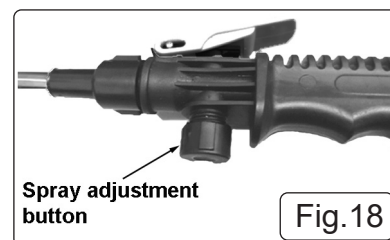

Fig.18

6.2. OPERATING THE SPRAYER

6.2.1. To operate the sprayer depress the trigger lever to spray, then release the trigger lever to stop (fig 17).

6.2.2. For continuous spraying depress the trigger lever and while it's depressed push forward to lock on.

6.2.3. To lock off pull the trigger lever back and release (fig 17).

6.3. SPRAYING

6.3.1. When using the sprayer firmly grip the control handle.

6.3.2. Once spraying is complete release the trigger lever to stop and turn the power switch to OFF.

6.4. SPRAY ADJUSTMENT

6.4.1. To adjust the intensity of the spraying turn the adjustment button clockwise to increase and anticlockwise to decrease (fig 18).

× **DO NOT** operate the sprayer with an empty tank. Turn OFF immediately.

× **DO NOT** use the sprayer with the battery cover open or with the back pad removed.

☐ **WARNING!** Prolonged continuous use of the sprayer will drain the battery and may cause damage to the pump. Switch OFF the sprayer whenever possible.

☐ **WARNING!** If the sprayer starts to make abnormal noises and/or the spray splutters this indicates that the tank is empty. Switch OFF immediately.

6.5. FILLING THE TANK

☐ **WARNING!** Ensure that the sprayer power switch is in the OFF position prior to filling the tank.

6.5.1. When filling the tank ensure the tank filter is fitted into the top of the tank (fig 23).

6.5.2. Fill the tank with the required volume utilising the level indicators on the tank.

6.5.3. Firmly tighten the tank lid after filling.

NOTE: Maximum volume of tank = 15L.

☐ **WARNING!** When filling the tank wear appropriate PPE.

☐ **WARNING! DO NOT** fill tank in a poorly ventilated area.

7. MIXING CHEMICALS

☐ **WARNING!** Ensure that all chemical mixtures are thoroughly dissolved prior to use.

☐ **WARNING!** Take extreme care when handling chemicals. Wear appropriate PPE. Wash thoroughly away any chemicals that comes into contact with bare skin.

☐ **WARNING!** Chemicals are harmful. Always read and fully understand the manufacturers instructions before use.

8. MAINTENANCE

- 8.1. Have the sprayer serviced by a qualified repair person using only genuine replacement parts. This will ensure that the safety of the sprayer is maintained.
- × **DO NOT** attempt any maintenance or repairs that are not included in this manual.
 - × **DO NOT** use solvents to clean sprayer.
- 8.2. **AFTER USE MAINTENANCE**
- 8.2.1. Dispose of any residual liquid from the sprayer tank, by returning it back to its original container. Clean up any spills immediately as per fluid manufactures instructions.
- 8.2.2. Wash out the tank with clean water and after cleaning, pour the water into a suitable container.
- 8.2.3. Refill the tank with clean water and run the sprayer for up to 3 minutes, removing any residue from the pump, water hose, control handle, spray pipe and nozzle into a suitable container. Ensure all water has been removed from the system.
- 8.2.4. Wipe away any remaining moisture with a dry cloth.
- NOTE:** Dispose of any contaminated water properly according to local regulations.
- 8.3. **WATER ABSORPTION STRAINER CLEANING**
- **WARNING!** Ensure that the tank has been washed out and is free from any chemicals.
- 8.3.1. Unscrew and remove the tank lid and then the tank strainer.
- NOTE:** The water absorption strainer is located at the bottom of the tank.
- 8.3.2. Locate the water absorption strainer (fig 18) and carefully remove the strainer from the water pipe (fig 19).
- 8.3.3. Remove the top cap and clear any debris from the inside of the strainer (fig 20).
- 8.3.4. Replace the top cap and reattach the strainer to the water hose.
- 8.3.5. Refit the tank strainer and then the tank lid.
- NOTE:** The water absorption strainer prevents debris from entering the pump. Periodically clean the water absorption strainer to maintain optimal performance.

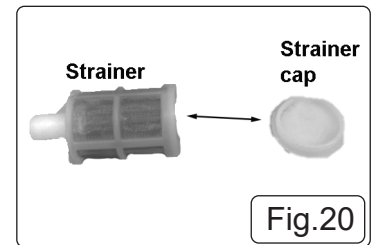
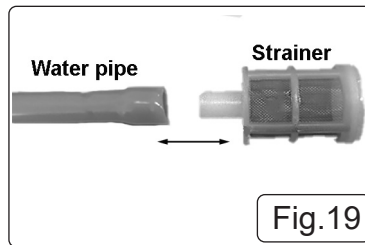
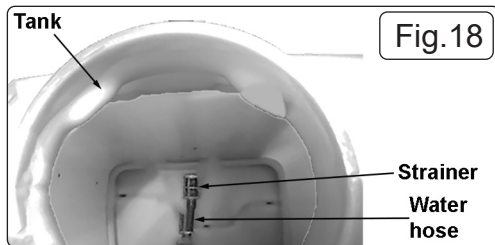

- 8.4. **CONTROL HANDLE STRAINER CLEANING**
- 8.4.1. Fully unscrew the nut on the control handle (fig 21) and detach the water pipe.
- 8.4.2. Remove the filter and remove any debris from the inside of the strainer (fig 22).
- 8.4.3. Replace the strainer and reattach the water pipe and fully tighten nut on the control handle.
- NOTE:** The control handle prevents debris from entering the spray hose. Periodically clean the control handle to maintain optimal performance.

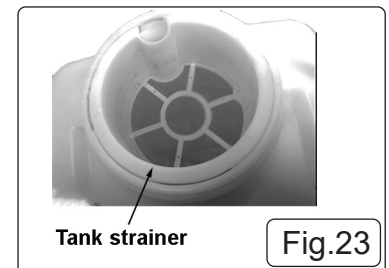
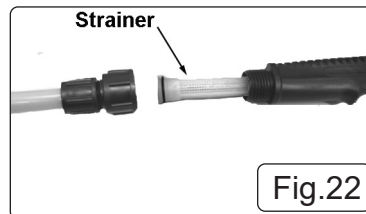
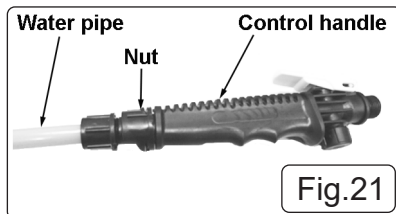

- 8.5. **TANK STRAINER CLEANING**
- 8.5.1. Unscrew and remove the tank lid.
- 8.5.2. Remove the tank strainer and clear any debris from the inside of the strainer (fig 23).
- 8.5.3. Refit the tank strainer and then the tank lid.
- 8.5.4. **NOTE:** The tank strainer prevents debris from entering the tank. Periodically clean the tank strainer to maintain optimal performance.

9. STORAGE

- 9.1. Wash out the sprayer as section 8.1 and ensure that the sprayer is completely free from moisture.
- 9.2. Store the sprayer in a child free, safe, clean, dry indoor location that is away from direct sunlight, has good ventilation and does not freeze.
- **WARNING!** Frozen liquids that remain in the sprayer may cause breakdown or damage to the pump during operation.

10. TROUBLESHOOTING

PROBLEM		POSSIBLE CAUSE	SOLUTION
Motor (pump) will not work	Switch set at OFF	The switch is set to OFF	Set switch to ON
	Switch set at ON	No battery charge	Recharge the battery cartridge. Replace the battery if recharging is ineffective
		Wiring connector is disconnected	Repair at authorised Sealey service centre
		Wiring break	Repair at authorised Sealey service centre
		ON-OFF switch broken	Repair at authorised Sealey service centre
		Motor (pump) not working	Repair at authorised Sealey service centre
		Blown fuse	Repair at authorised Sealey service centre
Pump is working but no spray is coming out	Blocked nozzle	Clean or replace	
	Chemical tank is empty	Refill with required liquid	
	Blocked vent hole on tank lid	Clean	
	Blocked piping	Repair at authorised Sealey service centre	
	Broken or cracked piping	Repair at authorised Sealey service centre	
	Disconnected or broken piping	Repair at authorised Sealey service centre	
	Blocked water absorption strainer	Remove and clean	
Spraying pressure is low	Blocked vent hole on tank lid	Clean	
	Blocked piping	Repair at authorised Sealey service centre	
	Broken or cracked piping	Repair at authorised Sealey service centre	
	Disconnected or broken piping	Repair at authorised Sealey service centre	
	Blocked water absorption strainer	Remove and clean	
	Blocked control handle strainer	Remove and clean	
	Abnormal pressure regulator	Repair at authorised Sealey service centre	
	Worn gear case	Repair at authorised Sealey service centre	
Abnormal sound when sprayer is switched ON	Broken pump drive coupling	Repair at authorised Sealey service centre	
	Blocked nozzle	Clean or replace	
Sprayer is switched OFF but a large volume of liquid escapes from nozzle	Trigger lever is at locked on position	Set trigger lever to the OFF position	

This tool may cause Hand Arm Vibration Syndrome if its use is not managed adequately.

This tool is subject to the vibration testing section of the Machinery Directive 2006/42/EC.
This tool is to be operated in accordance with these instructions.

Measured vibration emission value (a): 0.494m/s²

Uncertainty value (k): 1.5m/s²

Please note that the application of the tool to a sole specialist task may produce a different average vibration emission. We recommend that a specific evaluation of the vibration emission is conducted prior to commencing with a specialist task.

A health and safety assessment by the user (or employer) will need to be carried out to determine the suitable duration of use for each tool.

NB: Stated Vibration Emission values are type-test values and are intended to be typical.

Whilst in use, the actual value will vary considerably from and depend on many factors.

Such factors include; the operator, the task and the inserted tool or consumable.

NB: ensure that the length of leader hoses is sufficient to allow unrestricted use, as this also helps to reduce vibration.

The state of maintenance of the tool itself is also an important factor, a poorly maintained tool will also increase the risk of Hand Arm Vibration Syndrome.

Health surveillance.

We recommend a programme of health surveillance to detect early symptoms of vibration injury so that management procedures can be modified accordingly.

Personal protective equipment.

We are not aware of any personal protective equipment (PPE) that provides protection against vibration injury that may result from the uncontrolled use of this tool. We recommend a sufficient supply of clothing (including gloves) to enable the operator to remain warm and dry and maintain good blood circulation in fingers etc. Please note that the most effective protection is prevention, please refer to the Correct Use and Maintenance section in these instructions. Guidance relating to the management of hand arm vibration can be found on the HSC website www.hse.gov.uk - Hand-Arm Vibration at Work.



WEEE REGULATIONS

Dispose of this product at the end of its working life in compliance with the EU Directive on Waste Electrical and Electronic Equipment (WEEE). When the product is no longer required, it must be disposed of in an environmentally protective way. Contact your local solid waste authority for recycling information.



ENVIRONMENT PROTECTION

Recycle unwanted materials instead of disposing of them as waste. All tools, accessories and packaging should be sorted, taken to a recycling centre and disposed of in a manner which is compatible with the environment. When the product becomes completely unserviceable and requires disposal, drain any fluids (if applicable) into approved containers and dispose of the product and fluids according to local regulations.

Note: It is our policy to continually improve products and as such we reserve the right to alter data, specifications and component parts without prior notice.

Important: No Liability is accepted for incorrect use of this product.

Warranty: Guarantee is 12 months from purchase date, proof of which is required for any claim.

Sealey Group, Kempson Way, Suffolk Business Park, Bury St Edmunds, Suffolk. IP32 7AR



01284 757500



01284 703534



sales@sealey.co.uk



www.sealey.co.uk