



INSTRUCTIONS FOR: 18V CORDLESS HAMMER DRILLS

Models: **CP9918VHK & CP2018VHK.V2**

Thank you for purchasing a Sealey product. Manufactured to a high standard this article will, if used according to these instructions and properly maintained, give you years of trouble free performance.



IMPORTANT: PLEASE READ THESE INSTRUCTIONS CAREFULLY. NOTE THE SAFE OPERATIONAL REQUIREMENTS, WARNINGS AND CAUTIONS. USE THIS PRODUCT CORRECTLY AND WITH CARE FOR THE PURPOSE FOR WHICH IT IS INTENDED. FAILURE TO DO SO MAY CAUSE DAMAGE AND/OR PERSONAL INJURY AND WILL INVALIDATE THE WARRANTY. PLEASE KEEP INSTRUCTIONS SAFE FOR FUTURE USE.

1. SAFETY INSTRUCTIONS

1.1. GENERAL SAFETY

- ✓ Remove the battery pack from the drill before servicing or performing any maintenance.
- ✓ Maintain the drill and battery pack in good condition.
- ✓ Replace or repair damaged parts. *Use an authorised service agent and recommended parts only. Unauthorised parts may be dangerous and will invalidate the warranty.*
- ✓ Ensure battery pack is correctly inserted into the drill handle and latched in place before switching on drill.
- ✓ Ensure that the drill is switched off before installing the battery pack.
- ✓ Keep the drill, battery pack and charger clean for optimum performance.
- ✓ Remove ill fitting clothing. Remove ties, watches, rings and other loose jewellery and contain long hair.
- ✓ Evaluate the work area before using the drill - ceiling, floors and enclosures may contain electrical items or water piping.
- ✓ Secure loose workpieces with a clamp, vice or other adequate holding device. **DO NOT** hold workpiece in your hand.
- ✓ Avoid unintentional starting.
- ✓ Wear approved safety eye protection (standard spectacles are not adequate).
- ✓ Maintain correct balance and footing. Ensure that the floor is not slippery and wear non-slip shoes.
- ✓ Be aware that this drill does not need to be plugged into the mains power.
- ✓ Keep chuck direction switch in the locked position until the drill is required for use.
- ✓ Keep children and unauthorised persons away from the working area.
- x **DO NOT** use the drill where there are flammable liquids, solids or gases such as paint solvents, etc.
- x **DO NOT** allow children to operate the drill.
- x **DO NOT** operate the drill if any parts are missing as this may cause failure or possible personal injury.
- x **DO NOT** leave the drill operating whilst unattended.
- x **DO NOT** carry the drill with your finger on the power switch. Keep chuck direction switch in the locked position.
- x **DO NOT** use the drill for a task it is not designed to perform.
- x **DO NOT** operate the drill when you are tired or under the influence of alcohol, drugs or intoxicating medication.
- x **DO NOT** get the drill or battery charger wet or use in damp or wet locations.
- ✓ Keep drill and charger in the case and store in a safe, dry, childproof area where the temperature will not exceed 104°F (40°C).



1.2. BATTERY SAFETY INSTRUCTIONS

- **WARNING!** *The battery pack contains nickel-cadmium which is dangerous. It must therefore be handled with care to avoid damage, fire, corrosion or personal injury.*
- ✓ Charge battery pack prior to first use. The battery pack will have been shipped in a low charge state.
- ✓ Use only the charger provided to charge the battery pack.
- x **DO NOT** charge the battery pack when room temperature is below 50°F (10°C) or above 95°F (35°C).
- x **DO NOT** attempt recharging the pack by means of an engine generator or a DC power source.
- x **DO NOT** short-circuit the battery pack by touching both terminals with a metal object, or your fingers etc.
- x **DO NOT** store the battery pack (or drill) in locations where the temperature may exceed 104°F (40°C) - such as outside sheds, above heaters, or metal buildings in summer.
- **WARNING!** *Dispose of spent battery pack correctly as it contains nickel-cadmium. ▲ DANGER! DO NOT attempt to disassemble the battery pack. For safety and environmental reasons DO NOT discard in domestic waste or by burning. ONLY discard or recycle according to local authority regulations.*
- **WARNING!** *DO NOT allow a leaking battery to contact your person. If you come into contact with battery liquid take the following immediate action:*
 - a) **Skin contact:** *Wash immediately with soap and water, then wash flesh in either lemon juice or vinegar.*
 - b) **Eye contact:** *Wash with a strong solution of boric acid and seek immediate medical attention.*

1.3. MAINS POWER ELECTRICAL SAFETY (In relation to the battery charger)

□ **WARNING!** *It is the owner's responsibility to check the following:*

You must check all electrical equipment and appliances to ensure they are safe before using. **You must** inspect power supply leads, plugs and all electrical connections for wear and damage. **You must** ensure that the risk of electric shock is minimised by the installation of appropriate safety devices. An RCCB (Residual Current Circuit Breaker) should be incorporated in the main distribution board.

We recommend that an RCD (Residual Current Device) is used with all electrical products. It is particularly important to use an RCD with portable products that are plugged into a supply not protected by an RCCB. If in doubt consult a qualified electrician. You may obtain an RCD by contacting your dealer. **You must** also read and understand the following instructions concerning electrical safety.

- 1.3.1. The **Electricity At Work Act 1989** requires all portable electrical appliances, if used on business premises, to be tested by a qualified person, using a Portable Appliance Tester (PAT), at least once a year.
- 1.3.2. The **Health & Safety at Work Act 1974** makes owners of electrical appliances responsible for the safe condition of the appliance and the safety of the appliance operator. **If in any doubt about electrical safety, contact a qualified electrician.**
- 1.3.3. **DO** ensure that the insulation on all cables and the product itself is safe before connecting to the mains power supply. See 1.3.1. above and use a Portable Appliance Tester (PAT).
- 1.3.4. **DO** ensure that cables are always protected against short circuit and overload.
- 1.3.5. **DO** regularly inspect power supply leads, plugs and sockets for wear, damage or loose connections.
- 1.3.6. **DO** check that the voltage marked on the product is the same as the power supply to be used and check that all fused plugs are fitted with the correct capacity fuses.

- 1.3.7. DO NOT pull or carry the appliance by attached leads.
- 1.3.8. DO NOT pull plug from socket by the power cable.
- 1.3.9. **DO NOT** use worn or damaged cables, plugs or connectors. Immediately have any faulty item repaired or replaced by a qualified electrician. When a BS 1363/A UK 3 pin plug is damaged, cut the cable just above the plug and **dispose of the plug safely**. Fit a new plug according to the following instructions (UK only).
- Connect the GREEN/YELLOW earth wire to the earth terminal 'E'.
 - Connect the BROWN live wire to the live terminal 'L'.
 - Connect the BLUE neutral wire to the neutral terminal 'N'.
 - After wiring, check that there are no bare wires, that all wires have been correctly connected, that the cable outer insulation extends beyond the cable restraint and that the restraint is tight.

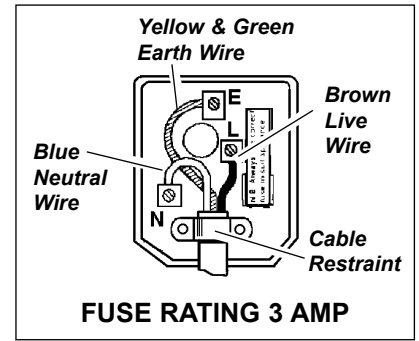

Double insulated products, which are always marked with this symbol , are fitted with live (brown) and neutral (blue) wires only. To rewire, connect the wires as indicated above. DO NOT connect either wire to the earth terminal.

1.4. BATTERY CHARGER SAFETY INSTRUCTIONS

- WARNING!** DO NOT attempt to charge any battery other than that supplied for the drill. Other types of batteries may explode!
- ✓ All mains electrical supply safety features must be followed as described in Section 1.3. above.
- ✓ Disconnect the charger from the mains power supply when not in use.
- ✗ DO NOT expose the charger to damp or wet conditions.
- ✗ DO NOT pull or carry the charger by the power lead.
- ✗ DO NOT operate the charger if it has been dropped, or has received a sharp knock, or is damaged. Take charger to an authorised agent.
- ✗ DO NOT dismantle the charger as this may cause damage or personal injury and will invalidate your warranty.
- ✗ DO NOT insert foreign objects or material into the hole reserved for the battery pack.
- ✗ DO NOT recharge a second battery pack immediately after charging the first. Consecutive charging will overheat the charger. Allow the unit to cool for 15 minutes before charging the next pack.
- ✗ DO NOT attempt to connect two chargers together.
- ✓ Store the charger in the same manner as the battery pack, see Section 1.2.

2. SPECIFICATIONS

Model: CP9918VHK

Chuck size10mm
 Motor18V
 Speed 10-350rpm
 Speed 20-1300rpm
 Max torque18Nm
 Impact rate0-5250/0-1950bpm
 Full charge time1 hour

Model: CP2018VHK.V2

Chuck size13mm
 Motor18V
 Speed 10-400rpm
 Speed 20-1450rpm
 Max torque31Nm
 Impact rate0-6000/0-2175bpm
 Full charge time1 hour

Fig. 1

- Keyless chuck
- Chuck shoulder
- Hammer selector
- 12-step torque control ring - CP9918VHK
- 22-step torque control ring - CP2018VHK.V2
- On/Off variable speed switch
- Lock, reverse and forward switch
- Two speed switch
- 18V battery pack
- Battery release button (one each side)

fig.1

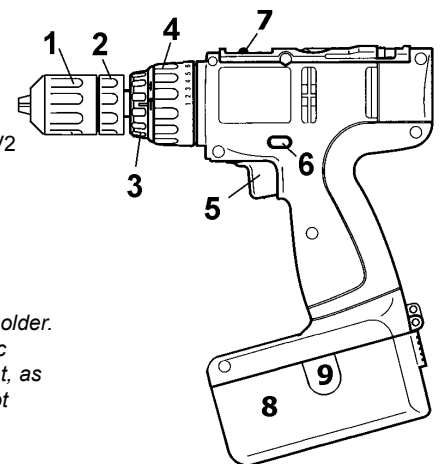

Note: On top of the drill is a one-piece tool bit holder. Immediately to the rear of this holder is a plastic housing designed to hold a chuck key. Note that, as the drill is fitted with a keyless chuck, it does not require, and does not have, a chuck key.

3. OPERATING INSTRUCTIONS

Note: When new, the battery pack will have been shipped in a low charge state. It will take longer to charge initially, and several subsequent charges may also take a little longer, than when the battery pack reaches optimum performance.

3.1. CHARGING THE BATTERY PACK

- To remove the battery pack (fig.2.A) from the drill, depress the two side release clips (fig.1.9).
 - WARNING!** Do not touch the battery terminals.
- Place the drill in the carry case and remove the battery charger (fig.2.B).
- The battery pack and charger have the positive (+) and negative (-) terminals marked. Align the terminals correctly and insert the battery (fig.2). *Note: The battery pack is designed so that it will only enter the charger unit the correct way.* When placed in the charger, a very slight downward pressure will seat the pack firmly into the power terminals.
- Connect the charger to mains power and switch on. The red light (fig.2.C) will glow indicating that the charge cycle has started.
- The red light will remain on until the battery pack is fully charged when it will go out and the green light (fig.2.C) will go on. Under normal conditions the battery will take up to 1 hour to fully charge.
- When the green light comes on, switch off the charger, unplug from the mains and remove the battery pack.
- Place the charger in the carry case. Insert the battery pack into the drill, ready for use.

fig.2

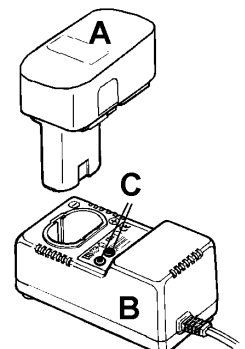

Note: Attempting to recharge a battery pack immediately after use may result in the red charge light not coming on. In such a case allow the battery to cool for a time and try again.

3.2. DRILLING INSTRUCTIONS (Ensure that you read, understand and comply with all the Section 1 safety instructions)

WARNING! Always wear approved safety glasses when drilling.

3.2.1. Preparation

1. Open the chuck by holding the rear collar (fig.3.2) and turn the front chuck collar (fig.3.1).
2. Insert the required bit fully into the chuck and tighten.
3. Check the drill to ensure the direction switch (fig.3.6) is in the mid (locked) position.
4. Fit the battery pack to the drill handle.
5. Press the direction switch (fig.3.6) in from the right, as you view drill from rear (as held), for clockwise rotation, and press in from the left for anti-clockwise rotation (withdrawing drill bits, undoing screws/nuts/bolts).

fig.3

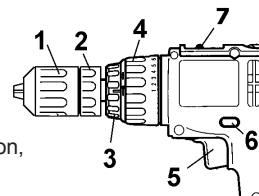

NOTE: Do not attempt to change direction of rotation while the drill is running.

3.2.2. Drill Speed

1. Speed of the drill is controlled by the electronic variable speed switch (fig.3.5). Press the switch gently for a slow speed and progressively increase the pressure on the switch to produce correspondingly higher speeds (try before starting to drill).
2. The maximum revolutions may also be adjusted by changing the two-speed switch (fig.3.7). See specifications for details.

NOTE: DO NOT change speed range whilst operating the drill.

3.2.3. Torque setting (fig.3.4)

Torque is the amount of turning force applied by the drill. Torque setting '1' on the dial (fig.3.4) is the lowest and will apply the least effort - to the final turns of a screw, for example. The torque becomes progressively greater with increased setting numbers, up to a maximum of '12' for CP9918VHK or '22' for CP2018VHK.V2. The combination of variable speed and variable torque gives maximum drilling/screw driving efficiency.

The lower torque settings are suitable for driving small screws and drilling with fine drill bits, to prevent shearing of the screws/bits. Screws/bits of larger diameter permit higher torque settings to be used.

3.2.4. As a screw or bolt driver

1. Lock the appropriate tool bit in the chuck. Select the shortest length bit possible to ensure greatest control.
2. A small pilot hole may be required to ease the path of the screw, especially in hard woods.
3. Set a low torque to begin with, gradually increasing the torque if necessary.
4. To remove screws, bolts, etc., press direction switch in from the left for reverse (anti-clockwise).
5. When finished, remove the bit from the chuck, clean drill and bit and store in the carry case.

3.2.5. Hammer action (fig.3.3)

WARNING! DO NOT use the hammer action with metal/wood drill bits as these may shatter. Use only with masonry bits.

The hammer action, with a masonry drill bit, is used to assist drilling into concrete, stone and masonry. To use the hammer function rotate the hammer control (fig.3.3) in the direction of the 'hammer' arrow. To disengage the hammer function turn the control back in the direction of the 'drill' arrow. *Note: DO NOT shift to 'hammer' when the drill is running as this may damage the machine.*

3.2.6. Drilling

WARNING! Ensure that you read and understand Section 1 safety instructions before using the drill.

1. If the workpiece to be drilled is loose it should be secured in a vice or with clamps to keep it from turning as the drill bit rotates.
2. When drilling metals, use a light oil on the drill bit to keep it from overheating. Oil will prolong bit life and improve the drilling action.
3. For hard, smooth surfaces use a centre punch to mark desired hole location. This will prevent bit from slipping as you start to drill.
4. A pilot hole may be necessary to assist the final size drill through the workpiece.
Lock a pilot drill (smaller size drill than the required hole size) in the chuck. Follow steps 5 to 9 below and drill a pilot hole at the centre punch mark where final hole is to be drilled. Insert the final sized bit. Hold drill firmly, place the tip of the bit in the pilot hole and depress the trigger.
5. Hold drill firmly and place the bit tip on the point to be drilled.
6. Depress the trigger to start drill. Move the drill bit into the workpiece applying only enough pressure to keep the bit cutting. DO NOT force the drill or apply side pressure to elongate the hole.
7. Regularly withdraw the drill bit from the hole in order to clear cuttings.
8. Ease the pressure of drilling when the bit is about to break through the far side of the workpiece.

WARNING! Be prepared for drill bit binding or break through. When these situations occur the bit has a tendency to grab and the drill will kick, which could cause loss of control. If you are not prepared, this loss of control may result in damage and/or personal injury.

9. If the bit jams in the workpiece or if the drill stalls, release the trigger switch immediately. Place the drill in reverse to assist release of the bit.
10. After a long period of continuous operation, allow the drill to run with no load and at maximum speed to cool the motor.

WARNING! Drill bits can become very hot during use. Allow to cool or hold with a cloth for removal.

When finished, remove bit from chuck, clean drill, clean, and, if necessary, re-sharpen bit and store in a safe, dry, childproof area.

4. MAINTENANCE

4.1. Cleaning

Keep the drill ventilation slots clean and free from obstructions. If available, blow compressed air into the vents to clear any accumulated dust (safety goggles must be worn when undertaking this process).

Keep the outer case of the drill clean and free from grease. DO NOT wash with water or use solvents or abrasives.

5. DECLARATION OF CONFORMITY

Declaration of Conformity We, the sole importer into the UK, declare that the products listed here are in conformity with the following standards and directives.

Cordless Hammer Drill & Battery Charger
Models: CP9918VHK & CP2018VHK.V2

73/23/EEC LV Directive
89/336/EEC EMC Directive
98/37/EC Machinery Directive
2002/95/EC RoHS Directive
2002/96/EC WEEE Directive
93/68/EEC CE Marking Directive



The construction files for these products are held by the Manufacturer and may be inspected, by a national authority, upon request to Jack Sealey Ltd.

Signed by Tim Thompson  10th May 2007

For Jack Sealey Ltd. Sole importer into the UK of Sealey Power Products.

NOTE: It is our policy to continually improve products and as such we reserve the right to alter data, specifications and component parts without prior notice.

IMPORTANT: No responsibility is accepted for the incorrect use of this product.

WARRANTY: Guarantee is 12 months from purchase date, proof of which will be required for any claim.

INFORMATION: For a copy of our latest catalogue and promotions, call us on 01284 757525 and leave your full name and address, including post code.



Sole UK Distributor,
Sealey Group,
Bury St. Edmunds, Suffolk.

 01284 757500

 01284 703534

 sales@sealey.co.uk

 www.sealey.co.uk