



UNIVERSAL CVJ BOOT CLAMP KIT

MODEL No: **BSL102**

Thank you for purchasing a Sealey product. Manufactured to a high standard, this product will, if used according to these instructions, and properly maintained, give you years of trouble free performance.

IMPORTANT: PLEASE READ THESE INSTRUCTIONS CAREFULLY. NOTE THE SAFE OPERATIONAL REQUIREMENTS, WARNINGS & CAUTIONS. USE THE PRODUCT CORRECTLY AND WITH CARE FOR THE PURPOSE FOR WHICH IT IS INTENDED. FAILURE TO DO SO MAY CAUSE DAMAGE AND/OR PERSONAL INJURY AND WILL INVALIDATE THE WARRANTY. KEEP THESE INSTRUCTIONS SAFE FOR FUTURE USE.



Refer to instruction manual



Wear eye protection



Wear protective gloves

1. SAFETY INSTRUCTIONS

1.1 GENERAL SAFETY

- ✓ Carefully read these operating and safety instructions before use. Keep them for future reference.
- ✓ Keep the work area clean, uncluttered and ensure there is adequate lighting.
- ✓ Maintain correct balance and footing. Ensure the floor is not slippery and wear non-slip shoes.
- ✓ Remove ill fitting clothing. Remove ties, watches, rings, and other loose jewellery, and contain and/or tie back long hair.
- ✓ Keep children and unauthorised persons away from the working area.
- ✗ **DO NOT** use the clamp tool for any purpose other than that for which it is designed.
- ✗ **DO NOT** operate the clamp tool when you are tired or under the influence of alcohol, drugs or intoxicating medication.

☐ **WARNING!** Ensure Health & Safety, local authority, and general workshop practice regulations are adhered to when using this equipment.

1.2 MECHANICAL SAFETY

- ✓ Maintain the clamp tool in good condition.
- ✗ **DO NOT** operate the clamp tool if any parts are damaged or missing as this may cause failure and/or personal injury.

1.3 OPERATIONAL SAFETY

- ✓ When working with the clamp tool you are advised to use protective equipment including safety shoes, work gloves and safety goggles.
- ✓ Never insert fingers into the tool.

2. INTRODUCTION

Fast and simple-to-use. Kit includes 55m high quality stainless steel banding with a tensile strength of 420N/mm². The dispenser case also houses 150pc* clamp sets and unique pliers with integrated cutters and band tensioner. Never be caught without the right sized boot clamp again. (*approximate number)

3. SPECIFICATION

Model no. BSL102
 Band length 55m
 Band size 5.5 x 0.4mm
 Clamps/buckles 150 (approximate)
 Weight 1.45kg

4. OPERATION

4.1. The four positions of the pliers are as follows.

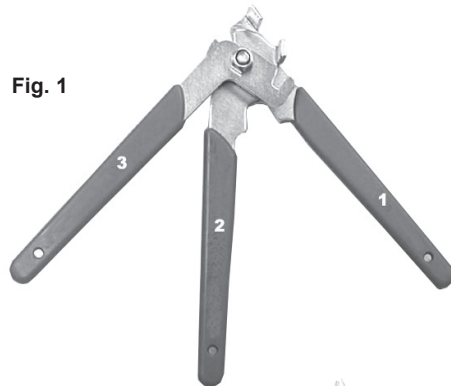

Fig. 1

Position 1



Fig. 2

Position 2

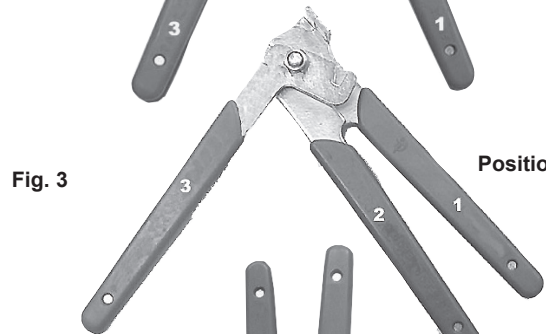

Fig. 3

Position 3



Fig. 4

Position 4

4.2. Use the ruler, marked on the cassette, to measure the correct length. (Fig.5)

4.3. Cut the band, using plier position 2, handles 2 & 3 held together. (Fig.6)

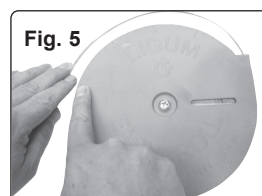

Fig. 5

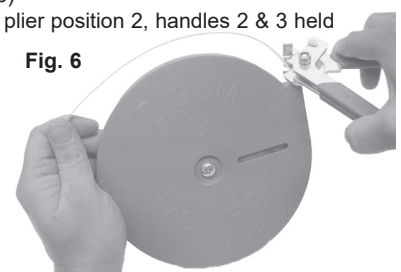

Fig. 6

- 4.4. Insert the band through a seal. (Fig.7)
- 4.5. Bend the band tail under the seal (1cm length). (Fig.8)

Fig. 7



Fig. 8



- 4.6. Crimp the tail to the seal using the pliers (plier position 4). (Fig.9)
- Ensure the pliers tongs touch the two legs of the seal as in Fig.10. When crimped it should look as (Fig.11).

Fig. 9

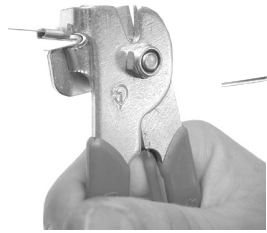

Fig. 10

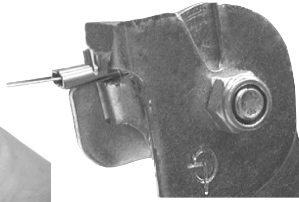

Fig. 11



- 4.7. Place the band over the CV Boot. Pull the slack through the seal, bending the band up slightly to prevent it from slipping back through the seal. (Fig.12)

Fig. 12

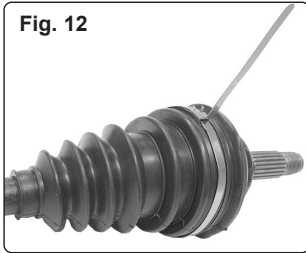
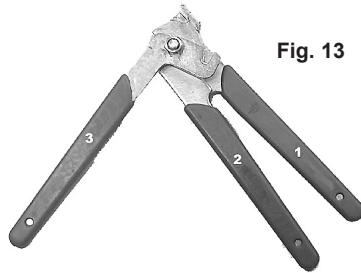

Fig. 13



- 4.8. Split plier handles 1 & 2 from handle 3 (Fig.13).
- 4.9. Place the tail inside the plier (Fig.14).
- 4.10. Close the pliers trapping the tail between the jaws of handles 3 & 2. (Fig.15)

Fig. 14



Fig. 15

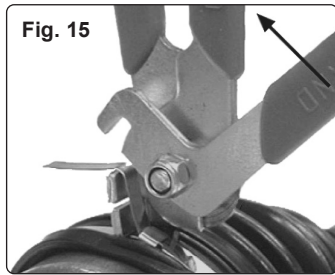

- 4.11. Holding the handles locked, rock the pliers away from the seal to take up the slack. (Fig.16)

Fig. 16

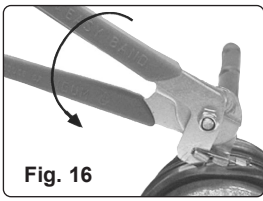

Fig. 17

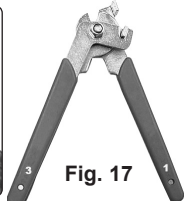
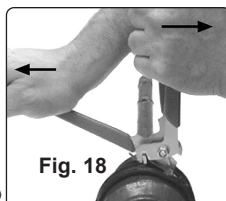

Fig. 18



- 4.12. Holding handles 2 & 3 in one hand and handle 1 in the other (Fig.17), tighten the band by pulling the handles in opposite directions until the required tension is achieved. (Fig.18)
- 4.13. Whilst holding the tension, rock the plier back until number 3 handle is lying across the seal. This will bend back the band to ensure it does not slip back through the seal. (Fig.19)
- 4.14. At this point you can remove the plier taking care that the band tension is not released. (Fig.20)

Fig. 19

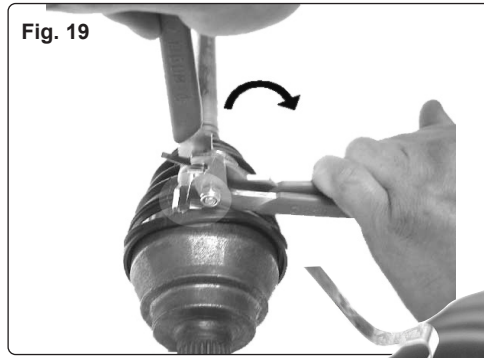

Fig. 20



- 4.15. Cut off the remaining tail leaving 1 cm. (Fig.21) Use plier position 2. (Fig.22)

Fig. 21

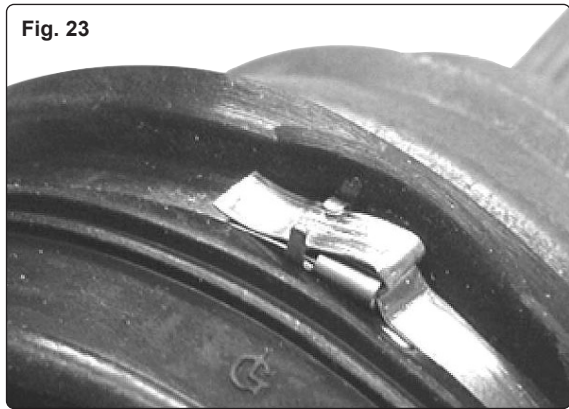

Fig. 22



- 4.16. Bend the tail back over the seal and secure in place with the two seal legs. (Fig.23)

Fig. 23



ENVIRONMENT PROTECTION

Recycle unwanted materials instead of disposing of them as waste. All tools, accessories and packaging should be sorted, taken to a recycling centre and disposed of in a manner which is compatible with the environment. When the product becomes completely unserviceable and requires disposal, drain any fluids (if applicable) into approved containers and dispose of the product and fluids according to local regulations.

Note: It is our policy to continually improve products and as such we reserve the right to alter data, specifications and component parts without prior notice.

Important: No Liability is accepted for incorrect use of this product.

Warranty: Guarantee is 12 months from purchase date, proof of which is required for any claim.



REGISTER YOUR PURCHASE HERE

Sealey Group, Kempson Way, Suffolk Business Park, Bury St Edmunds, Suffolk. IP32 7AR



01284 757500



sales@sealey.co.uk



www.sealey.co.uk