

SEALEY

BATTERY SUPPORT UNIT & CHARGER

12V-25A /24V-12.5A

MODEL No: **BSCU25.V2**

Thank you for purchasing a Sealey product. Manufactured to a high standard, this product will, if used according to these instructions, and properly maintained, give you years of trouble free performance.

IMPORTANT: PLEASE READ THESE INSTRUCTIONS CAREFULLY. NOTE THE SAFE OPERATIONAL REQUIREMENTS, WARNINGS & CAUTIONS. USE THE PRODUCT CORRECTLY AND WITH CARE FOR THE PURPOSE FOR WHICH IT IS INTENDED. FAILURE TO DO SO MAY CAUSE DAMAGE AND/OR PERSONAL INJURY AND WILL INVALIDATE THE WARRANTY. KEEP THESE INSTRUCTIONS SAFE FOR FUTURE USE.



Refer to instructions



Wear eye protection



Wear protective gloves



Electrical shock hazard



Warning corrosive substance



Warning: explosive material



Keep away from sources of ignition

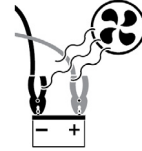

Use in well ventilated areas



Keep away from rain

1. SAFETY

1.1. ELECTRICAL SAFETY

- ❑ **WARNING!** It is the user's responsibility to check the following:

Check all electrical equipment and appliances to ensure that they are safe before using. Inspect power supply leads, plugs and all electrical connections for wear and damage. Sealey recommend that an RCD (Residual Current Device) is used with all electrical products.

If the charger is used in the course of business duties, it must be maintained in a safe condition and routinely PAT (Portable Appliance Test) tested.

Electrical safety information, it is important that the following information is read and understood.

Ensure that the insulation on all cables and on the appliance is safe before connecting it to the power supply.

- 1.1.1. Inspect power supply cables and plugs regularly for wear or damage and check all connections to ensure that they are secure.
- 1.1.2. Ensure that the voltage rating on the appliance suits the power supply to be used and that the plug is fitted with the correct fuse - see fuse rating in these instructions.
 - × **DO NOT** pull or carry the appliance by the power cable.
 - × **DO NOT** pull the plug from the socket by the cable. Remove the plug from the socket by maintaining a firm grip on the plug.
 - × **DO NOT** use worn or damaged cables, plugs or connectors. Ensure that any faulty item is repaired or replaced immediately by a qualified electrician.

1.1.3. This product is fitted with a BS1363/A 13 Amp 3 pin plug.

1.1.4. If the cable or plug is damaged during use, switch the electricity supply off and remove from use.

1.1.5. Replace a damaged plug with a BS1363/A 13 Amp 3 pin plug. If in doubt contact a qualified electrician.

1.1.6. Class II products are wired with live (brown) and neutral (blue) only and are marked with the Class II symbol:

A) Connect the BROWN live wire to the live terminal 'L'.

B) Connect the BLUE neutral wire to the neutral terminal 'N'.

C) After wiring, check that there are no bare wires and ensure that all wires have been correctly connected.



1.1.7. Ensure that the cable outer sheath extends inside the cable restraint and that the restraint is tight.

- × **DO NOT** connect either wire to the earth terminal.

Sealey recommend that repairs are carried out by a qualified electrician.

- ▲ **DANGER! BE AWARE, LEAD-ACID BATTERIES GENERATE EXPLOSIVE GASES DURING NORMAL BATTERY OPERATION. FOR THIS REASON, IT VERY IMPORTANT TO READ AND FOLLOW THESE INSTRUCTIONS CAREFULLY, EACH TIME YOU USE THE CHARGING EQUIPMENT.**

1.1.8. Follow these instructions and those published by the battery and vehicle manufacturers, and the maker of any equipment you intend to use in the vicinity of the battery. Review warning marks on all products and on engines.

- ❑ **WARNING!** Modern vehicles contain extensive electronic systems.

Check with the vehicle Manufacturer for any specific instructions regarding the use of this type of equipment on each vehicle.

No liability will be accepted for damage / injury, where this product is not used in accordance with all instructions.

1.2. PERSONAL PRECAUTIONS

- ✓ Ensure there is another person within hearing range of your voice and close enough to come to your aid, should a problem arise when working near a lead-acid battery.
- ✓ Wear safety eye protection and protective clothing. Avoid touching eyes while working near battery.
- ✓ Have fresh water and soap nearby in case battery acid contacts skin, clothing or eyes.
- ✓ Wash immediately with soap and water if battery acid contacts skin or clothing. If acid enters eye, flush eye immediately with cool, clean running water for at least 15 minutes and seek immediate medical attention.

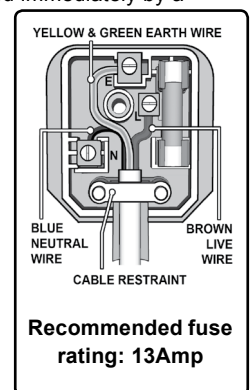

- ✓ Remove personal metallic items such as rings, bracelets, necklaces and watches. A lead-acid battery can produce a short-circuit current which is high enough to weld a ring or the like to metal, which would cause severe burns.
- ✓ Ensure hands, clothing (especially belts) are clear of fan blades and other moving or hot parts of engine, remove ties and contain long hair.
- ✗ **DO NOT** smoke or allow a spark or flame in the vicinity of battery or engine.

1.3. GENERAL SAFETY INSTRUCTIONS

- ✓ Familiarise yourself with the application and limitations of the charger as well as the potential hazards. Also refer to the vehicle manufacturer's hand book. **IF IN ANY DOUBT CONSULT A QUALIFIED ELECTRICIAN.**
 - ✓ Ensure the charger is in good order and condition before use. If in any doubt do not use the unit, contact your Sealey stockist.
 - ✓ Ensure the charger is disconnected from the mains supply before attaching/detaching the power clamps to/from the battery.
 - ✓ Keep tools and other items away from the engine and ensure you can see the battery and working parts of engine clearly.
 - ✓ Ensure the output of the charger is the same voltage as the battery.
 - ✓ Ensure that during charging, the charger is placed in a location where there is sufficient ventilation to prevent the build up of explosive gases from a lead acid battery.
 - ✓ If battery has caps to access the battery fluid, remove the caps and check the fluid level before connecting the power clamps. If necessary top-up the battery with distilled water by referring to the battery manufacturer's instructions (Apply the personal safety precautions described in part 1.2).
 - ✓ If the charger receives a sharp knock or blow the unit must be checked by a qualified service agent before using.
 - ✓ If the battery terminals are corroded or dirty, clean them before attaching the power clamps.
 - ✓ Keep children and unauthorised persons away from the working area.
 - ✗ **DO NOT** dismantle the charger for any reason. The charger must only be checked by qualified service personnel.
 - ✗ **DO NOT** try to charge a non-rechargeable battery.
 - ✗ **DO NOT** try to start engine when charger is connected to battery.
 - ✗ **DO NOT** try to charge battery if battery fluid is frozen.
 - ☐ **WARNING!** To prevent the risk of sparking, short circuit and possible explosion **DO NOT** drop metal tools in the battery area, or allow them to touch the battery terminals.
 - ✗ **DO NOT** allow power clamps to touch each other or to make contact with any metallic part of the vehicle.
 - ✗ **DO NOT** cross connect power leads from charger to battery. Ensure positive (+/RED) is to positive and negative (-/BLACK) is to negative.
 - ✗ **DO NOT** pull the cables or clamps from the battery terminals.
 - ✗ **DO NOT** use the charger outdoors, or in damp, or wet locations and **DO NOT** operate within the vicinity of flammable liquids or gases.
 - ✗ **DO NOT** use charger inside vehicle or inside engine compartment.
 - ✗ **DO NOT** use the charger for a task for which it is not designed.
 - ☐ **WARNING! DO NOT** simultaneously charge batteries of different capacities or discharge levels.
 - ☐ **WARNING!** If a fuse blows, ensure it is replaced with an identical fuse type and rating. Use only Sealey genuine parts.
 - ✓ When not in use, store the charger carefully in a safe, dry, childproof location.
- NOTE: This appliance can be used by children aged from 8 years and above and persons with reduced physical, sensory or mental capabilities or lack of experience and knowledge if they have been given supervision or instruction concerning use of the appliance in a safe way and understand the hazards involved. Children shall not play with the appliance. Cleaning and user maintenance shall not be made by children without supervision.**

2. INTRODUCTION

High frequency inverter type unit designed to both charge a battery and provide support for the battery during prolonged electronic diagnostic checks. Charge cycle has 9 profiles designed to optimise the condition of the battery and the speed of the charge. It will recover a discharged battery (>2V) to almost 100% of its original capacity. Designed for use with lead acid and lead calcium batteries including WET, AGM/GEL and VRLA types on 12V and 24V systems. Temperature sensor allows accurate charging of battery, even when cold. Safety circuitry prevents sparks or polarity reversal. Once fully charged, battery may be left connected to be automatically conditioned and maintained.

3. SPECIFICATION

Model No:.....**BSCU25**
 Type: 9-Cycle with Support
 Supply:230V
 Output: 12V/24V
 Output charge: 12V-25A, 24V-12.5A
 Battery support mode:.....<300W
 Weight:..... 2.5kg

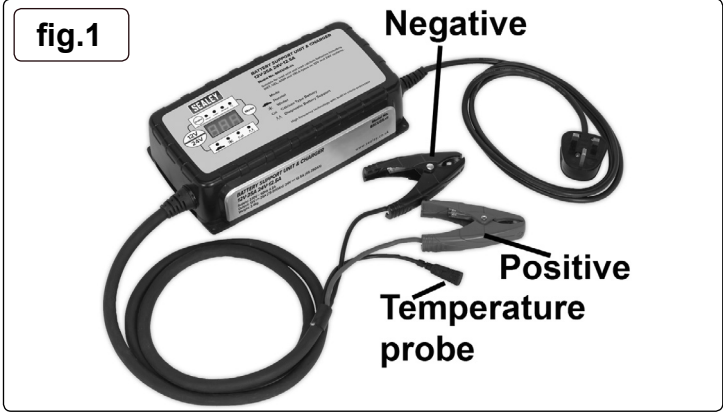

4. OPERATION

- ### 4.1. PREPARATION
- IMPORTANT!** It is important to prepare for charging correctly ensuring you follow Section 1 safety regulations carefully. Check that the capacity of the battery is compatible with the charger output.
- 4.1.1. Follow any vehicle manufacturer's instructions for charging the battery. Especially instructions for charging batteries which should not ordinarily be removed from the vehicle for this process.
- 4.1.2. If the battery is removed, place in an appropriate safe area, according to Section 1, ready for charging.
IMPORTANT! a boat battery must be removed and charged on shore.
- ### 4.2. CONNECTING THE CHARGER TO A BATTERY INSTALLED ON THE VEHICLE.
- 4.2.1. Ensure the charger black and red crocodile clips are not short circuited at any time.
- 4.2.2. Identify the polarity of the battery terminals and check that they are free of corrosion deposits. Clean if required.
- 4.2.3. Identify the polarity of the battery terminal connected to the vehicle chassis (earth), normally the negative terminal.
- 4.2.4. Identify the system voltage of the vehicle, 12V or 24V.
- 4.2.5. Remove the battery electrolyte cover or caps, when applicable, to allow the gases produced by charging to escape.
- 4.2.6. If not a sealed battery, check electrolyte levels. Add distilled water in each cell according to manufacturer's instructions or 5-10 mm above the plates if information not available. For sealed batteries refer to manufacturer's recharging instructions.

- 4.2.7. Connect the charger POSITIVE (Red or +) lead to the POSITIVE (+) terminal of the battery and the NEGATIVE (Black or -) lead to the NEGATIVE (-) terminal of the battery. Lay the temperature probe in close proximity to the battery (fig.1).
- 4.2.8. Plug the charger into the electrical supply and switch on. The LED will flash "000"; the 'standby status' in table (Section 6). Select either 12V or 24V on the selector switch, a green LED will be illuminated against the selected voltage.
- 4.3. CONNECTING THE CHARGER TO A BATTERY NOT INSTALLED OR TO BE REMOVED FROM THE VEHICLE.**
- 4.3.1. Check the battery to ensure the NEGATIVE & POSITIVE terminals are clearly identifiable before removing the battery from the vehicle.
- 4.3.2. Disconnect and remove the battery from the vehicle and place in an appropriate safe well ventilated area ready for charging.
- 4.3.3. Follow instructions 4.2.6 to 4.2.8.
- 4.3.4. The charging status of a battery will be displayed digitally in the LED window of the charger, it can also be determined by use of a hydrometer which measures the specific gravity of the electrolyte. The following information indicates kg/l at 20°C:

1.28 = Fully charged 1.21 = Half charged 1.14 = Fully discharged battery.

- ❑ **WARNING!** Take care as the electrolyte is highly corrosive.
- 4.4. CHARGING THE BATTERY** - Referring to the graphs (fig.6 and fig.7), the projected voltage is represented by the lower line and the projected current is represented by the upper incremental line. Stages and time are represented by the numbers 1 - 9 (fig.6) for lead acid batteries and 1 - 10 (fig.7) for lead calcium acid batteries.
- 4.4.1. Select the required charging mode (fig.3) by pressing the "MODE" button (fig.4). The 'vehicle' icon indicates normal charging, the 'snowflake' icon indicates low temperature environment charging, the 'Cal' indicates calcium type battery charging and is also a repair mode for sulphated batteries. The 'battery clips' icon indicate battery support mode, this mode provides power for the battery during prolonged electronic diagnostic checks. **If either the 'Cal' icon or the 'battery clip' icon mode is required; from the initial flashing "000" standby mode, press the mode button in quick succession** (*before the "R E P" appears in the LED window) **and follow the illuminated icon indicators to the required mode.** Press three times for "Cal", four times for 'battery clips', five times for back to standby status. For further explanation of charging modes see table fig.6. *If a charging mode selection is made, after a few seconds "R E P" appears in the LED window; this extinguishes after 5 flashes to read the selected 'voltage/current/charging %' from fig.4. Selection of 'Cal' (amber) and 'battery clip icon' (red) are now inhibited and cannot be selected.

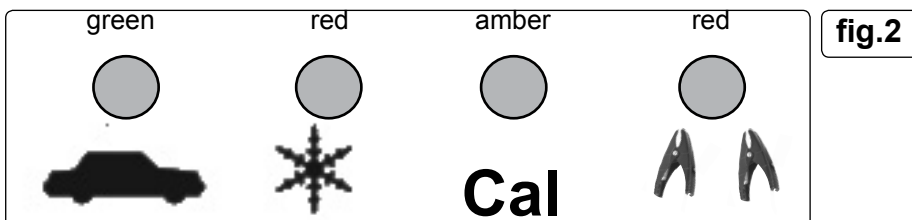

- 4.4.2. Select the required 3 figure digital display by pressing the "display" button (fig.3) for 'voltage', press again for 'current' and again for 'charging %'. The exclamation mark indicates a fault condition. Inboard short circuit protection and overload protection instantly shuts the charger down in a fault condition. For further explanation of displayed LED readings see table fig.5.

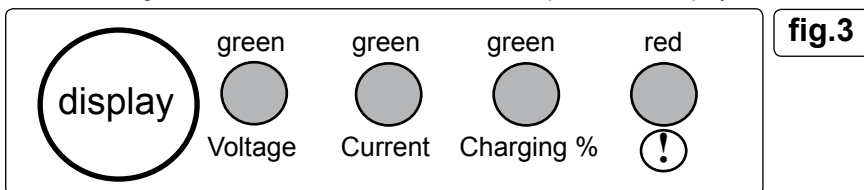

- 4.4.3. Check the current delivery to the battery by pressing the "display" button (fig.3). Initially, there will be a high rate of charge which will decrease slowly according to the capacity and condition of the battery. Press again for 'current' and again for 'charging %' values.
- 4.4.4. When fully charged the ammeter reading 'current' should be "0.00" or close to "0.00" and the electrolyte in the battery should begin to gas (not visible on vented sealed for life modern batteries). Press the "display" button to check the 'charging %', if the LED reads "F U L" the battery is fully charged. If the LED reads "C H E" (stage 9 in graphs), wait whilst the charger checks the battery. If the battery is charged fully the LED will normally change to "F U L" within 60 seconds.
- 4.4.6. Unless battery support mode is required, isolate mains power and unplug charger from the mains. On completion of all tasks disconnect the power clamps, the earthed clamp first, clean the charger and store in a safe, dry area.
- 4.4.7. Replace the battery electrolyte cover or caps when applicable. Wipe up any splashes or spillage. Return the battery to the vehicle, if required, secure according the manufacturer's instructions and re-connect the power leads. Check to ensure all tools are removed before closing the bonnet.

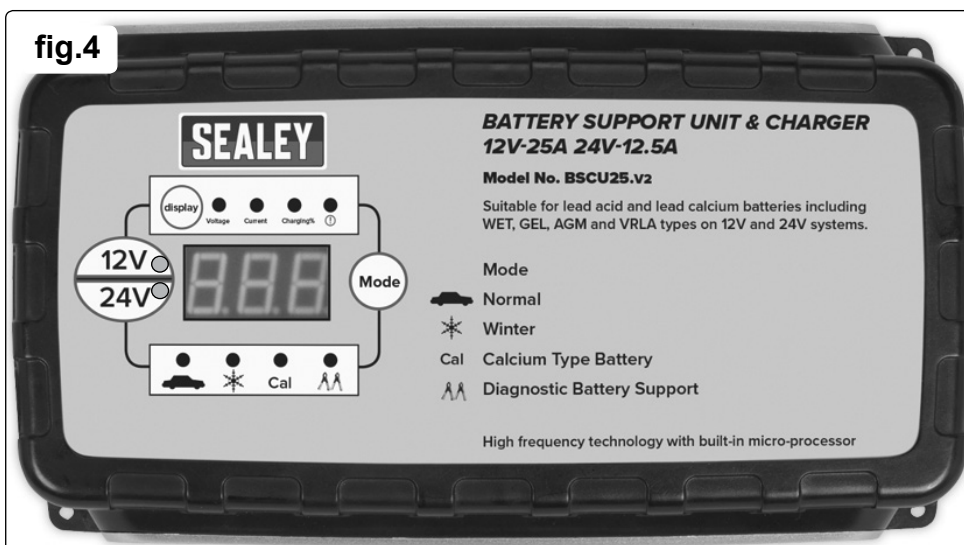











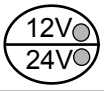

	Select the required voltage. A single press of the button will change voltage illuminating a green indicator.		Digital LED display to show Voltage, Current, and Charging %. It will also display status, functions and fault conditions. See section on Trouble Shooting.
	To select charging mode or re-set during charging. A single press of the button moves to next mode.		Press display button once to illuminate Voltage, press again to illuminate Current, press again to illuminate Charging %. Read values in the LED window.
	Mode : 14.4V 25.0A or 28.8V 12.5A. This mode is normally used for all types of batteries. On selection the charger cooling fan starts.		Read values in the LED window.
	Mode : 14.7V 25A or 29.4V 12.5A. This setting is recommended at temperatures below 5°C. Not recommended when temperatures exceed 5°C.		Read values in the LED window.
	Mode : Calcium select for all calcium batteries. Also batteries with voltages below 10.5V without capacity to absorb charging current. The charger will automatically pulse charge up to 16V to recover battery. If the battery cannot be recovered after 2 hours a fault (!) icon will illuminate. New battery required.		Read values in the LED window.
	Mode : DC supply (13.5V 25A) Provides support for the battery during prolonged electronic diagnostic checks.		When the exclamation mark indicator illuminates, it is accompanied by a high pitched audible alarm. A fault condition has been detected and will be identified in the LED window as F 0 1, F 0 2, F 0 3, F 0 4 and F 0 5, see section 6 "TROUBLE SHOOTING".

fig.5



- Charging stages (9 steps)
- 1 - Qualification
 - 2 - Battery recovery
 - 3 - Soft start
 - 4 - Pulse mode
 - 5 - Recondition
 - 6 - Bulk
 - 7 - Absorption
 - 8 - Equalisation
 - 9 - Check



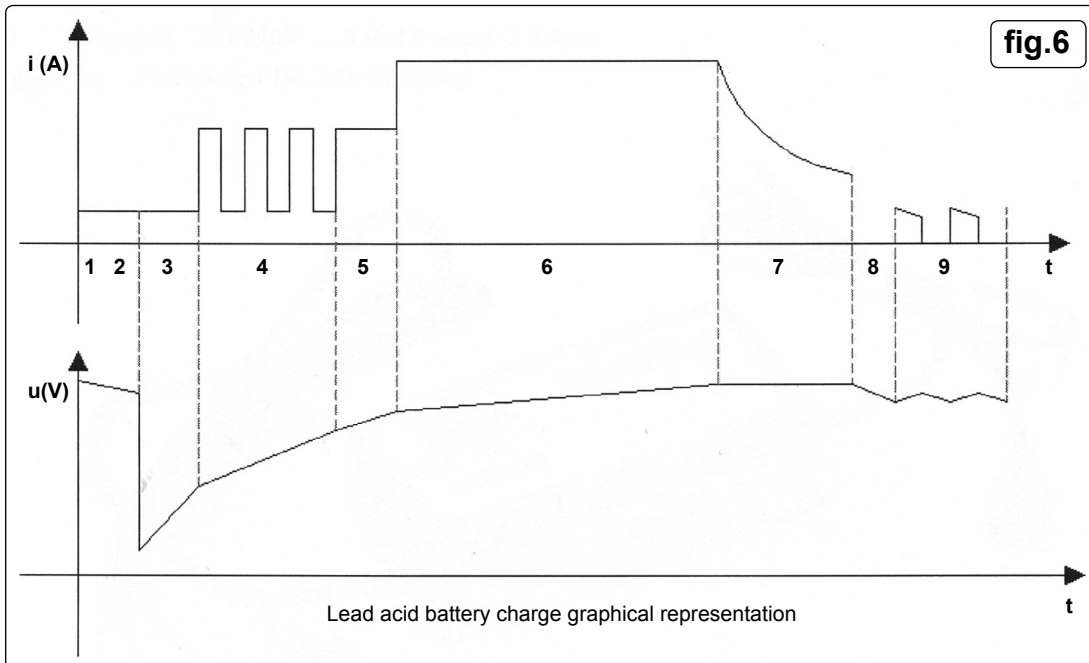
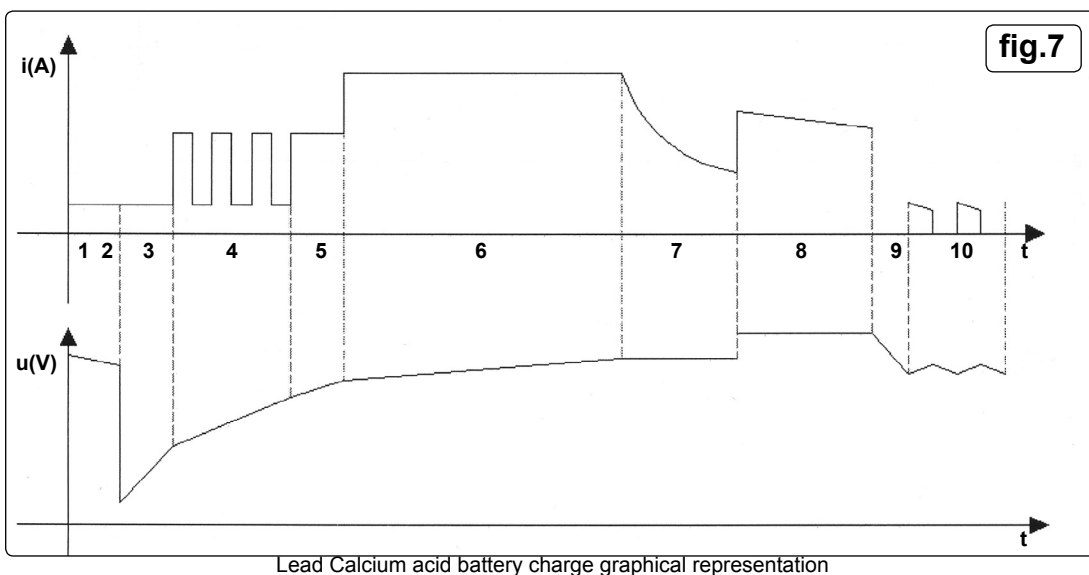







- Charging stages (9 steps)
- 1 - Qualification
 - 2 - Battery recovery
 - 3 - Soft start
 - 4 - Pulse mode
 - 5 - Recondition
 - 6 - Bulk
 - 7 - Absorption
 - 8 - Equalisation
 - 9 - Check
 - 10- Maintenance

5. MAINTENANCE

- 5.1. After each use clean the charger clamps, removing corrosive battery fluids.
- 5.2. Clean the charger casing and charger leads with a soft cloth and mild detergent solution.
- 5.3. Keep the charger leads loosely coiled during storage without snagging or crushing.
- × **DO NOT** attempt to repair damaged leads, these must be replaced by your Sealey service agent or a qualified person.
 - × **DO NOT** attempt to repair charger electronics, this must be done by your Sealey service agent or a qualified person.

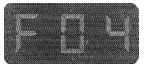
6. TROUBLESHOOTING

CODES	DESCRIPTION	TROUBLESHOOTING
	Standby status.	
	Check battery status before charging.	Battery already fully charged.
	Charger is repairing battery.	Temporary indication of start. Repair mode for sulphated batteries.
	1) No connection to battery. 2) Short circuit. 3) Reversed polarity connection.	1) Reconnect terminal. 2) Check all connections. 3) Reverse connections.
	Clip loosened during charging. The charger stops, an audible alarm will sound in 25 secs.	Check connections and start charging process again.
	Battery voltage too high.	Battery voltage not as voltage setting.
	Current leakage inside battery.	Start charging again, if fault condition re-occurs, replace battery.
	Charger internal temperature too high.	Cooling fan not working. Ambient temperature too high, (40°C).
	Battery fully charged. Voltage held until power restored.	



WEEE REGULATIONS

Dispose of this product at the end of its working life in compliance with the EU Directive on Waste Electrical and Electronic Equipment (WEEE). When the product is no longer required, it must be disposed of in an environmentally protective way. Contact your local solid waste authority for recycling information.



ENVIRONMENT PROTECTION

Recycle unwanted materials instead of disposing of them as waste. All tools, accessories and packaging should be sorted, taken to a recycling centre and disposed of in a manner which is compatible with the environment. When the product becomes completely unserviceable and requires disposal, drain any fluids (if applicable) into approved containers and dispose of the product and fluids according to local regulations.

Note: It is our policy to continually improve products and as such we reserve the right to alter data, specifications and component parts without prior notice. Please note that other versions of this product are available. If you require documentation for alternative versions, please email or call our technical team on technical@sealey.co.uk or 01284 757505.

Important: No Liability is accepted for incorrect use of this product.

Warranty: Guarantee is 12 months from purchase date, proof of which is required for any claim.

Sealey Group, Kempson Way, Suffolk Business Park, Bury St Edmunds, Suffolk. IP32 7AR



01284 757500



01284 703534



sales@sealey.co.uk



www.sealey.co.uk



EC DECLARATION OF CONFORMITY

Description and Function: **Battery Support Unit & Charger 12V-25A/24V-12.5A**

Model/Type: **BSCU25 v2**

Manufacturing Date/Serial Number (optional):

- 2006/42/EC Machinery Directive
- 2014/35/EU Low Voltage Directive
- 2014/30/EU EMC Directive
- 2009/125/EC Ecodesign Requirements
- 2009/142/EC Gas Appliance Directive
- 2014/29/EU Simple Pressure Vessels Directive
- 2000/14/EC Noise Emission in the Environment Directive
- 2012/19/EU WEEE Directive
- 2011/65/EU RoHS Directive
- 2014/68/EU Pressure Equipment Directive
- 89/686/EEC PPE Directive
- 2014/53/EU RTTE Directive

Manufacturer's authorised representative within the EC: **Jack Sealey Ltd, Kempson Way, Suffolk Business Park, Bury St Edmunds, Suffolk. IP32 7AR**

Conforms to the requirements of the Directives, as indicated.

And the following harmonised standard(s)

- EN 60335-1:2002+A11:2004+A12:2006+A2:2006+A13:2008+A14:2010.....
- EN 60335-2-29:2004+A2:2010.....
- EN 62233:2008.....
- EN 55014-1:2006+A1:2009.....
- EN 61000-3-2:2006+A1:2009+A2:2009.....
- EN 61000-3-3:2008.....
- EN 55014-2:1997+A1:2001+A2:2008.....

Technical file compiled by: **Jack Sealey Ltd**

Being the responsible person appointed by the manufacturer.

Signed..... 

Date..... 21 October 2016

Name..... Steve Buckle.

Position..... Marketing Director.

Place: Bury St Edmunds

Sealey Power Products Kempson Way,
Suffolk Business Park, Bury St Edmunds,
Suffolk. IP32 7AR

 01284 757500  01284 703534  sales@sealey.co.uk  www.sealey.co.uk



Parts Information:
Battery Support Unit & Charger
 12V-25A/24V-12.5A
Model No: BSCU25.V2

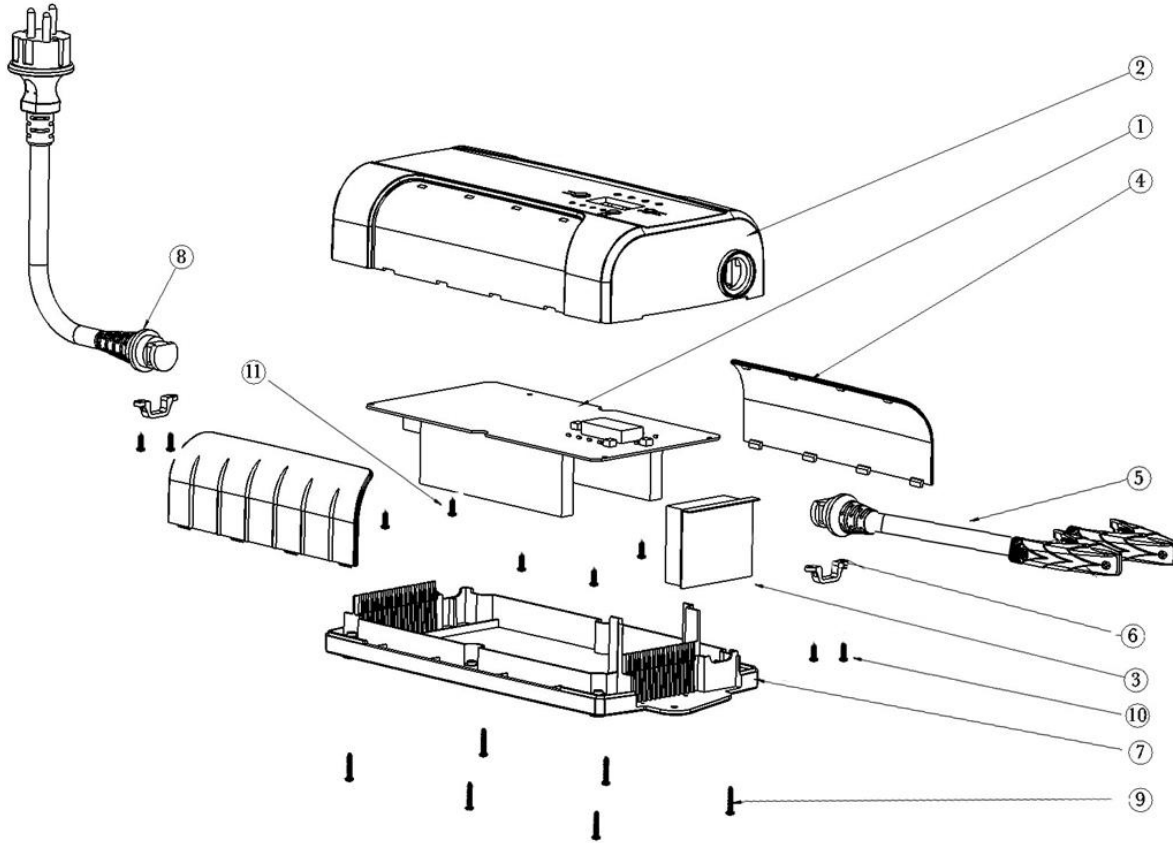

Item	Part No.	Description
1	BSCU25.V2-01	PCB
2	BSCU25.V2-02	UPPER COVER
3	BSCU25.V2-03	FAN
4	BSCU25.V2-04	SIDE COVER
5	BSCU25.V2-05	CLAMPS (C/W)
6	BSCU25.V2-06	CLAMP CLIP

Item	Part No.	Description
7	BSCU25.V2-07	BOTTOM COVER
8	BSCU25.V2-08	CABLE (c/w P)
9	BSCU25.V2-09	SCREW (3x16)
10	BSCU25.V2-10	SCREW (3x10)
11	BSCU25.V2-11	SCREW (3x6)

NOTE: It is our policy to continually improve products and as such we reserve the right to alter data, specifications and component parts without prior notice.

IMPORTANT: No liability is accepted for incorrect use of product.

WARRANTY: Guarantee is 12 months from purchase date, proof of which will be required for any claim.

Sealey Group, Kempson Way, Suffolk Business Park, Bury St Edmunds, Suffolk. IP32 7AR



01284 757500



01284 703534



sales@sealey.co.uk



www.sealey.co.uk