



12A 9-CYCLE 12/24V COMPACT SMART CHARGER & MAINTAINER

MODEL NO: **AUTOCHARGE1200HF**

Thank you for purchasing a Sealey product. Manufactured to a high standard, this product will, if used according to these instructions, and properly maintained, give you years of trouble free performance.

IMPORTANT: PLEASE READ THESE INSTRUCTIONS CAREFULLY. NOTE THE SAFE OPERATIONAL REQUIREMENTS, WARNINGS & CAUTIONS. USE THE PRODUCT CORRECTLY AND WITH CARE FOR THE PURPOSE FOR WHICH IT IS INTENDED. FAILURE TO DO SO MAY CAUSE DAMAGE AND/OR PERSONAL INJURY AND WILL INVALIDATE THE WARRANTY. KEEP THESE INSTRUCTIONS SAFE FOR FUTURE USE.



Refer to instructions



Wear eye protection



Wear protective gloves



Electrical shock hazard



Warning: corrosive substance



Warning: risk of explosion



Keep away from sources of ignition

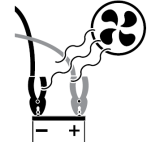

Use in well ventilated areas



Keep in dry area protect from rain

1. SAFETY

1.1. ELECTRICAL SAFETY

- WARNING!** It is the user's responsibility to check the following:
 - Check all electrical equipment and appliances to ensure that they are safe before using. Inspect power supply leads, plugs and all electrical connections for wear and damage. Sealey recommend that an RCD (Residual Current Device) is used with all electrical products.
 - If the charger is used in the course of business duties, it must be maintained in a safe condition and routinely PAT (Portable Appliance Test) tested.
 - Electrical safety information, it is important that the following information is read and understood.
 - ✓ Ensure that the insulation on all cables and on the appliance is safe before connecting it to the power supply.
 - ✓ Regularly inspect power supply cables and plugs for wear or damage and check all connections to ensure that they are secure.
 - ✓ Ensure that the voltage rating on the appliance suits the power supply to be used and that the plug is fitted with the correct fuse - see fuse rating in these instructions.
 - ✗ **DO NOT** pull or carry the appliance by the power cable.
 - ✗ **DO NOT** pull the plug from the socket by the cable. Remove the plug from the socket by maintaining a firm grip on the plug.
 - ✗ **DO NOT** use worn or damaged cables, plugs or connectors. Ensure that any faulty item is repaired or replaced immediately by a qualified electrician.
 - This product is fitted with a BS1363/A 13 Amp 3 pin plug.
 - ✓ If the cable or plug is damaged during use, switch the electricity supply off and remove from use.
 - ✓ Replace a damaged plug with a BS1363/A 13 Amp 3 pin plug. If in doubt contact a qualified electrician.
 - Class II products are wired with live (brown) and neutral (blue) only and are marked with the Class II symbol; 
 - A) Connect the BROWN live wire to the live terminal 'L'.
 - B) Connect the BLUE neutral wire to the neutral terminal 'N'.
 - C) After wiring, check that there are no bare wires and ensure that all wires have been correctly connected.
 - ✓ Ensure that the cable outer sheath extends inside the cable restraint and that the restraint is tight.
 - ✗ **DO NOT** connect either wire to the earth terminal.
 - Sealey recommend that repairs are carried out by a qualified electrician.

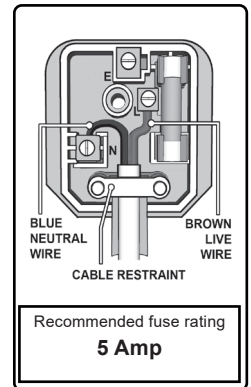

1.2. BATTERY CHARGER SAFETY

- ▲ **DANGER! BE AWARE, LEAD-ACID BATTERIES GENERATE EXPLOSIVE GASES DURING NORMAL BATTERY OPERATION. FOR THIS REASON, IT VERY IMPORTANT TO READ AND FOLLOW THESE INSTRUCTIONS CAREFULLY, EACH TIME YOU USE THE CHARGING EQUIPMENT.**
- ✓ Follow these instructions and those published by the battery and vehicle manufacturers, and the maker of any equipment you intend to use in the vicinity of the battery. Remember to review warning marks on all products and on engines.
- WARNING!** Modern vehicles contain extensive electronic systems. You are required to check with the vehicle Manufacturer, for any specific instructions regarding the use of this type of equipment on each vehicle. No liability will be accepted for damage / injury, where this product is not used in accordance with all instructions.

1.3. PERSONAL PRECAUTIONS

- ✓ Ensure there is another person within hearing range of your voice and close enough to come to your aid, should a problem arise when working near a lead-acid battery.
- ✓ Wear safety eye protection and protective clothing. Avoid touching eyes while working near battery.
- ✓ Have fresh water and soap nearby in case battery acid contacts skin, clothing or eyes.
- ✓ Wash immediately with soap and water if battery acid contacts skin or clothing. If acid enters eye, flush eye immediately with cool, clean running water for at least 15 minutes and seek immediate medical attention.

- ✓ Remove personal metallic items such as rings, bracelets, necklaces and watches. A lead-acid battery can produce a short-circuit current which is high enough to weld a ring or the like to metal, which would cause severe burns.
- ✓ Ensure hands, clothing (especially belts) are clear of fan blades and other moving or hot parts of engine, remove ties and contain long hair.
- ✗ **DO NOT** smoke or allow a spark or flame in the vicinity of battery or engine.

1.4. GENERAL SAFETY INSTRUCTIONS

- ✓ Familiarise yourself with the application and limitations of the charger as well as the potential hazards. Also refer to the vehicle manufacturer's hand book. **IF IN ANY DOUBT CONSULT A QUALIFIED ELECTRICIAN.**
- ✓ Ensure the charger is in good order and condition before use. If in any doubt **DO NOT** use the unit, contact your Sealey Stockist.
- ✓ Use the charger in the upright position only and ensure it is placed on a stable surface which will adequately support its weight.
- ✓ Ensure the charger is disconnected from the mains supply before attaching/detaching the power clamps to/from the battery.
- ✓ Keep tools and other items away from the engine and ensure you can see the battery and working parts of engine clearly.
- ✓ Ensure the output of the charger is the same voltage as the battery.
- ✓ Ensure that during charging, the charger is placed in a location where there is sufficient ventilation to prevent the build up of explosive gases from a lead acid battery, and **DO NOT** cover or obstruct the charger ventilation louvres.
- ✓ If battery has caps to access the battery fluid, remove the caps and check the fluid level before connecting the power clamps. If necessary top-up the battery with distilled water by referring to the battery manufacturer's instructions (Apply the personal safety precautions described in part 1.3).
- ✓ If the charger receives a sharp knock or blow the unit must be checked by a qualified service agent before using.
- ✓ If the battery terminals are corroded or dirty clean them before attaching the power clamps.
- ✓ Keep children and unauthorised persons away from the working area.
- ✗ **DO NOT** dis-assemble the charger for any reason. The charger must only be checked by qualified service personnel.
- ✗ **DO NOT** try to charge a non-rechargeable battery.
- ✗ **DO NOT** try to start engine when charger is connected to battery.
- ✗ **DO NOT** try to charge battery if battery fluid is frozen.
- ☐ **WARNING!** To prevent the risk of sparking, short circuit and possible explosion **DO NOT** drop metal tools in the battery area, or allow them to touch the battery terminals.
- ✗ **DO NOT** allow power clamps to touch each other or to make contact with any metallic part of the vehicle.
- ✗ **DO NOT** cross connect power leads from charger to battery. Ensure positive (+/RED) is to positive and negative (-/BLACK) is to negative.
- ✗ **DO NOT** pull the cables or clamps from the battery terminals.
- ✗ **DO NOT** use the charger outdoors, or in damp, or wet locations and **DO NOT** operate within the vicinity of flammable liquids or gases.
- ✗ **DO NOT** use charger inside vehicle or inside engine compartment.
- ✓ Ensure there is effective ventilation to prevent a build-up of explosive gases, and **DO NOT** cover or obstruct charger ventilation louvres.
- ✗ **DO NOT** use the charger for a task for which it is not designed.
- ☐ **WARNING! DO NOT** simultaneously charge batteries of different capacities or discharge levels.
- ☐ **WARNING!** If a fuse blows, ensure it is replaced with an identical fuse type and rating. Use only Sealey genuine parts.
- ✓ When not in use, store the charger carefully in a safe, dry, childproof location.
- ✓ **NOTE: This appliance can be used by children aged from 8 years and above and persons with reduced physical, sensory or mental capabilities or lack of experience and knowledge if they have been given supervision or instruction concerning use of the appliance in a safe way and understand the hazards involved. Children shall not play with the appliance. Cleaning and user maintenance shall not be made by children without supervision.**

2. INTRODUCTION

Dual voltage smart charger/maintainer ensures that the battery is kept fully charged and ready-to-use for extended periods of time. Clear, easy-to-read digital display indicates the percentage charging level and the output current of the charger. Heavy-duty case with simple controls. Charges, EFB & AGM/GEL (stop/start), Lithium and conventional lead acid batteries. Ideal for wide range of vehicles from cars, boats and motorcycles up to 24V commercial vehicles. Inbuilt reverse polarity protection.

3. SPECIFICATION

Model no:AUTOCHARGE1200HF
 Output: 12/24V
 Output: 12A @ 12V & 6A @ 24V
 Battery Range: 1.3-400Ah
 Cable Length: 1.4m (Including Clamps)
 Supply:230V
 IP Rating:IP20

4. OPERATION

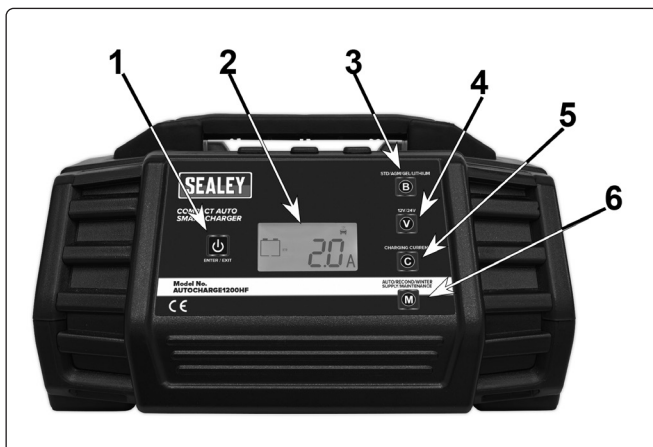

Item	Function
1	Enter / Exit button (start charging, stop charging)
2	LCD display (codes and icons)
3	Battery type selection (STD, AGM, GEL, Lithium)
4	Voltage selection button (12V, 24V)
5	Current selection (2A, 4A, 8A, 12A, auto selection)
6	Charging mode selection

4.1. MODE DESCRIPTION

Step 1 - Voltage Selection 'V'	Step 2 - Battery Selection	Step 3 - Charging Mode Selection (A)	Step 4 - Start charging	Charging status	Applicable battery capacity (Ah)
12V	STD AGM GEL	2A	ENTER / EXIT	12V 2A Charging mode	1.3 - 60Ah
		4A		12V 4A Charging mode	2.6 - 120Ah
		8A		12V 8A Charging mode	4 - 250Ah
		12A		12V 12A Charging mode	5 - 400Ah
		AUTO		12V Auto mode	/
		RECOND		12V Recon mode	/
		WINTER		12V Winter mode	/
		SUPPLY		12V Supply mode	/
		MAINTENANCE		12V Maintain mode	/
		LITHIUM		4A	12V 4A Charging mode
	AUTO			12V Auto mode	/
	MAINTENANCE			12V Maintain mode	/
	24V	GEL AGM STD		2A	24V 2A Charging mode
4A			24V 4A Charging mode	2.6-120Ah	
6A			24V 6A Charging mode	3.3-200Ah	
AUTO			24V Auto mode		
WINTER			24V Winter mode	/	
MAINTENANCE			24V Maintain mode	/	

4.2. 9 Stage charging.

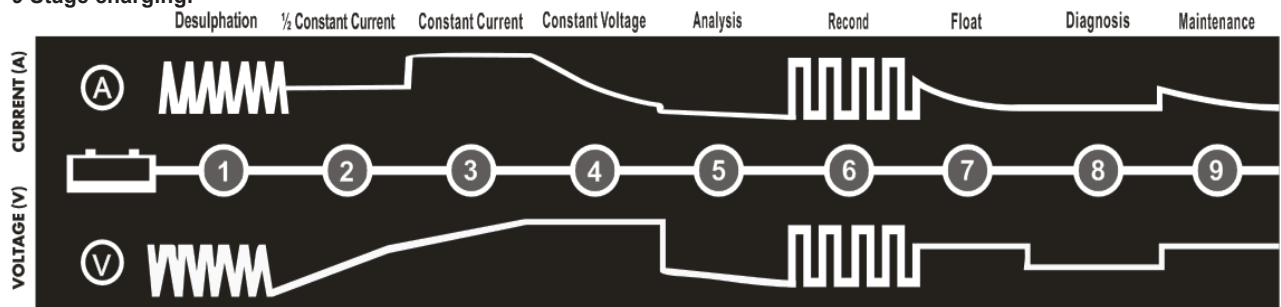

- Stage 1: Desulphation: Pulses of current and voltage.
- Stage 2: Battery charge to 25% capacity using 50% constant current.
- Stage 3: Battery charge to 50% capacity using max. current.
- Stage 4: Battery charge to 75% capacity using constant voltage.
- Stage 5: Analysis: Analysing power capacity.
- Stage 6: Recond: If power capacity is low use Recond to attempt recovery.
- Stage 7: Battery charge to 100% capacity using constant voltage.
- Stage 8: Diagnosis: Check battery for 100% charged.
- Stage 9: Maintenance: Battery fully charged.

4.3. CONNECTING TO THE BATTERY

NOTE: the charger should be connected to the battery before connecting to mains supply.

- 4.3.1. The output cable from the charger terminates in a polarity conscious socket into which the two alternative leads can be connected.
- 4.3.2. One lead set has two colour coded battery clamps which can be quickly attached to and detached from the battery posts. The second lead is for semi permanent connection to the battery via eyelets.

4.4. CHARGING A NEGATIVE EARTHED BATTERY

- 4.4.1. Ensure that the black clamp on the clamp lead is not touching the battery or the fuel line.
- 4.4.2. Connect the positive (+) red clamp to the positive (+) battery post and connect the negative (-) black clamp to the negative (-) battery post or vehicle chassis.

4.5. CHARGING A POSITIVE EARTHED BATTERY

- 4.5.1. Ensure that the red clamp on the clamp lead is not touching the battery or the fuel line.
- 4.5.2. Connect the negative (-) black clamp to the negative (-) battery post and connect the positive (+) red clamp to the positive (+) battery post or vehicle chassis.

4.6. BATTERY NOT CONNECTED TO A VEHICLE

- 4.6.1. Connect the (+) red clamp to the positive (+) battery post and connect the (-) black clamp to the negative (-) battery post.

4.7. PERMANENT CONNECTION TO VEHICLE USING EYELET LEAD









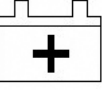

- 4.7.1. Connect the eyelet on the red (+) wire to the positive (+) battery terminal and connect the eyelet on the black (-) wire to the negative (-) battery terminal.

4.8. CHARGING MODE SELECTION (SEE CHART SECTION 4.1)

- 4.8.1. Choice of charging mode depends on battery rated voltage and battery type.
- 4.8.2. When charging mode is selected, enter charging by pressing Enter/Exit button.

4.8.3. When charging is complete disconnect the unit from the mains power supply before disconnecting from the battery.



4.9. LCD DISPLAY MODES

	Flickering symbol. No connection / poor connection to battery.
	Inverse connection to battery. Reconnect black to negative pole, red to positive pole.
	Battery capacity percentage.
	Reconditioning mode.
	Winter mode.
	Maintain mode.
	Supply mode
	24V Charging mode.
	12V Charging mode.
	Battery type switch mode.
	Function selection.

4.10. LCD DISPLAYED CODES.

CODE	MODE	FAULT CODES	REASON
AUT	AUTO MODE	F01	SHORT CIRCUIT PROTECTION
PUL	PULSE MODE	F02	OVER-VOLTAGE PROTECTION
REC	RECOND MODE	F03	OVER-CURRENT PROTECTION
FUL	FULLY CHARGED	F04	OVER -TEMPERATURE PROTECTION
SUP	SUPPLY MODE	F05	OVER-TIME CHARGING
CHE	ANALYSIS MODE	F06	REVERSE CONNECTION PROTECTION

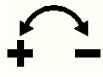
5. TROUBLESHOOTING

Symptom	Solution
No reaction when powered on.	Check mains connection and power supply. Return to Sealey stockist.
 Icon permanently displayed.	Incorrect polarity - swap battery connections.
 Flashing icon	Check connections to battery. Check for broken cables. Return to Sealey stockist.
Mode cannot be selected.	Mechanical failure of switch. Improper operation of switch. NOTE: Mode can only be changed when battery is not connected.

6. MAINTENANCE

- **WARNING: Disconnect from power supply before performing any maintenance.**
- 6.1. Cleaning and user maintenance should be carried out by competent persons.
- 6.2. After use and before performing maintenance, unplug and disconnect the battery charger.
- 6.3. Use a dry cloth to wipe all battery corrosion and other dirt or oil from the battery connectors, cords, and the charger case.
- 6.4. Ensure that all of the charger components are in place and in good working condition, for example, the plastic boots on the battery clips.
- 6.5. Servicing does not require opening the unit, as there are no serviceable parts.
- 6.6. All other servicing should be performed by qualified service personnel.
- 6.7. If the mains cable is damaged, **DO NOT** use until repaired.
- 6.8. Store the charger unplugged. The cord will still conduct electricity until it is unplugged from the mains.
- 6.9. Store inside, in a cool, dry place.
- × **DO NOT** store the connectors clipped together, on or around metal, or clipped to cables. If the charger is moved around the workshop or transported to another location, take care to avoid/prevent damage to the cables, connectors and charger. Failure to do so could result in personal injury or property damage.



WEEE REGULATIONS

Dispose of this product at the end of its working life in compliance with the EU Directive on Waste Electrical and Electronic Equipment (WEEE). When the product is no longer required, it must be disposed of in an environmentally protective way. Contact your local solid waste authority for recycling information.



ENVIRONMENT PROTECTION

Recycle unwanted materials instead of disposing of them as waste. All tools, accessories and packaging should be sorted, taken to a recycling centre and disposed of in a manner which is compatible with the environment. When the product becomes completely unserviceable and requires disposal, drain any fluids (if applicable) into approved containers and dispose of the product and fluids according to local regulations.

Note: It is our policy to continually improve products and as such we reserve the right to alter data, specifications and component parts without prior notice.

Important: No Liability is accepted for incorrect use of this product.

Warranty: Guarantee is 12 months from purchase date, proof of which is required for any claim.

Sealey Group, Kempson Way, Suffolk Business Park, Bury St Edmunds, Suffolk. IP32 7AR



01284 757500



01284 703534



sales@sealey.co.uk



www.sealey.co.uk