



MODULAR RACKING BASE UNIT 2 SHELVES 580MM

MODEL NO: **APMRB1**

Thank you for purchasing a Sealey product. Manufactured to a high standard, this product will, if used according to these instructions, and properly maintained, give you years of trouble free performance.

IMPORTANT: PLEASE READ THESE INSTRUCTIONS CAREFULLY. NOTE THE SAFE OPERATIONAL REQUIREMENTS, WARNINGS & CAUTIONS. USE THE PRODUCT CORRECTLY AND WITH CARE FOR THE PURPOSE FOR WHICH IT IS INTENDED. FAILURE TO DO SO MAY CAUSE DAMAGE AND/OR PERSONAL INJURY AND WILL INVALIDATE THE WARRANTY. KEEP THESE INSTRUCTIONS SAFE FOR FUTURE USE.



Refer to instructions



Wear eye protection

1. SAFETY

- WARNING!** Ensure Health & Safety, local authority, and general workshop practice regulations are adhered to when using this product.
- Locate product in a suitable working area.
- Keep the work area clean, uncluttered and ensure there is adequate lighting.
- WARNING!** Use product on level and solid ground, preferably concrete. Avoid tarmac since the product may sink into the surface.
- Keep the product clean and tidy in accordance with good workshop practice.
- Keep children and unauthorised persons away from the working area.
- DO NOT** use the product for any purpose other than that for which it is designed.
- DO NOT** exceed maximum capacity of product.
- DO NOT** undertake work on the product without the work piece being adequately secured. Use clamps or a vice (not included) to secure the work piece. Available from your Sealey stockist.
- DO NOT** use the product out of doors.
- DO NOT** get the product wet or use in damp or wet locations or areas where there is condensation.
- DO NOT** clean the product with any solvents which may damage the paint surface or the protective coating.

2. INTRODUCTION

The Sealey modular racking system is finished with a heavy-duty textured powder coat to prevent against rusting. Simply choose your base, middle and top units and push together using nylon connectors to create versatile storage for the workshop, garage, home or office. All drawers have ball-bearing drawer slides for smooth operation and cupboard doors are fitted with spring loaded hinges allowing them to be fitted the side that suits your environment. Buy individually (see specific model number for full specs) or as one of our pre-created combo's.

3. SPECIFICATION

Model no:	APMRB1
Nett Weight:	6.3kg
Overall Size (W x D x H):	580 x 340 x 544mm
Shelves:	2

4. CONTENTS

Item	Part	Description
1	APMRB1-01	Left Side, Front Upright
2	APMRB1-02	Right Side, Front Upright
3	APMRB1-03	Rear Upright
4	APMRB1-04	Top/Bottom Panel
5	APMRB1-05	Bottom Panel
6	APMRB1-06	Skirting Board
7	APMRB1-07	Plastic End Plug
8	MSP612.S	Machine Screw Pan Head Phillips M6 X 12mm
11	APMRB1-11	Plastic Connector
12	MSP410.S	Machine Screw Pan Head Phillips M4 X 10mm
--	APMRB1-09	Self-Tapping Screw ST4.8*30 (not shown)
--	APMRB1-10	Expansion Plug M8*40 (not shown)

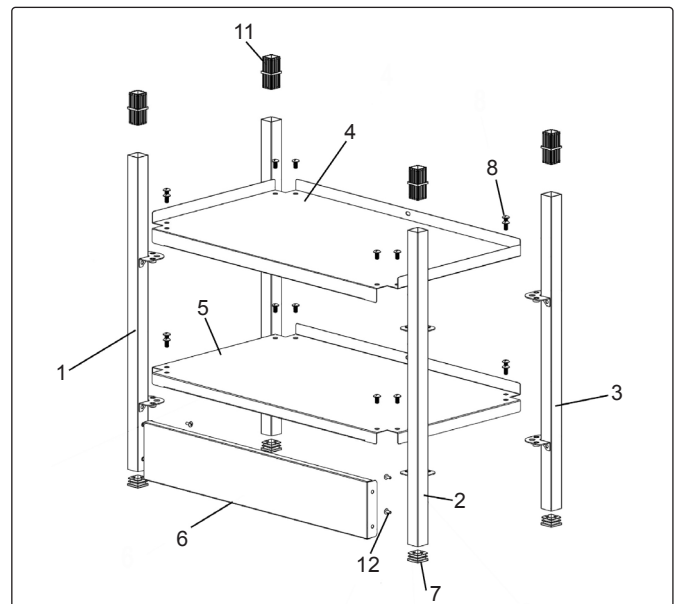

5. ASSEMBLY

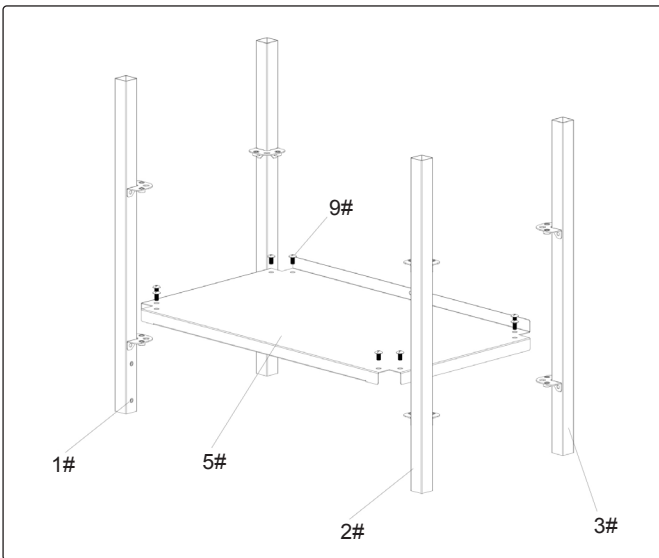

Step 1. Assemble the uprights in order of illustration, attach bottom panel with screws M6*12 as shown. **Note:** The holes in 1# & 2# are for the skirting board to screw into.

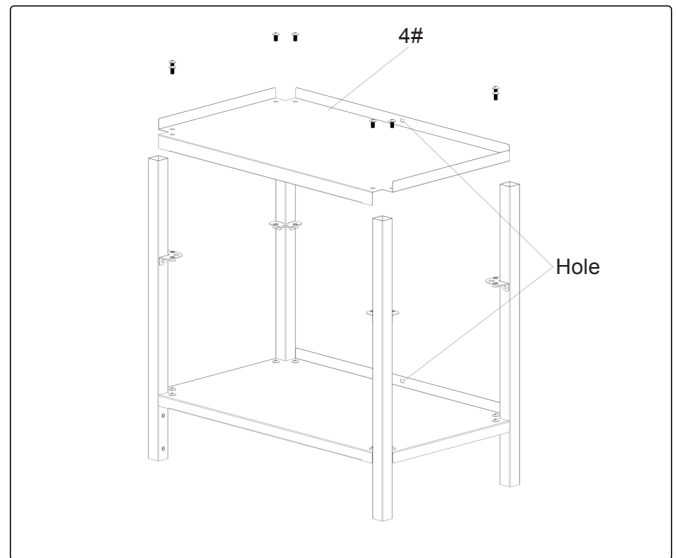

Step 2. Assemble the top panel to the uprights with screws M6*12 as shown. **Note:** The top panel position.

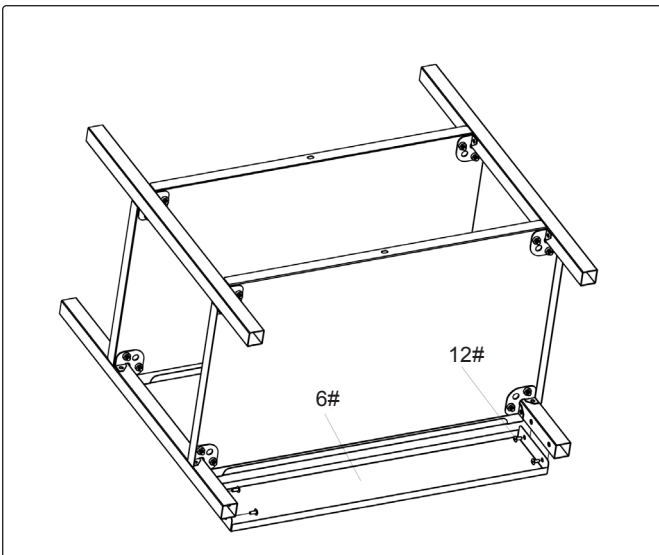

Step 3. Assemble the skirting board to the uprights using screws M4*10.

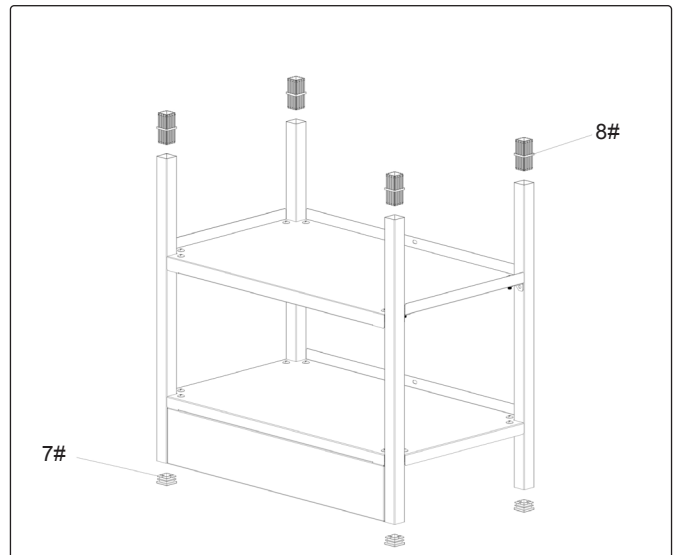

Step 4. Insert the plastic connectors into the uprights.

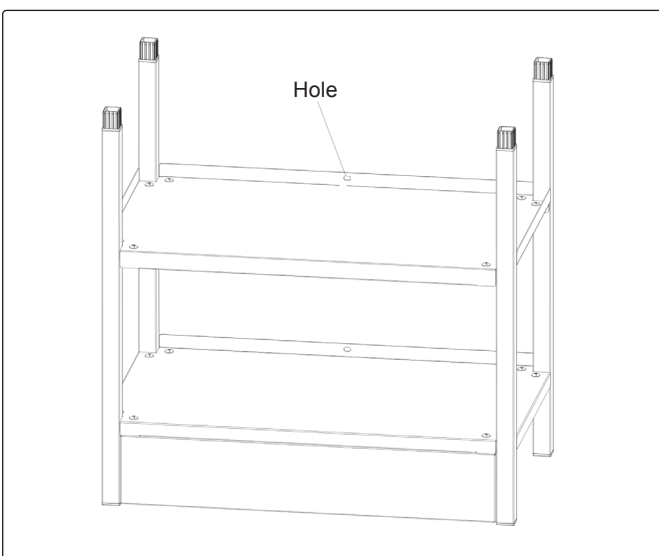

Step 5. To fix to the wall. Mark the wall out before drilling the hole using the back of the top panel.

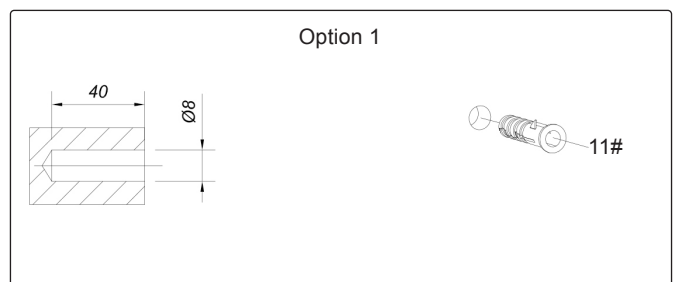

Step 6. To fix the cabinet on the wall. Mark the wall out before drilling the hole, after the wall has been marked out drill a hole the size required see above illustration, insert the wall plug 8*40 into the drilled hole.

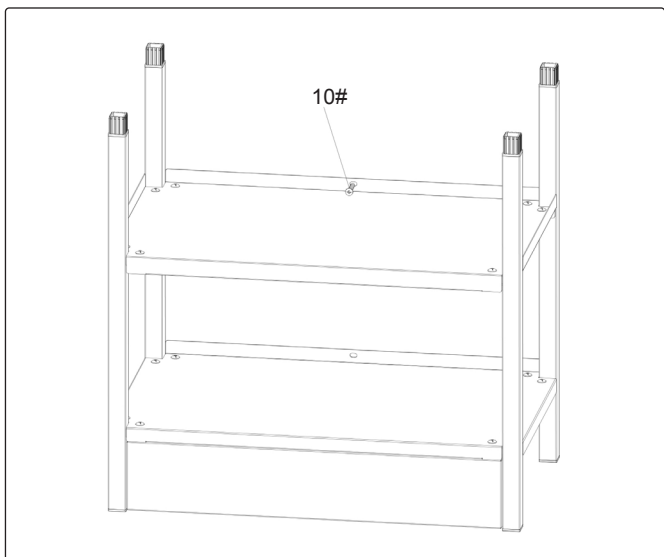

Step 7. Fix cabinet to the wall using self-tapping screw ST4.8*30.

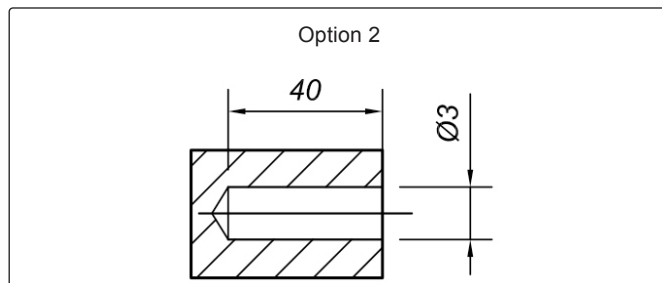

Step 8. To fix the cabinet on to a wooden wall. Mark the wall before drilling. After the wall has been marked, drill a hole the correct size. See above illustration for size guide.

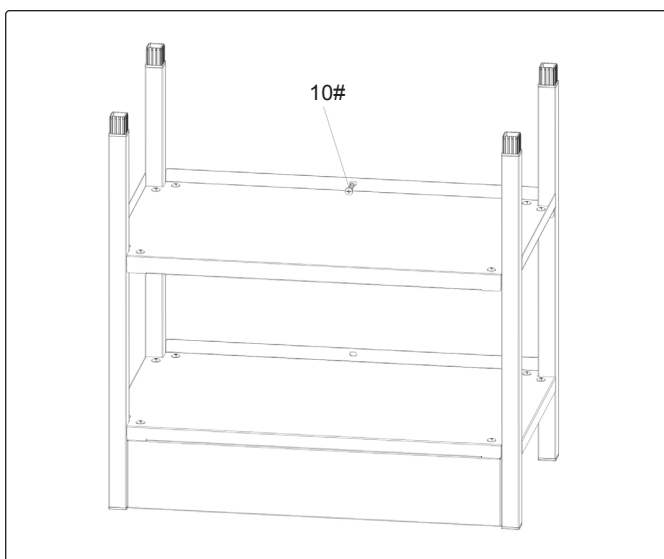

Step 9. Fix the cabinet to the wooden wall with the self-tapping screw ST4.8*30, no wall plug is required.

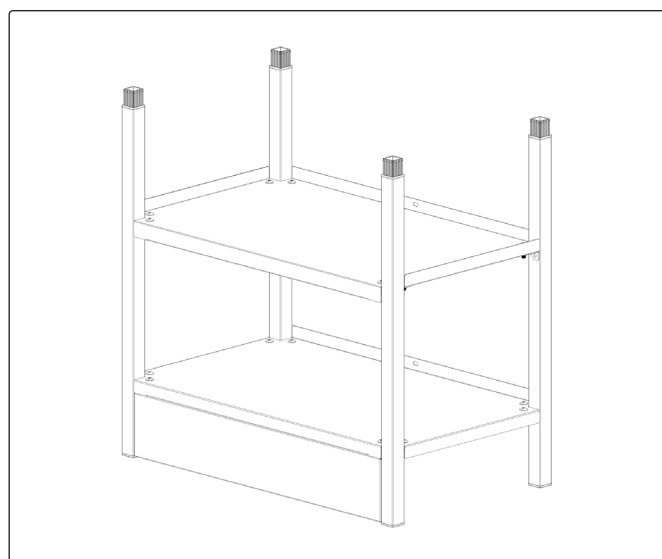

Step 10. Assembly completed.



ENVIRONMENT PROTECTION

Recycle unwanted materials instead of disposing of them as waste. All tools, accessories and packaging should be sorted, taken to a recycling centre and disposed of in a manner which is compatible with the environment. When the product becomes completely unserviceable and requires disposal, drain any fluids (if applicable) into approved containers and dispose of the product and fluids according to local regulations.



NOTE: It is our policy to continually improve products and as such we reserve the right to alter data, specifications and component parts without prior notice.

IMPORTANT: No Liability is accepted for incorrect use of this product.

WARRANTY: Guarantee is 12 months from purchase date, proof of which is required for any claim.

Sealey Group, Kempson Way, Suffolk Business Park, Bury St Edmunds, Suffolk. IP32 7AR



01284 757500



sales@sealey.co.uk



www.sealey.co.uk