



OIL DISPENSING SYSTEM AIR OPERATED

MODEL NO: **AK4563D**

Thank you for purchasing a Sealey product. Manufactured to a high standard, this product will, if used according to these instructions, and properly maintained, give you years of trouble free performance.

IMPORTANT: PLEASE READ THESE INSTRUCTIONS CAREFULLY. NOTE THE SAFE OPERATIONAL REQUIREMENTS, WARNINGS & CAUTIONS. USE THE PRODUCT CORRECTLY AND WITH CARE FOR THE PURPOSE FOR WHICH IT IS INTENDED. FAILURE TO DO SO MAY CAUSE DAMAGE AND/OR PERSONAL INJURY AND WILL INVALIDATE THE WARRANTY. KEEP THESE INSTRUCTIONS SAFE FOR FUTURE USE.



Refer to instructions



Wear eye protection



Wear protective gloves



Wear safety footwear



Wear protective clothing

1. SAFETY

- ❑ **WARNING!** Ensure health & safety, local authority, and general workshop practice regulations are strictly adhered to when using this equipment.
- ✓ Familiarise yourself with product application and limitations, as well as the specific potential hazards peculiar to this product.
- ✓ Maintain the pump station in good condition (use an authorised service agent).
- ✓ Replace or repair damaged parts. Use genuine parts only. Non authorised parts will invalidate the warranty.
- ✓ Use only to pump lubricants up to SAE 150 viscosity.
- ✓ Ensure safety eye protection, oil resistant gloves and protective clothing are worn when using this product.
- ✓ Keep the work area clean, uncluttered and ensure there is adequate lighting.
- ✓ Maintain correct balance and footing. Ensure the floor is not slippery and wear non slip shoes.
- ✓ Keep children and unauthorised persons away from the working area.
- ✓ After use, drain any fluids from the equipment before storage.
- ✓ Dispose of waste liquids in accordance with local authority regulations.
- ✓ Disconnect air pressure from equipment when not in use.
- ✗ **DO NOT** exceed the maximum air pressure of 115psi.
- ✗ **DO NOT** point the nozzle at people or animals.
- ✗ **DO NOT** use the equipment near open flames.
- ✗ **DO NOT** smoke whilst using this equipment.
- ✗ **DO NOT** use to extract corrosive fluids.
- ✗ **DO NOT** dismantle, tamper with or adapt the pump for any purpose other than for which it is designed.
- ✗ **DO NOT** use the unit if it has been dropped or mishandled, check the unit to ensure there is no damage.
- ✗ **DO NOT** leave the trolley on a slope, or traverse slopes, which may cause the unit to topple.
- ✓ The unit must be stored on a level surface.
- ✓ Keep the pump clean and store in a safe dry, childproof location.
- ❑ **WARNING! DO NOT** allow uncontrolled discharge of fluids thus polluting the environment. All liquids must be disposed of according to local authority regulations.

2. INTRODUCTION

Mobile oil dispensing unit with air operated 3:1 double acting pump for barrel or tanks with 2" BSP fittings. Pump is supplied with air management system and connected to a 730mm rigid suction probe with non-return valve. Features 4mtr hose and digital oil meter Model No. AK4565D. Suitable for use with engine, hydraulic, synthetic, gear and transmission oils up to SAE150.

3. SPECIFICATION

Model No:.....AK4563D
 Maximum Air Pressure:.....115psi
 Maximum Flow Rate:.....12ltr/min
 Maximum Output Pressure:.....350psi
 Maximum Trolley Capacity:.....50kg
 Maximum Viscosity:.....SAE150
 Nett Weight:.....18.45Kg
 Outlet Size:.....1/2" BSP
 Pump Ratio:.....3:1
 Recommended Air Pressure:.....70psi
 Digital Hose End Meter
 Model.....AK4565D
 Accuracy:.....+/- 0.5%
 Inlet:.....1/2" BSP
 Battery:.....Lithium CR2 3V 1400mAh



fig. 1

4. ASSEMBLY

4.1. TROLLEY ASSEMBLY (FIG.2).

- 4.1.1. Attach the two castor wheels (17) to the base plate (2) using washers (19 & 20) and nuts (18).
- 4.1.2. Turn the base plate upside down and attach the axle (12) to the base plate using hex bolt (8) and then slide washer (13) on to the axle slide wheel (16) onto the axle and secure using washer (15) and hex bolt (14). Repeat for the other side and then turn the base plate over so that it is now supported on its wheels.
- 4.1.3. Slide the adjustable accessory support (6) onto the handle (3) and attach them using knob (9).
- 4.1.4. Slide the accessory support pole (7) through section (6) and locate using knob (9), insert stopper (11) into the end of the accessory support pole. Screw pump securing knob (10) into the end of the support pole.
- 4.1.5. Slide the drum holder support (5) onto the handle and secure using knob (9).
- 4.1.6. Slide the handle assembly into the base plate until it bottoms out on the stops and secure with the hex grub screw (1).

4.2. PUMP AND AIR REGULATOR/LUBRICATOR ASSEMBLY (FIG.3).

- 3.2.1. Apply a small amount of liquid thread sealant onto the threads of the air inlet of the pump and attach the air regulator/lubricator (fig.3).
 - ❑ **WARNING! DO NOT** allow thread sealant to enter the pump.
 - 4.2.1. Attach the outlet pipe to the male outlet thread on the pump and attach the male threaded end of the pipe to the retractable hose reel.
 - 4.2.2. Attach the outlet of the retractable hose reel to the Digital Hose End Meter.
 - 4.2.3. Attach the nozzle valve pipe assembly to the outlet of the Digital Hose End Meter.
 - ❑ **WARNING! DO NOT** over tighten the swivel connections.
 - 4.2.4. Slide the locking nut, locking ring and the barrel nut onto the pick up probe of the pump (fig.4), screw the locking nut onto the barrel nut to lock the assembly to the pick up probe.
 - 4.2.5. Insert the pump assembly into the support brackets on the trolley and hang the meter onto the accessory support bracket.
- ### 4.3. PRE-OPERATION.
- 4.3.1. Lift up the knob (fig.3A) on the air regulator and ensure that it is wound fully anti-clockwise.
 - 4.3.2. Remove the filler plug (fig.3B) from the lubricator and fill the lubricator with a quality air tool oil (Sealey ATO1000S), refit the filler plug.
 - 4.3.3. The lubricator feed is set when the unit is running, adjust the feed knob (fig.3C) the drip rate can be seen through the sight glass of the dome. The rate of oil feed will automatically increase or decrease inline with the air flow.

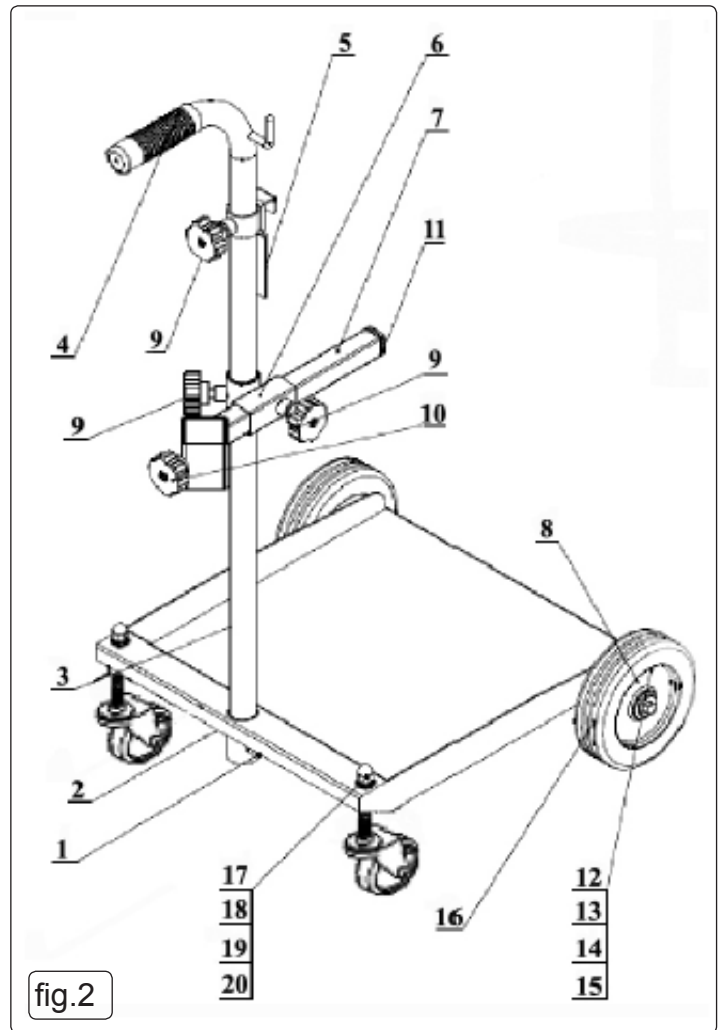

fig.2

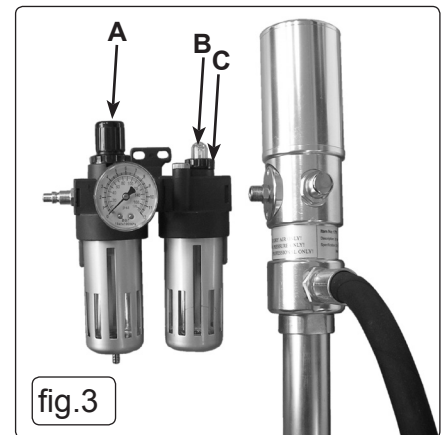

fig.3

5. OPERATION

- 5.1. Place a 25ltr drum onto the trolley, locate the drum using the drum holder support (fig.2.5) and secure with knob (fig.2.9).
- 5.2. **INSTALLING THE PUMP.**
 - 5.2.1. Remove the bung from the 2" BSP opening of the drum.
 - 5.2.2. Slacken off the locking nut on the pump probe and insert the pump into the drum until the probe bottoms out, tighten the barrel nut and then tighten the locking nut to fix the pump to the drum.
- 5.3. **SETTING UP THE PUMP.**
 - 5.3.1. Ensure that the air regulator valve is fully wound anti-clockwise and then connect the air supply onto the quick release connector on the air regulator.
 - 5.3.2. Lift the knob on the regulator and slowly turn clockwise until the recommended operating pressure of 70psi is reached, push down on the regulator knob to lock the position.

NOTE: Check the system for leaks, should an air leak be discovered, release the pressure, disconnect the air line and repair/replace the joint or seal before continuing.

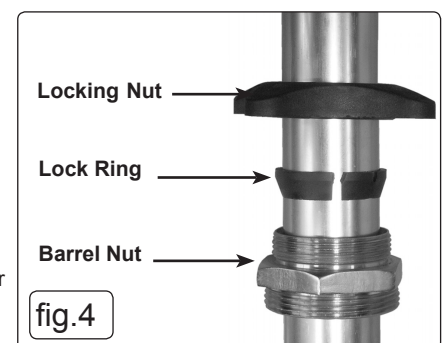
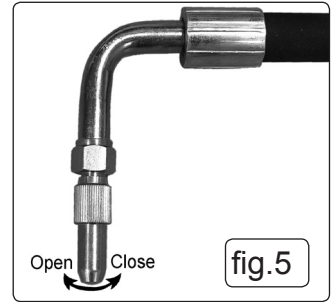

fig.4

5.4. OPERATING THE GUN

- **WARNING!** Ensure that the trigger is not depressed before opening the nozzle valve.
- 5.4.1. Press the Reset button for 1 sec to zero the display.
- 5.4.2. With the nozzle pointing into the receiving container, open the nozzle valve as shown in fig.5.
- 5.4.3. Depress the trigger and dispense the liquid the amount dispensed as shown on the display (fig.6.4).
- 5.4.4. Release trigger and close the nozzle valve.



5.5. LCD INTERFACE USAGE

5.5.1. User Buttons (fig.6)

1. LCD displays delivery volume and totals
2. Units: L, GAL, PT, QT
3. Two decimal place values
4. Low battery indicator
5. MOVE and RESET buttons

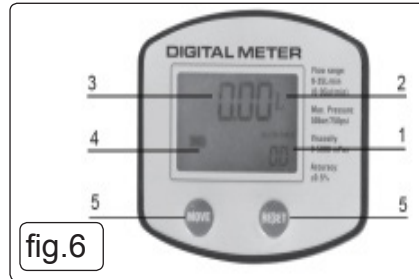

5.5.2. Display key (fig.7)

1. Volume since last RESET
2. Battery state
3. Calibration mode indicator
4. Reset to zero indicator
5. Total register
6. Flow rate mode
7. Units (Lts/gall/pint/quart)

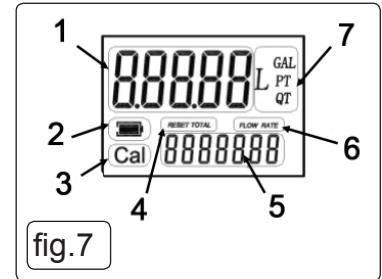

5.5.3. MOVE / RESET Usage (fig.6.5)

- MOVE key enters 'calibration' mode
- RESET key for register and total
- Both keys pressed enters 'configuration' mode

5.5.4. To RESET current total (fig.7)

- From standby press RESET
- All segments light up
- Current total resets to 0.00

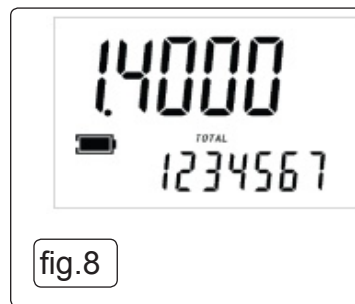

5.5.5. To display correction factor and Total (fig.8)

- Hold MOVE and RESET for 3 seconds
- Value "1.4000" is correction factor.
- "1234567" overall total

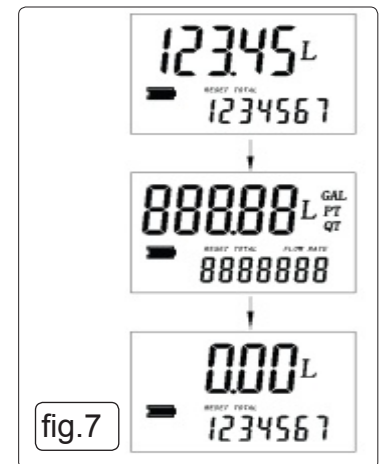

5.5.6. To change Units (fig.9)

- Hold MOVE and RESET for several seconds
- Area 2 in fig.6 shows units
- Press RESET to change units
- Press and hold MOVE to confirm choice

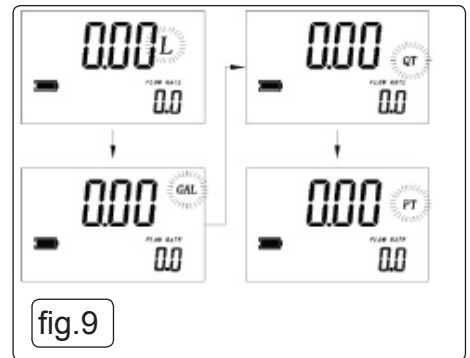

5.6. DETERMINING THE CORRECTION FACTOR

- 5.6.1. Dispense at least 1 litre of liquid into a calibrated container.
- 5.6.2. Record the quantity of liquid in the container and record the quantity of liquid dispensed as indicated on the meter display. Press the Move + Reset buttons (fig.6.5 and fig.6.5) simultaneously to display the current correction factor.

Qty Dispensed x **Current Correction Factor** = **New Correction Factor.**
Qty Indicated

5.7. ALTERING CORRECTION FACTOR DIRECTLY.

- 5.8. Wait for meter to go to standby (fig.7).
- 5.8.1. Reset total (5.5.4) fig.9 to zero.
- 5.8.2. Press and hold MOVE key until all digits illuminate and display shows 'Cal' (fig.9).
- 5.8.3. Press RESET to set digit values (from right to left) (fig.11).
- 5.8.4. Once value is correct hold down MOVE key until Cal mode quits.

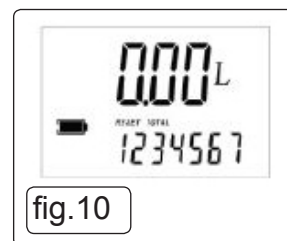

5.9. ALTERING CORRECTION FACTOR INDIRECTLY

- 5.9.1. Wait for meter to go to standby (fig.11).
- 5.9.2. Reset the total (5.5.3) fig.10 to zero.
- 5.9.3. Dispense into measuring container (minimum 5 litres) and record.
- 5.9.4. If displayed value does not match actual measured value press and hold MOVE key until each digit reads as per the measured value. Press MOVE key to visit each digit in turn.
- 5.9.5. Once value is correct (i.e. matches measured value) press and hold MOVE key until Cal mode quits (fig.10).

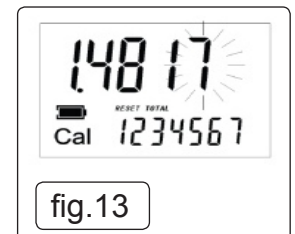
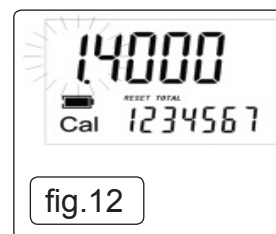

6. MAINTENANCE

6.1. CHANGING THE DIGITAL METER BATTERY

- 6.1.1. Remove the rubber protective cover from the meter.
- 6.1.2. Remove the screw and cover from the side of the meter.
- 6.1.3. Remove and replace battery (fig.15).
- 6.1.4. Replace cover and secure with screw.
- 6.1.5. Replace the protective rubber cover.
- 6.2. Before every use visually check the supply hose for damage and check all joints for leaks, any damaged component must be replaced or leaks repaired before using.
- 6.3. Check the nozzle valve for leaks, if it does not seal, replace before using.
- 6.4. Drain air regulator water trap daily.
- 6.5. Top up lubricator as required, using a quality air tool oil.
- 6.6. To change the silencer, remove the circlip (fig.14) and remove the old silencer, place a new silencer into the recess and refit the circlip.

NOTE: For any other maintenance and repairs the unit should be returned to your Sealey stockist.

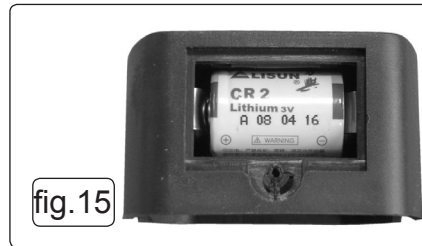
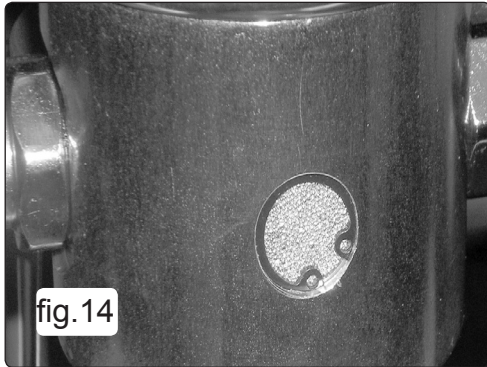

ENVIRONMENT PROTECTION

Recycle unwanted materials instead of disposing of them as waste. All tools, accessories and packaging should be sorted, taken to a recycling centre and disposed of in a manner which is compatible with the environment. When the product becomes completely unserviceable and requires disposal, drain any fluids (if applicable) into approved containers and dispose of the product and fluids according to local regulations.



WEEE REGULATIONS

Dispose of this product at the end of its working life in compliance with the EU Directive on Waste Electrical and Electronic Equipment (WEEE). When the product is no longer required, it must be disposed of in an environmentally protective way. Contact your local solid waste authority for recycling information.



BATTERY REMOVAL SEE SECTION 6.1

Under the Waste Batteries and Accumulators Regulations 2009, Jack Sealey Ltd are required to inform potential purchasers of products containing batteries (as defined within these regulations), that they are registered with Valpak's registered compliance scheme. Jack Sealey Ltd Batteries Producer Registration Number (BPRN) is BPRN00705.

Note: It is our policy to continually improve products and as such we reserve the right to alter data, specifications and component parts without prior notice.

Important: No Liability is accepted for incorrect use of this product.

Warranty: Guarantee is 12 months from purchase date, proof of which is required for any claim.

Sealey Group, Kempson Way, Suffolk Business Park, Bury St Edmunds, Suffolk. IP32 7AR



01284 757500



01284 703534



sales@sealey.co.uk



www.sealey.co.uk