



3 TONNE STANDARD CHASSIS TROLLEY JACK WITH AXLE STANDS (PAIR) MODEL NO: 3010CX.V3

Thank you for purchasing a Sealey product. Manufactured to a high standard, this product will, if used according to these instructions, and properly maintained, give you years of trouble free performance.

IMPORTANT: PLEASE READ THESE INSTRUCTIONS CAREFULLY. NOTE THE SAFE OPERATIONAL REQUIREMENTS, WARNINGS & CAUTIONS. USE THE PRODUCT CORRECTLY AND WITH CARE FOR THE PURPOSE FOR WHICH IT IS INTENDED. FAILURE TO DO SO MAY CAUSE DAMAGE AND/OR PERSONAL INJURY AND WILL INVALIDATE THE WARRANTY. KEEP THESE INSTRUCTIONS SAFE FOR FUTURE USE.



Refer to instructions



Wear protective footwear

1. SAFETY

1.1. JACK

- ✓ Ensure the jack is in sound condition and good working order. Take action for immediate repair or replacement of damaged parts. Use genuine parts only. The use of improper parts may be dangerous and will invalidate the warranty.
- ✓ Locate the jack in a suitable, well lit working area. Keep working area clean and tidy and free from unrelated materials.
- ✓ Use jack on level/solid ground, preferably concrete. Avoid tarmac as jack may sink in.
- ✓ Place wedges under wheels of vehicle, but ensure the jack wheels are free to move and that there are no obstructions.
- ✓ Ensure the vehicle handbrake is engaged, engine is switched off and transmission is in gear (or "PARK" if automatic).
- ✓ Ensure minimum distance of 0.5m between vehicle and static objects such as doors, walls, etc., to allow for vehicle tilting.
- ✓ Ensure there are no passengers in the vehicle and that all non-essential persons keep a safe distance whilst the jack is in use.
- ✓ Place jack under lifting points recommended by vehicle manufacturer (see vehicle hand book). Ensure lifting point is stable and centred on saddle.
- ▲ **DANGER:** Use the jack for lifting only, NOT for supporting the lifted load.
- ✓ Use suitable capacity axle stands under the vehicle before proceeding with any task.
- ✓ Ensure there are no persons or obstructions beneath the vehicle before lowering.
- ✗ **DO NOT** operate the jack if damaged.
- ✗ **DO NOT** work under the vehicle until axle stands have been correctly positioned.
- ✗ **DO NOT** exceed the rated capacity of the jack (3tonne/3000kg). When lifting a load of maximum capacity or close to it, it is recommended that the effort be reduced by the use of assistance during this operation.
- ✗ **DO NOT** adjust the safety overload valve.
- ✗ **DO NOT** jack vehicle if there is a risk of spillage of fuel, battery acid, or other dangerous substances.
- ✗ **DO NOT** allow the vehicle to move while supported by the jack, or use the jack to move the vehicle.
- ✗ **DO NOT** top up hydraulic system with brake fluid. Use hydraulic jack oil only and use a qualified person to maintain jack hydraulic system.
- ✗ **DO NOT** allow untrained persons to operate the jack.
- ✗ **DO NOT** use jack for purposes other than which it is designed.
- ✗ **DO NOT** allow persons to ride on the jack.
- ✗ When not in use store jack, fully lowered, in a safe, dry, childproof area.

1.2. AXLE STANDS

- **WARNING! DO NOT overload Axle stands beyond rated capacity. Overloading can cause damage to, or failure of, the Axle stands. Position load on centre of crutch/saddle only. Always use stands in pairs on hard level surface capable of sustaining the load. Use of stands on other than hard level surfaces can result in load instability and possible loss of load. DO NOT use on tarmac. Failure to follow these instructions may result in damage to axle stands, loss of load resulting in property damage, serious personal injury or loss of life.**
- ▲ **DANGER! Great care must be taken to ensure you lower the vehicle (or other load) slowly and carefully onto the centres of the crutch/saddle of the axle stands.**
- ✓ Use only as specified by the manufacturer.
- ✓ Ensure the load does not exceed the maximum capacity as marked on the axle stand, per pair.
- ✓ Use no more than a single pair of stands either on the front, rear or one side of the vehicle. Use in pairs.
- ✓ No alterations or modifications shall be made to this product.
- ✓ Use on a hard, level surface, e.g. concrete. Do not use on uneven ground or tarmac.
- ✓ Securely chock wheels in contact with the ground. Before jacking and placing the stands, apply vehicle handbrake, and place in gear. (For automatics select the 'Park' mode).

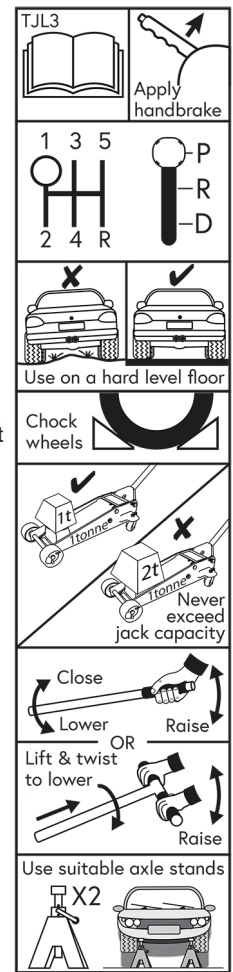

- ✓ Make sure that each stand is securely located under a strong point on the vehicle; consult the vehicle manufacturer's handbook for guidance. Ensure that height adjust locking mechanism is fully located before applying any load to the axle stand.
- ✓ Ensure that the load is located centrally on the saddle, and that the weight is directed through the vertical axis of the stand.
- ✓ Exercise extra care when using with a three wheeled vehicle or a trailer. Refer to vehicle manufacturer's instructions.
- ✓ Once vehicle is supported, ensure that the vehicle and stands are stable before starting work. Ensure that it is not possible for the vehicle to move before commencing any work.
- ✓ Inspect stands before each use.
- ✗ **DO NOT** use if they show signs of damage.
- ✗ **DO NOT** use if it is suspected that they have been overloaded.
- ✓ Before commencing any work or going beneath the vehicle, undertake a risk assessment. Ensure that a responsible person is aware of the work about to be undertaken.
- ✓ Replace any labels on the axle stand should they become unreadable. This applies in particular to any warning or operation instruction labels. If replacement labels are required, contact your Sealey stockist.
- ✗ **DO NOT** use axle stands on the highway, or anywhere else if it is deemed to be unsafe.
- ✗ **DO NOT** push or twist the vehicle/load whilst it is supported on stands.
- ✗ **DO NOT** mix components between stands. Use only as supplied.
- ✗ **DO NOT** allow children or animals in the vicinity of a vehicle supported on axle stands.
- ✗ **DO NOT** leave a vehicle on axle stands in an area that could be considered a hazard to others or property.
- ✓ **Follow steps 1, 2 and 3 to correctly place vehicle/load onto axle stands.**

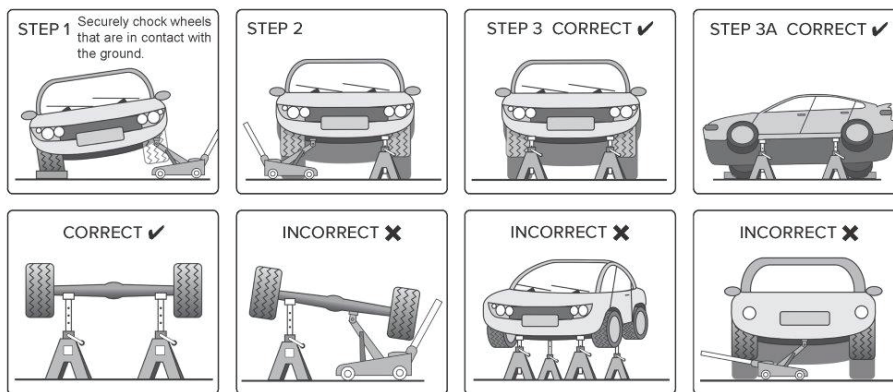
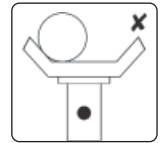
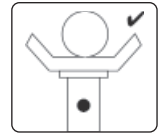

2. INTRODUCTION

Single-piece hydraulic unit with heavy chassis design. Integral American cog-type release mechanism and long 2-piece handle. Heavy-duty castors and large saddle design ease positioning under vehicle. Fitted with safety overload valve and pump-through valve to prevent handle locking at maximum ram extension. Supplied with a pair of pin type axle stands, 3tonne (3000kg) capacity per stand, 6tonne (6000kg) per pair. Ideal for loaded vans up to 3.5tonne GVW.

3. SPECIFICATION

Model No:	3010CX.V3
Jack Specification:	
Capacity:	3tonne
Consumable Parts:	JP17 - Rubber Jack Pad
Minimum Saddle Height:	130mm
Maximum Saddle Height:	520mm
Maximum Chassis Height:	172mm
Length:	659mm
Axle Stand Specification:	
Capacity Each:	3tonne
Capacity Pair:	6tonne
Minimum Working Height:	290mm
Maximum Working Height:	435mm

4. OPERATION - JACK

4.1. BEFORE FIRST USE

- 4.1.1. Assemble handle by sliding the two parts together and rotating until the locking pin clicks into position. Partially unscrew socket locking screw (fig 1 - 1) until handle slides fully into socket (fig 1 - 2). Tighten the socket locking screw to lock handle in place.
- 4.1.2. Before using jack for the first time, purge the hydraulic unit in order to eliminate any air in the system. Turn handle anti clockwise to open release valve.
- 4.1.3. Pump for 30 to 40 seconds. When complete, close the release valve by turning the handle clockwise.
- 4.1.4. Place a few drops of hydraulic jack oil on pump piston and pump handle several times to distribute oil. Thoroughly lubricate moving parts.

4.2. GENERAL JACKING

- ☐ **WARNING!** Before lifting ensure Safety instructions are read and understood.
- 4.2.1. Position the jack saddle under the vehicle manufacturer's recommended lifting point.

4.3. JACKING THE VEHICLE

4.3.1. Rotate handle clockwise to close the release valve.

4.3.2. Commence pumping handle up and down using maximum strokes until the jack saddle reaches the vehicle manufacturer's jacking point. Check the jacking point is centrally located on the saddle and raise the vehicle.

4.3.3. Should the jack become overloaded, a safety excess pressure valve will open, and stop the vehicle from lifting.

- ❑ **WARNING!** The jack is a lifting device only and must not be used to support the load. Use correctly rated axle stands to support the load.

4.4. LOWERING THE VEHICLE

4.4.1. If using axle stands, raise the jack high enough for the stands to be easily removed. Then turn handle anticlockwise very slowly to open the valve.

4.4.2. The lowering speed is controlled by the amount you turn the handle. Lower carefully, avoid any sudden changes in descent rate which would shock load the hydraulic system.

- ❑ **WARNING!** Ensure there are no persons or obstacles beneath the vehicle, or in the path of its descent.

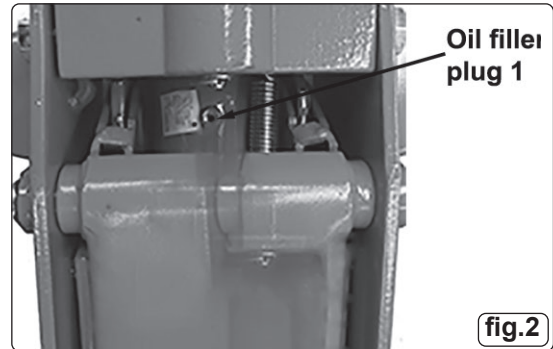
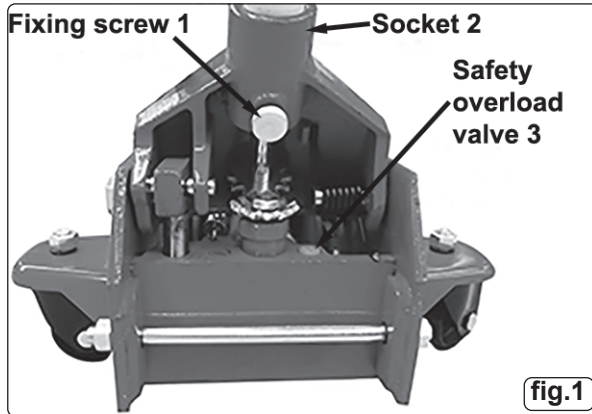

5. ASSEMBLY - AXLE STANDS

5.1. Insert the centre column (fig 3 - 1) into the centre tube (fig 3 - 2) of base frame (fig 3 - 4).

5.2. Adjust to the required height and insert the locking pin (fig 3 - 4).

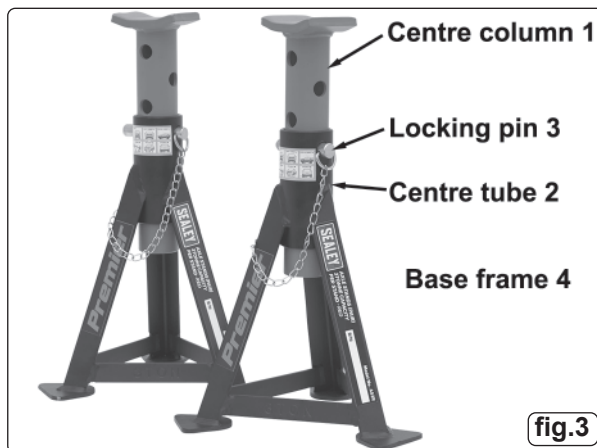

6. OPERATION - AXLE STANDS

6.1. Familiarise yourself with the product. Check that the stands are in good condition and that no damage has been sustained during transit.

6.2. Ensure the maximum load does not exceed 6 tonnes per pair of axle stands, (3 tonnes for each stand).

6.3. Refer to vehicle manufacturer's instructions for recommended support points. Check that the points are in good condition.

6.4. Ensure the vehicle has been placed in gear and that the handbrake has been applied. (For automatics select the 'Park' mode).

6.5. Adjust height of stand to correspond with the raised vehicle.

6.6. Check that the locking pin is correctly pushed all the way through the centre column and out of the other side, then position stands under vehicle at points recommended by vehicle manufacturer.

6.7. Carefully and slowly lower the load onto stands. Ensure the load bearing points sit in the center of the stand saddle and check that the stands are stable and not leaning. Also ensure that there are no objects or persons that could impede the safe lowering of the vehicle onto the stands.

6.8. To remove stands jack vehicle slightly so that stand can be removed.

6.9. After use, hold the centre column (fig 1 - 1) firmly when removing the locking pin (fig 1 - 3). Failure to do so will allow the center column to fall freely through the main center tube with the risk of personal injury.

- ❑ **WARNING!** Ensure you follow all instructions carefully. Failure to note these warnings may cause damage, serious injury or loss of life.

7. MAINTENANCE - JACK

7.1. When the jack is not in use, the ram and the handle socket should be in their lowest positions to minimise corrosion.

When the jack is not in use, the ram should be in its lowest position to minimise corrosion. Remove the handle to inactivate jack.

7.2. Keep the jack clean and lubricate all moving parts with oil on a regular basis.

- 7.3. Before each use check for broken, cracked, bent, or loose parts, or any visible damage to ram, pump, saddle, lifting arm, frame and all parts including nuts, bolts, pins and other fasteners. If any suspect item is found remove jack from service and take necessary action to remedy the problem.
- × **DO NOT** use the jack if believed to have been subjected to abnormal load or shock load.
- 7.4. Periodically check the pump piston and the ram for signs of corrosion. Clean exposed areas with a clean oiled cloth.
- 7.5. After one year the oil should be replaced in order to extend the life of the jack. Use hydraulic jack oil only.
- **WARNING!** Maintenance and repair must only be carried out by a qualified person. Contact your Sealey stockist for details.
- 7.6. **TO CHECK THE OIL LEVEL**
- 7.6.1. Fully lower the jack and remove filler plug (fig 2 - 1) The correct level is the bottom of the screw hole. If oil level is low, fill as required. Pump jack 5 or 6 times to expel air. Pump jack up to full height and pour off excess oil before refitting plug.
- × **DO NOT** touch the safety overload valve (fig 1 - 3).
- NOTE:** Use a good quality jack oil, such as SEALEY HYDRAULIC JACK OIL.
- **WARNING: DO NOT** use brake fluid, or any fluid other than hydraulic jack oil as this may cause serious damage to the jack and will invalidate the warranty.
- 7.7. To drain the oil, remove the filler plug and raise front of jack. Make sure that no dirt is allowed to enter the hydraulic system.

IMPORTANT: NO RESPONSIBILITY IS ACCEPTED FOR INCORRECT USE OF THIS PRODUCT.

Hydraulic products are only repaired by local service agents. We have service/repair agents in all parts of the UK.

DO NOT RETURN PRODUCT TO US. Please telephone us on 01284 757500 to obtain the address and phone number of your local agent.

If the jack is under guarantee please contact your stockist.

De-commissioning Product

Should the jack become completely unserviceable and require disposal, draw off the oil into an approved container and dispose of the jack and the oil according to local regulations.

8. MAINTENANCE - AXLE STANDS

- 8.1. Before each use check to ensure stands and stand welds are not cracked, and that there are no missing and/or damaged parts.
- **WARNING!** Any stand that appears to be damaged in any way must be removed from service immediately.
- 8.1.1. Ensure the locking pins are in good order and condition.
- 8.1.2. Due to the potential hazards associated with these stands, do not misuse, or make any modification to the stands or components.
- 8.1.3. It is the responsibility of the stands owner to ensure the operator has read these instructions, and that the operator is familiar with the stands use and limitations.

9. TROUBLESHOOTING - JACK

PROBLEM	POSSIBLE CAUSE	REMEDY
Jack will not lift the load	1) Overloaded 2) Oil level low 3) Release valve not correctly closed 4) Air in system 5) Piston rod not functioning 6) Packing worn or defective	1) Be sure to use jack with adequate capacity 2) Top up oil level 3) Check and close release valve 4) Open release valve and pump the handle a few times. Close valve and re-try 5) Clean and replace oil 6) Replace packing
Jack does not lift high enough Or feels "spongy"	1) Oil level too high or too low 2) Worn seals 3) Air in system 4) Release valve not closed	1) Fill or remove excess oil 2) Return jack to local service agent 3) Open release valve and pump the handle a few times. Close valve and re-try 4) Check and close release valve
Jack lifts poorly	1) Pump packing or valves malfunctioning 2) Oil is dirty 3) Air in the system	1) Replace packing and/or clean valves 2) Replace oil 3) Open release valve and pump the handle a few times. Close valve and re-try
Jack lifts but will not hold load	1) Release valve partially open 2) Dirt on valve seats 3) Air in system 4) Faulty seals 5) Packing worn or defective	1) Check and close release valve 2) Lower jack, close release valve. Place foot on front wheel and pull up lifting arm to it's full height by hand. Open the release valve to lower arm 3) Open release valve and pump the handle a few times. Close valve and re-try 4) Replace packing or contact local service agent 5) Replace packing
Jack will not lower completely	1) Unit requires lubrication 2) Piston rod bent or damaged 3) Jack frame/link system distorted due to overloading/ poor positioning 4) Air in system 5) Release valve partially closed 6) Jack spring damaged or unhooked.	1) Oil all external moving parts 2) Replace rod or contact local service agent 3) Replace damaged parts or contact local service agent 4) Open release valve and pump the handle a few times. Close valve and re-try 5) Check and fully open release valve 6) Replace spring or contact local service agent
Jack does not lower at all	1) Release valve closed	1) Check and fully open release valve



ENVIRONMENT PROTECTION

Recycle unwanted materials instead of disposing of them as waste. All tools, accessories and packaging should be sorted, taken to a recycling centre and disposed of in a manner which is compatible with the environment. When the product becomes completely unserviceable and requires disposal, drain any fluids (if applicable) into approved containers and dispose of the product and fluids according to local regulations.

Note: It is our policy to continually improve products and as such we reserve the right to alter data, specifications and component parts without prior notice. Please note that other versions of this product are available. If you require documentation for alternative versions, please email or call our technical team on technical@sealey.co.uk or 01284 757505.

Important: No Liability is accepted for incorrect use of this product.

Warranty: Guarantee is 12 months from purchase date, proof of which is required for any claim.

Sealey Group, Kempson Way, Suffolk Business Park, Bury St Edmunds, Suffolk. IP32 7AR



01284 757500



01284 703534



sales@sealey.co.uk



www.sealey.co.uk