

All drawings are actual size
Profile drawing shows back of knife

Tool Steel Multi Profile Cutters - 40x4mm

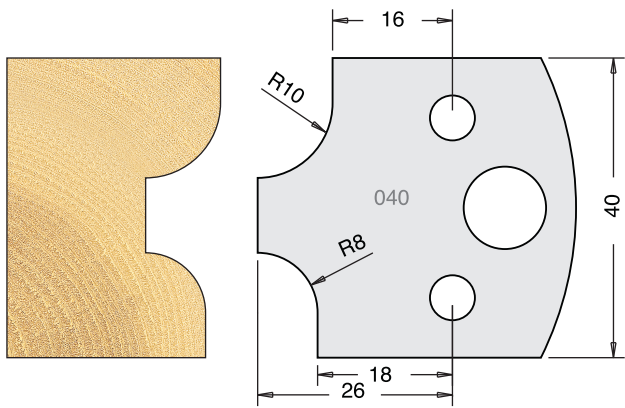

Knives	IT/33 040 40	£9.00
Limitors	IT/34 040 40	£8.50

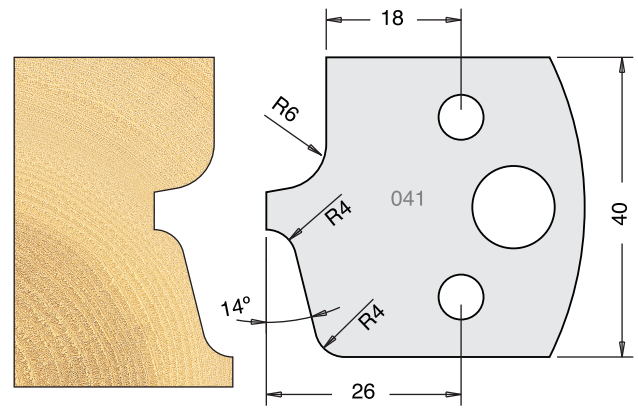

Knives	IT/33 041 40	£9.00
Limitors	IT/34 041 40	£8.50

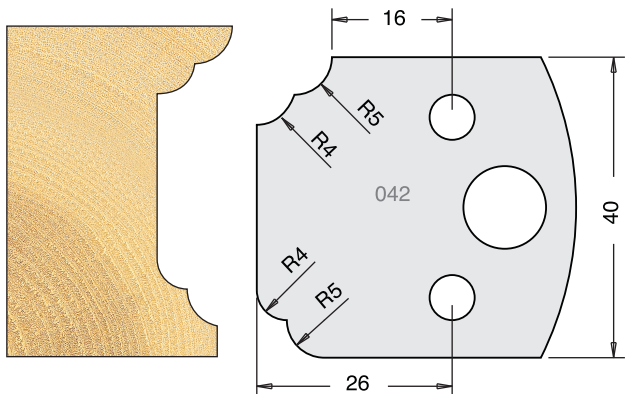

Knives	IT/33 042 40	£9.00
Limitors	IT/34 042 40	£8.50

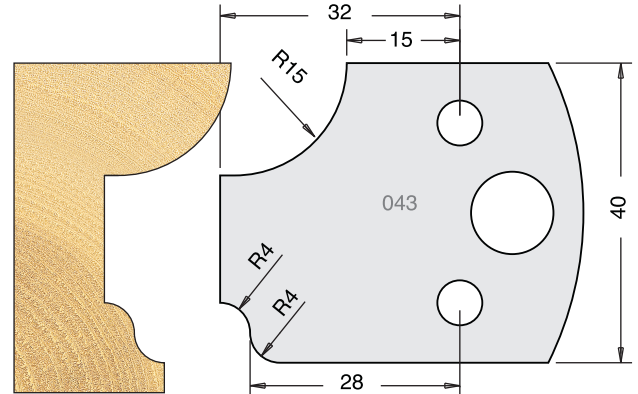

Knives	IT/33 043 40	£9.00
Limitors	IT/34 043 40	£8.50

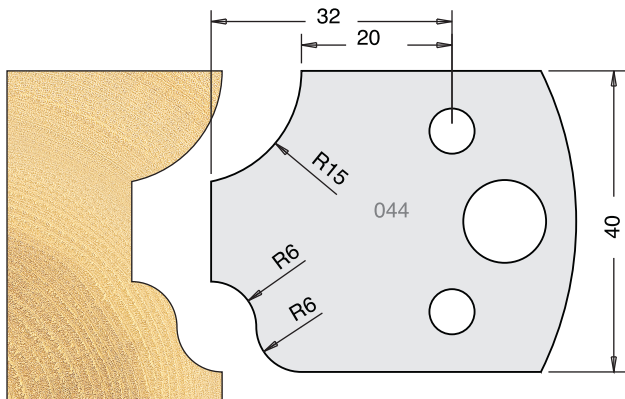

Knives	IT/33 044 40	£9.00
Limitors	IT/34 044 40	£8.50

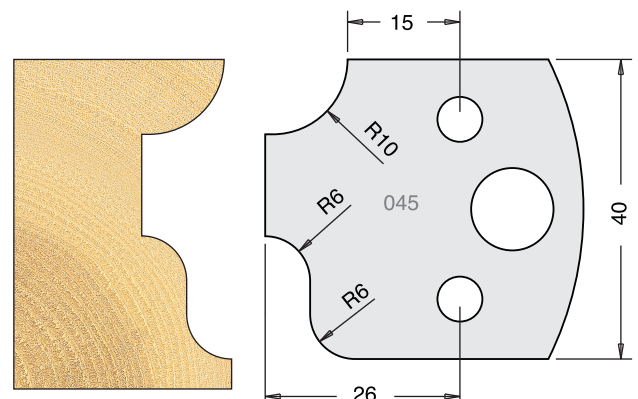

Knives	IT/33 045 40	£9.00
Limitors	IT/34 045 40	£8.50

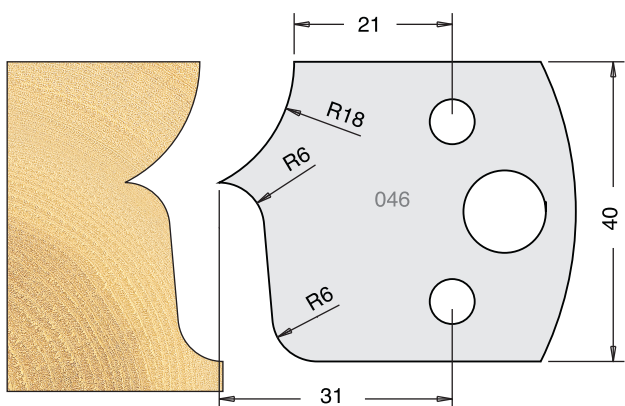

Knives	IT/33 046 40	£9.00
Limitors	IT/34 046 40	£8.50

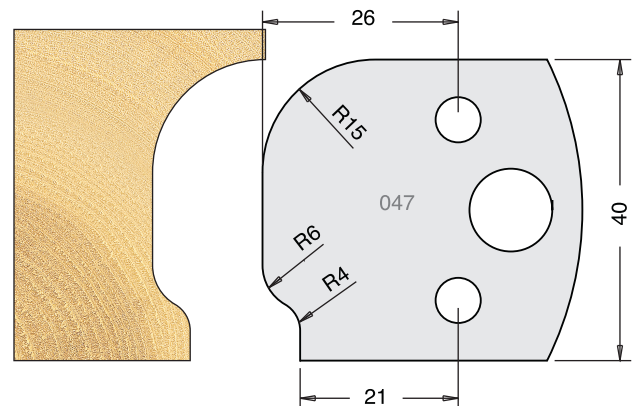

Knives	IT/33 047 40	£9.00
Limitors	IT/34 047 40	£8.50

All blades sold as a pair
All prices are exclusive of VAT

