

All drawings are actual size
Profile drawing shows back of knife

Tool Steel Multi Profile Cutters - 40x4mm

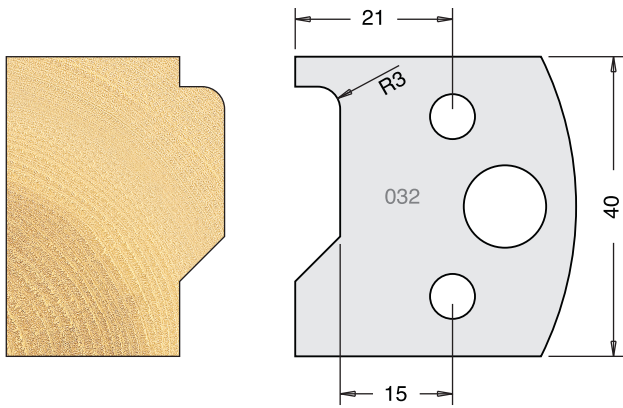

Knives	IT/33 032 40	£9.00
Limitors	IT/34 032 40	£8.50

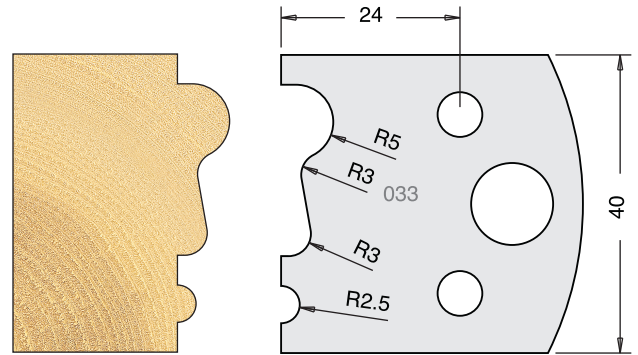

Knives	IT/33 033 40	£9.00
Limitors	IT/34 033 40	£8.50

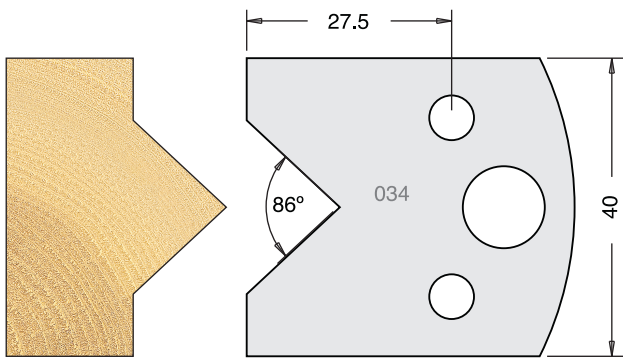

Knives	IT/33 034 40	£9.00
Limitors	IT/34 034 40	£8.50

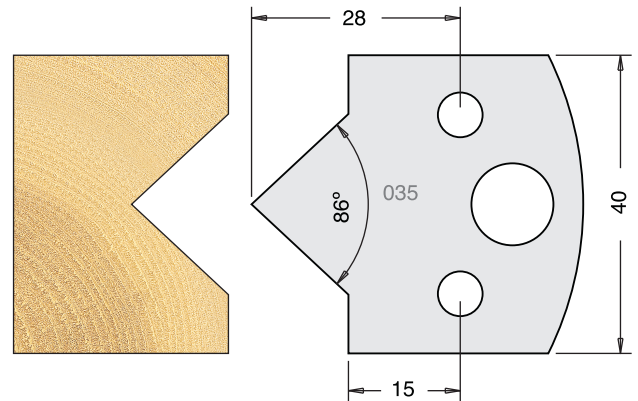

Knives	IT/33 035 40	£9.00
Limitors	IT/34 035 40	£8.50

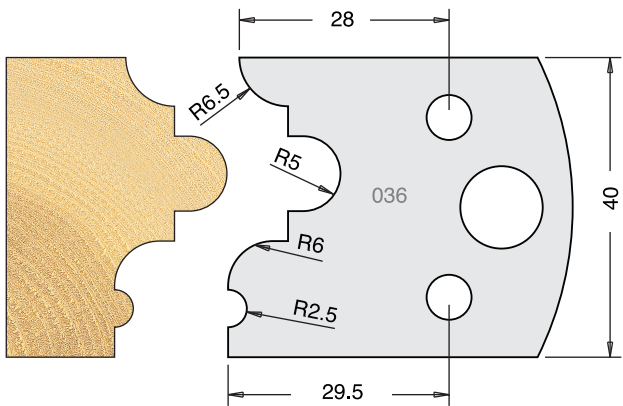

Knives	IT/33 036 40	£9.00
Limitors	IT/34 036 40	£8.50

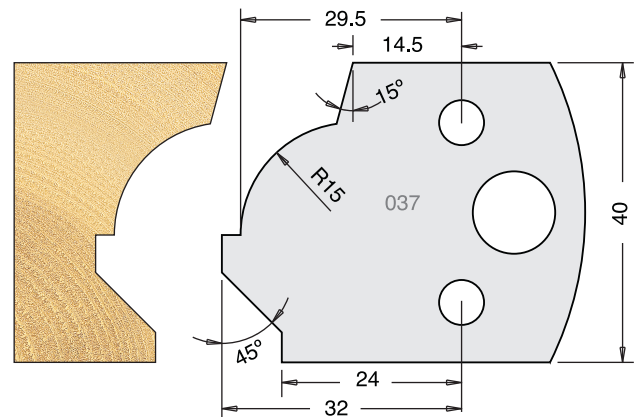

Knives	IT/33 037 40	£9.00
Limitors	IT/34 037 40	£8.50

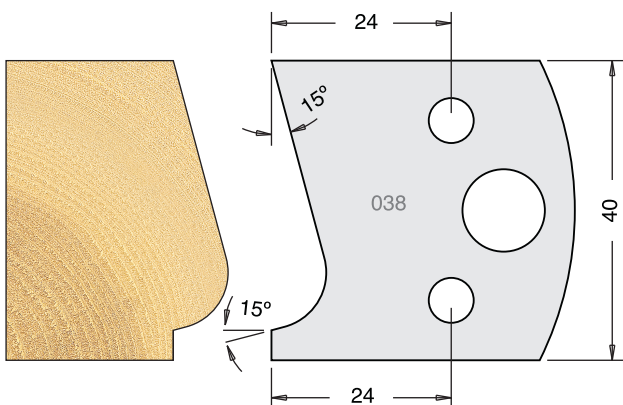

Knives	IT/33 038 40	£9.00
Limitors	IT/34 038 40	£8.50

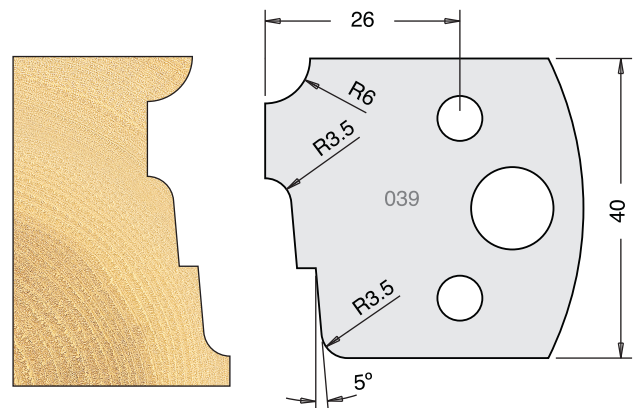

Knives	IT/33 039 40	£9.00
Limitors	IT/34 039 40	£8.50

All blades sold as a pair
All prices are exclusive of VAT