

All drawings are actual size
Profile drawing shows back of knife

Tool Steel Multi Profile Cutters - 40x4mm

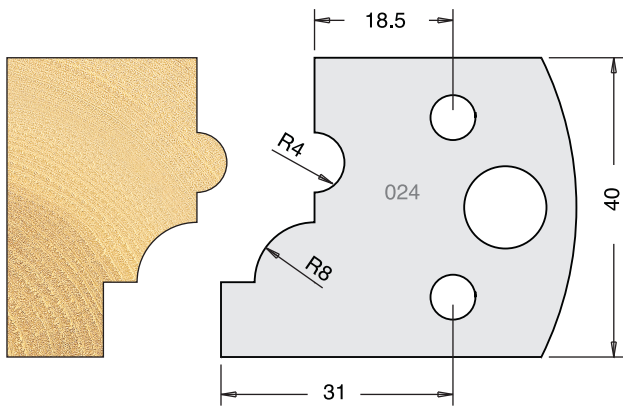

Knives	IT/33 024 40	£9.00
Limitors	IT/34 024 40	£8.50

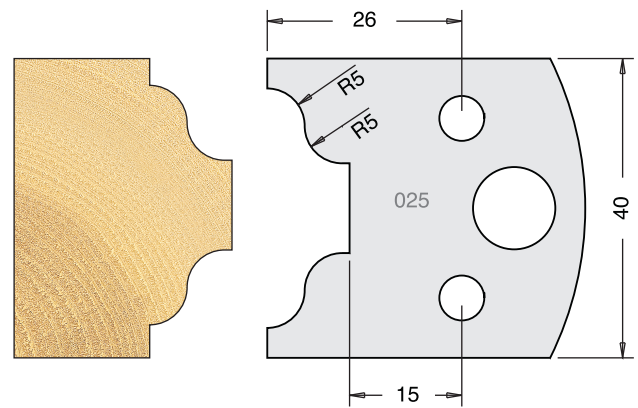

Knives	IT/33 025 40	£9.00
Limitors	IT/34 025 40	£8.50

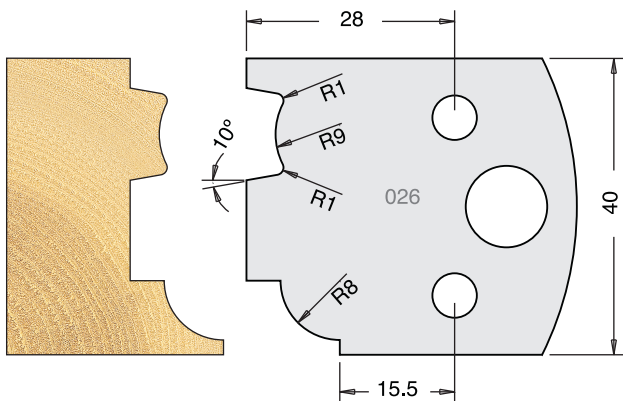

Knives	IT/33 026 40	£9.00
Limitors	IT/34 026 40	£8.50

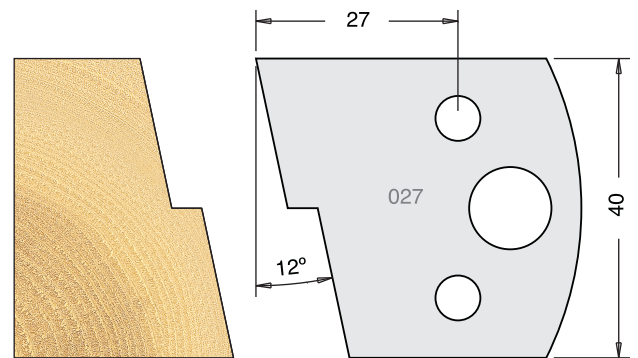

Knives	IT/33 027 40	£9.00
Limitors	IT/34 027 40	£8.50

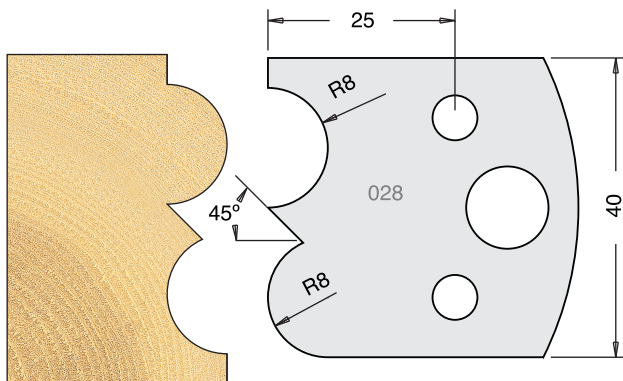

Knives	IT/33 028 40	£9.00
Limitors	IT/34 028 40	£8.50

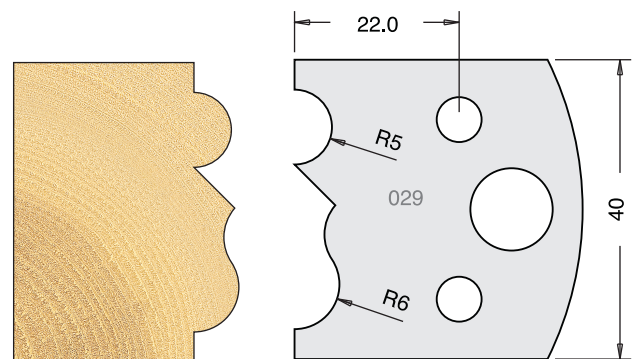

Knives	IT/33 029 40	£9.00
Limitors	IT/34 029 40	£8.50

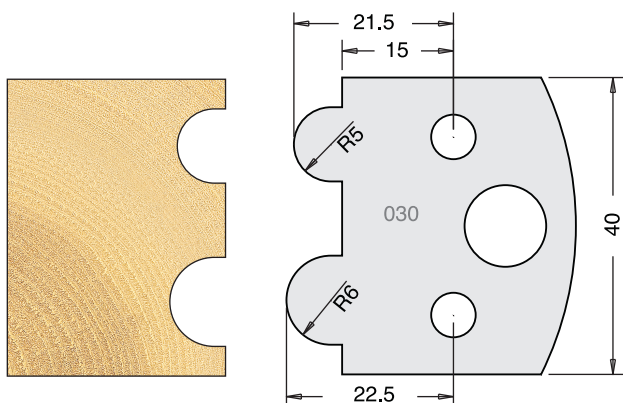

Knives	IT/33 030 40	£9.00
Limitors	IT/34 030 40	£8.50

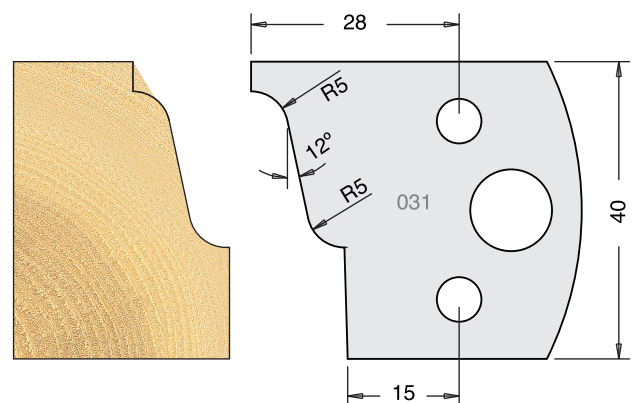

Knives	IT/33 031 40	£9.00
Limitors	IT/34 031 40	£8.50

All blades sold as a pair
All prices are exclusive of VAT

