

All drawings are actual size
Profile drawing shows back of knife

Tool Steel Multi Profile Cutters - 40x4mm

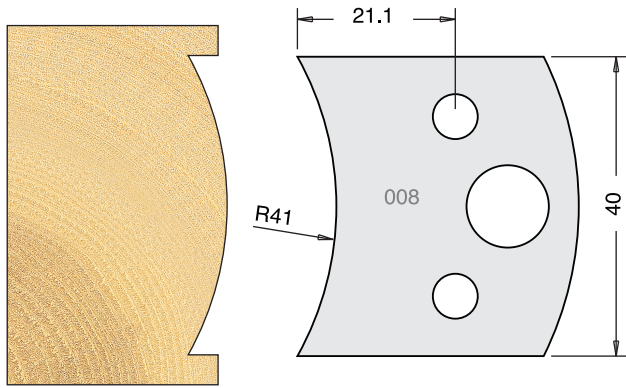

Knives	IT/33 008 40	£9.00
Limitors	IT/34 008 40	£8.50

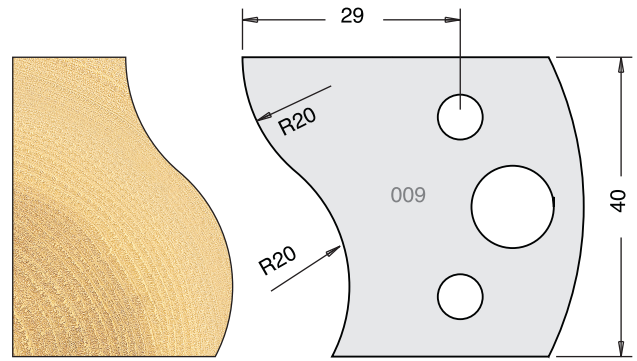

Knives	IT/33 009 40	£9.00
Limitors	IT/34 009 40	£8.50

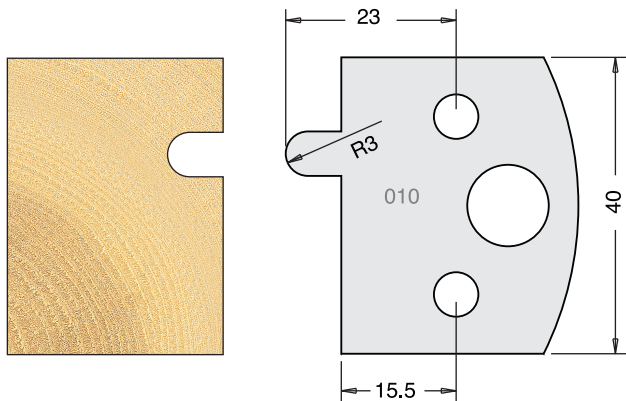

Knives	IT/33 010 40	£9.00
Limitors	IT/34 010 40	£8.50

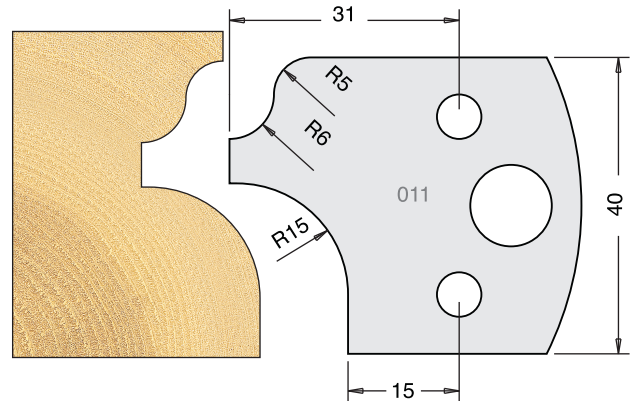

Knives	IT/33 011 40	£9.00
Limitors	IT/34 011 40	£8.50

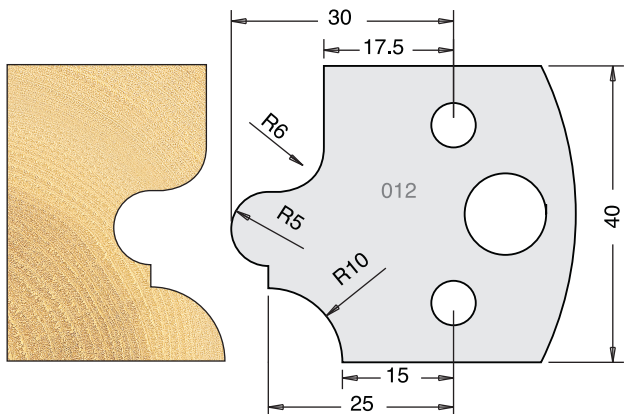

Knives	IT/33 012 40	£9.00
Limitors	IT/34 012 40	£8.50

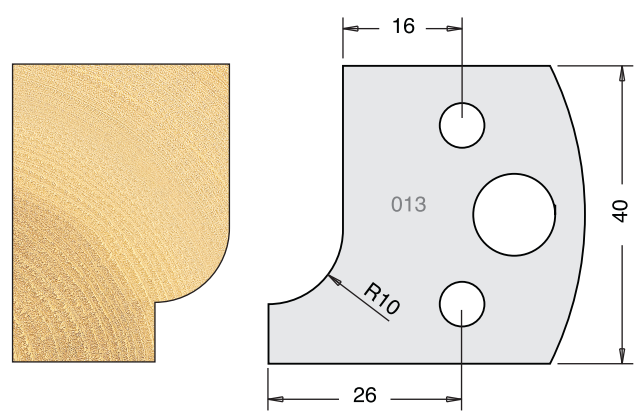

Knives	IT/33 013 40	£9.00
Limitors	IT/34 013 40	£8.50

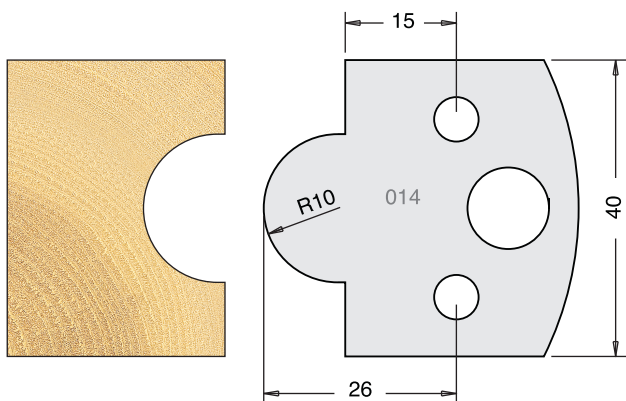

Knives	IT/33 014 40	£9.00
Limitors	IT/34 014 40	£8.50

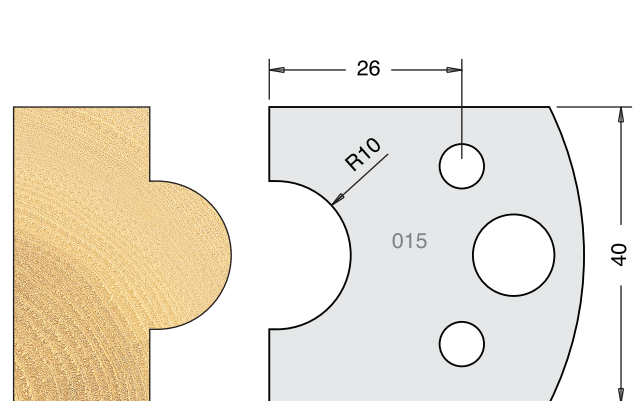

Knives	IT/33 015 40	£9.00
Limitors	IT/34 015 40	£8.50

All blades sold as a pair
All prices are exclusive of VAT

