

SPINDLE TOOLING

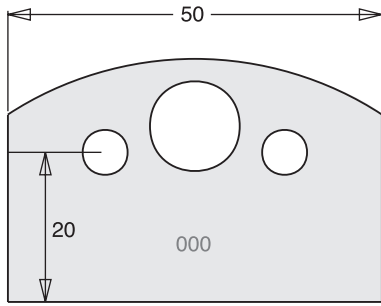

All Blades Sold as a Pair

Tool Steel Multi Profile Cutters - 50x4mm



Kn IT/33 000 50
Li IT/34 000 50

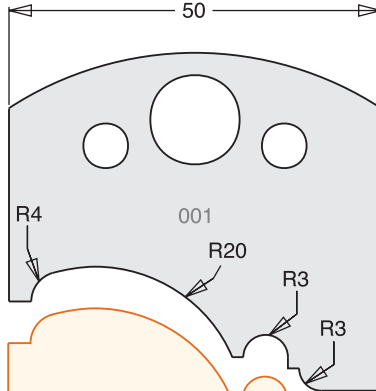

Kn IT/33 001 50
Li IT/34 001 50

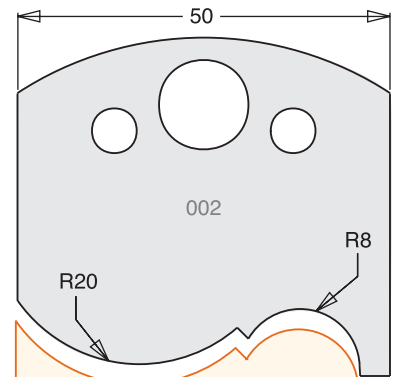

Kn IT/33 002 50
Li IT/34 002 50

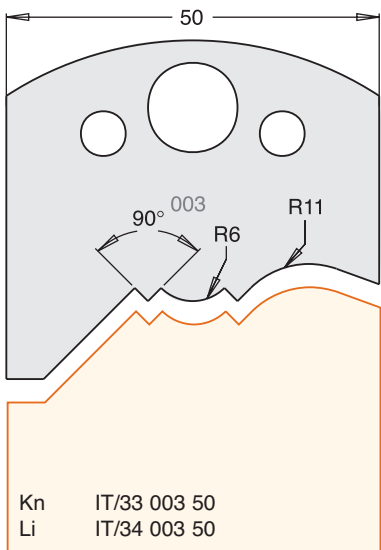
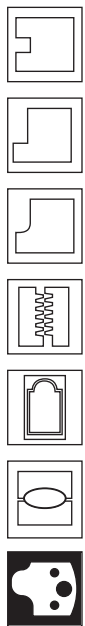

Kn IT/33 003 50
Li IT/34 003 50

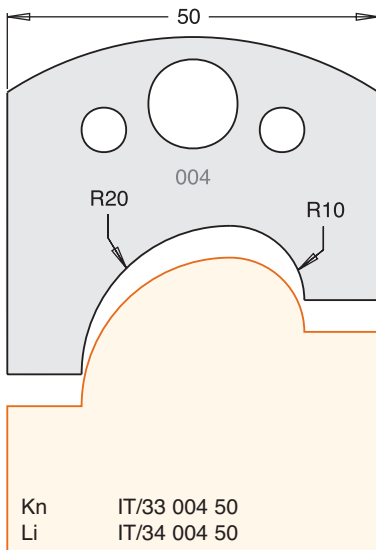

Kn IT/33 004 50
Li IT/34 004 50

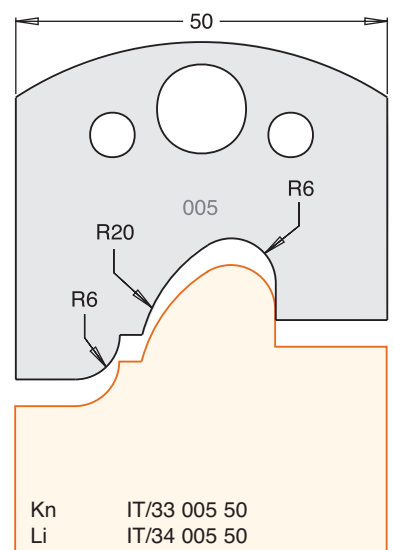

Kn IT/33 005 50
Li IT/34 005 50

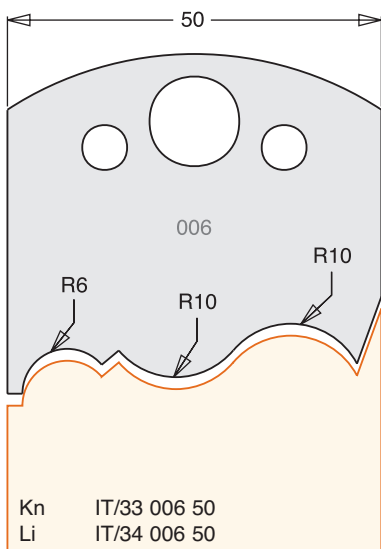

Kn IT/33 006 50
Li IT/34 006 50

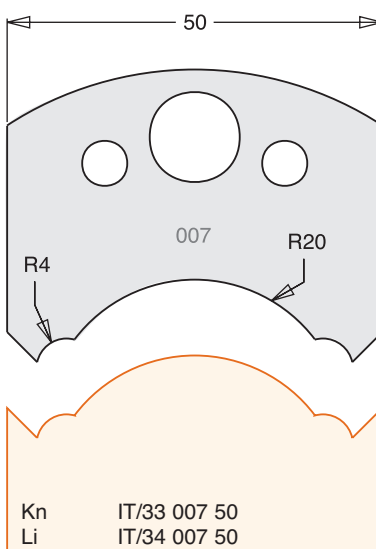

Kn IT/33 007 50
Li IT/34 007 50

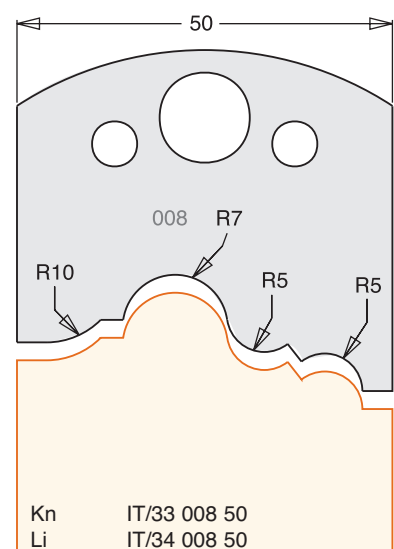

Kn IT/33 008 50
Li IT/34 008 50

All images are actual size.

