

CNC TOOL HOLDERS & ARBORS

Complete range of high precision CNC chucks and arbors suitable for all popular makes of machine and every production environment. Chucks and arbors are supplied complete with clamping nuts. Pull studs, collets and spanners are sold separately.

SK30 TOOL HOLDERS WITH PULL STUD

- SK30 high precision CNC chuck complete with pull studs for various makes of CNC machines.
- Complete with ball bearing clamping nut.
- Supplied without collets, for ER32 & ER40 collets see page 140.

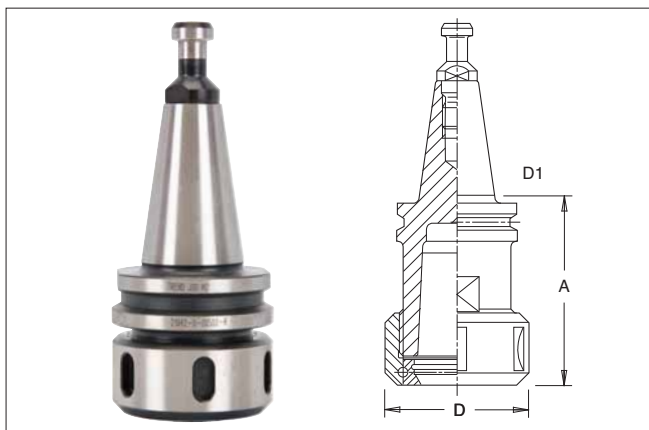

Adapter Standard	øD	A	Collet Standard	Product Ref.	Stock	Price
------------------	----	---	-----------------	--------------	-------	-------

For IMA, MAKA, Reinchenbacher, Weeke, Busellato

SK 30	50	68	ER32	IT/TH/001	N	£100.43
SK 30	63	68	ER40	IT/TH/002	N	£100.43

For Biesse (from 09/92), Masterwood (HSD motor)

SK 30	50	50	ER32	IT/TH/003	N	£100.43
SK 30	63	60	ER40	IT/TH/004	N	£100.43

For Alberti, Masterwood (Colombo motor)

SK 30	50	68	ER32	IT/TH/005	N	£100.43
SK 30	63	68	ER40	IT/TH/006	N	£100.43

HSK63-F TOOL HOLDERS

- HSK-63F high precision CNC chuck for various makes of CNC machines.
- Complete with ball bearing clamping nut.
- Supplied without collets, for ER32 & ER40 collets see pages 139.



Adapter Standard	øD	A	A1	Collet Standard	Product Ref.	Stock	Price
------------------	----	---	----	-----------------	--------------	-------	-------

HSK63-F	50	76	18	ER32	IT/641 031	Y	£89.00
HSK63-F	63	78	18	ER40	IT/641 030	Y	£99.00

SPARE PARTS

Description	Product Ref.	Stock	Price
Ball bearing clamping nut to suit ER32 chucks (M40x1.5)	IT/TH/CNM40	N	£61.65
Ball bearing clamping nut to suit ER40 chucks	IT/TH/CNM48	N	£65.00
C-Spanner to suit M40 clamping nut	IT/TH/CSM40	N	£16.68
C-Spanner to suit M48 clamping nut	IT/TH/CSM48	N	£15.42
Engineers' wrench SW46	IT/TH/EW46	N	£23.70

PULL STUDS FOR TOOL HOLDERS

- Range of pull-studs to suit SK30 tool holders shown on page 140.

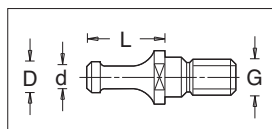

For Machines
Morbidelli, SCM

Adapter	øD	ød	L	G	Product Ref.	Stock	Price
---------	----	----	---	---	--------------	-------	-------

ISO 30	8.5	6.5	22	M10	IT/650 010	Y	£21.31
--------	-----	-----	----	-----	------------	---	--------

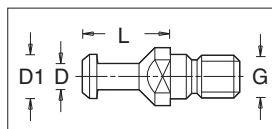

For Machines

Busellato, Weeke, Bulleri, Maka, IMA
Cosmec, Reinchenbacher

Adapter	øD	ød	L	G	Product Ref.	Stock	Price
---------	----	----	---	---	--------------	-------	-------

ISO 30	13	9	24	M12	IT/650 011	Y	£24.79
ISO 40	19	14	26	M16	IT/650 020	Y	£27.36

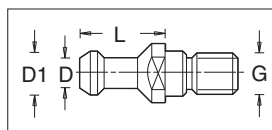

For Machines

Alberti, Vitap, Masterwood

Adapter	øD	ød	L	G	Product Ref.	Stock	Price
---------	----	----	---	---	--------------	-------	-------

ISO 30	13	9	24	M12	IT/650 013	Y	£25.62
--------	----	---	----	-----	------------	---	--------

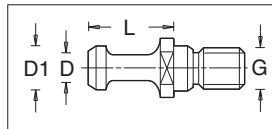

For Machine

Esseteam

Adapter	øD	ød	L	G	Product Ref.	Stock	Price
---------	----	----	---	---	--------------	-------	-------

ISO 30	12	8	24	M12	IT/650 014	Y	£25.62
--------	----	---	----	-----	------------	---	--------

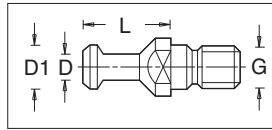

For Machine

CMS

Adapter	øD	ød	L	G	Product Ref.	Stock	Price
---------	----	----	---	---	--------------	-------	-------

ISO 30	12.8	9	24	M12	IT/650 015	Y	£25.62
--------	------	---	----	-----	------------	---	--------

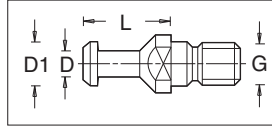

For Machine

Biesse (Before 09/92)

Adapter	øD	ød	L	G	Product Ref.	Stock	Price
---------	----	----	---	---	--------------	-------	-------

ISO 30	12	8	24	M12	IT/650 017	Y	£22.56
--------	----	---	----	-----	------------	---	--------

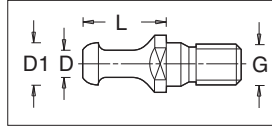

For Machines

Biesse (After 09/92), Masterwood

Adapter	øD	ød	L	G	Product Ref.	Stock	Price
---------	----	----	---	---	--------------	-------	-------

ISO 30	12	8	24	M12	IT/650 018	Y	£23.47
--------	----	---	----	-----	------------	---	--------

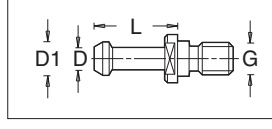

For Machines

Shoda, Heian

Adapter	øD	ød	L	G	Product Ref.	Stock	Price
---------	----	----	---	---	--------------	-------	-------

BT 30	11	7	23	M12	IT/650 031	Y	£25.62
BT 35	13	8.5	28	M12	IT/650 040	Y	£26.53