

IT/105 356 8 (a = 70°)

Ref.	IT/310 523 0	IT/193 354 8
Size	27x9x1.5	M3.5x4.8
Price	£18.30	£1.62

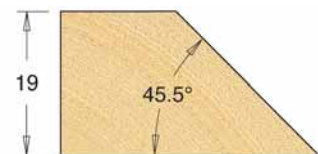

IT/105 360 8 (a = 91°)

Ref.	IT/310 500 3	IT/193 354 8
Size	28x12x1.5	M3.5x4.8
Price	£13.44	£1.62

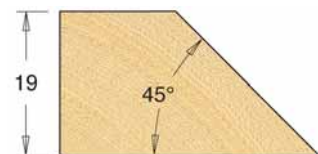

IT/105 361 8 (a = 90°)

Ref.	IT/310 500 3	IT/193 354 8
Size	28x12x1.5	M3.5x4.8
Price	£13.44	£1.62

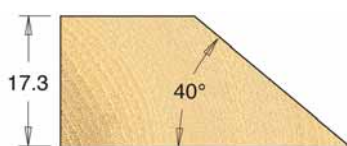

IT/105 362 8 (a = 100°)

Ref.	IT/310 500 3	IT/193 354 8
Size	28x12x1.5	M3.5x4.8
Price	£13.44	£1.62

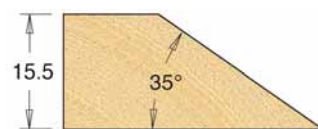

IT/105 364 8 (a = 110°)

Ref.	IT/310 500 3	IT/193 354 8
Size	28x12x1.5	M3.5x4.8
Price	£13.44	£1.62

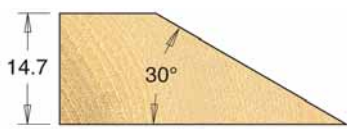

IT/105 400 8 (a = 120°)

Ref.	IT/310 500 6	IT/193 148 1
Size	29.8x12x1.5	M4x5.6
Price	£13.44	£1.61

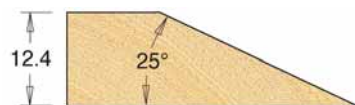

IT/105 366 8 (a = 130°)

Ref.	IT/310 500 6	IT/193 148 1
Size	29.8x12x1.5	M4x5.6
Price	£13.44	£1.61

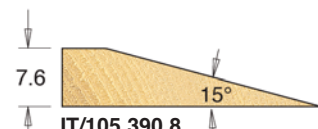

IT/105 390 8 (a = 150°)

Ref.	IT/310 500 6	IT/193 148 2
Size	29.8x12x1.5	M4x5.6
Price	£13.44	£1.16



IT/105 368 8 (a = 160°)

Ref.	IT/310 500 5	IT/193 148 2
Size	29.8x12x1.5	M4x5.6
Price	£13.44	£1.16

Desc.	Torx® Key
Ref.	IT/194 101 5
Size	T-15
Price	£3.14

DISPOSABLE INSERT BALL GROOVER ROUTER CUTTERS - 12.7MM SHANK

- Complete with two cutting flutes.
- Suitable for 3D carving and routing of ball grooves in softwood, hardwood and man-made board.
- A groove at the D1 width should be run with a straight router cutter before running the ball groove.
- Replaceable inserts ensure a constant cutting diameter and finish quality.
- For use on routers and light machining centres with CNC control.
- Recommended RPM (n): 18,000.

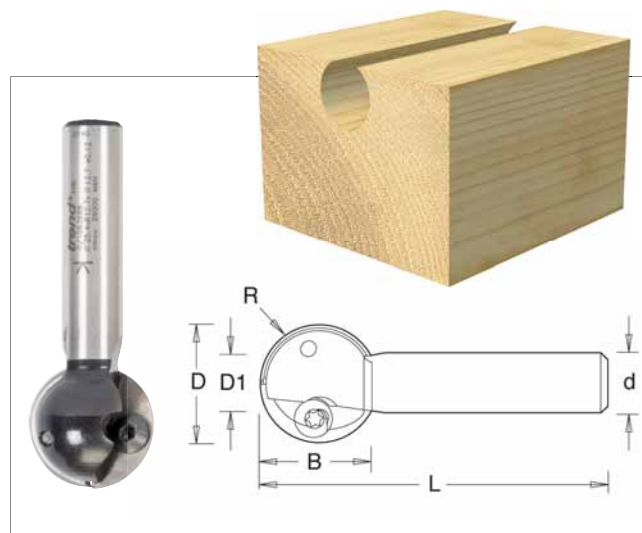

Ød = 12.7mm

øD	D1	R	B	L	Product Ref	Stock	Price
12.7	10.3	6.35	10.3	66.7	IT/106 362 8	Y	£42.47
16.0	13.3	8.0	14.0	70.0	IT/106 364 8	Y	£46.24
19.0	15.0	9.5	17.0	66.7	IT/106 366 8	Y	£54.53
25.4	17.0	12.7	23.8	73.0	IT/106 368 8	Y	£57.88

SPARE PARTS

Desc.	T.C. Blade	Torx® Screw	Torx® Key
Ref.	IT/310 650 1	IT/193 400 0	IT/194 111 0
Size	6.35x10.3	M3x4	T-9
Price	£17.04	£1.67	£9.39

IT/106 362 8

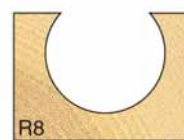

IT/310 650 2	IT/193 400 0	IT/194 111 0
8x14	M3x4	T-9
£18.30	£1.67	£9.39

IT/106 364 8

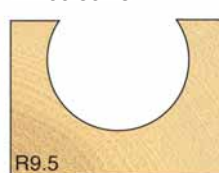

IT/310 650 3	IT/193 400 0	IT/194 111 0
9.5x17	M3x4	T-9
£18.30	£1.67	£9.39

IT/106 366 8

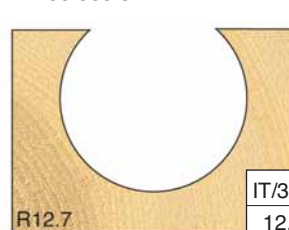

IT/310 650 4	IT/193 148 2	IT/194 101 5
12.7x23.8	M4x5.6	T15
£20.75	£1.16	£3.14

IT/106 368 8