

DISPOSABLE INSERT ROUTER CUTTERS - ONE FLUTE

- Unique tool body engineered to quickly interchange inserts while mounted on the machine to eliminate down time.
- Tool bodies are expertly balanced for virtually vibration free cuts and minimal stress on the tool and spindle.
- For use on routers and machining centres with CNC control.

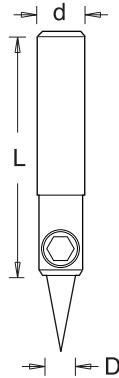

BODY ONLY KNIFE NOT INCLUDED

øD	L	ød	Product Ref.	Stock	Price
12	65	6.35	IT/G185 3X0 4	Y	£30.41
12	65	8	IT/G185 3X0 5	Y	£30.41
12	65	12	IT/G185 3X0 9	Y	£30.41
12	65	12.7	IT/G185 3X0 8	Y	£30.41

FOR CUTTING, PLUNGING & CHAMFERING PLASTIC

- Suitable for cutting and chamfering in a variety of plastic sheet products. 13 different inserts are available for various sheet thicknesses.
- Time saving system cuts and chamfers both sides of the sheet in one pass without melting the edges.
- Tool designed for use with all forms of plastic sheet materials for sign making, lettering and producing display cases.
- Designed to only penetrate the spoil-board by 0.2mm.

ALL CUTTING, PLUNGING & CHAMFERING INSERT KNIVES SHARE THE SAME SPECIFICATIONS AS SHOWN BELOW

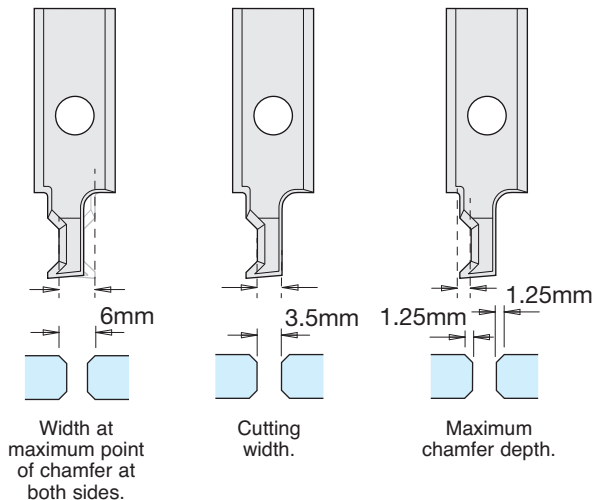

CUTS, PLUNGES & CHAMFERS THE TOP & BOTTOM OF BOTH SIDES OF PLASTIC

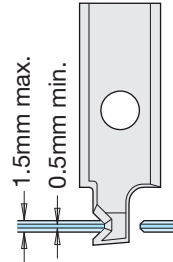

Product Ref.	Stock	Price
IT/318 504 0	Y	£20.63

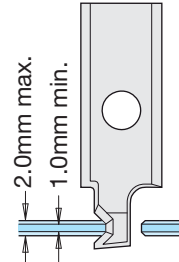

Product Ref.	Stock	Price
IT/318 503 6	Y	£20.63

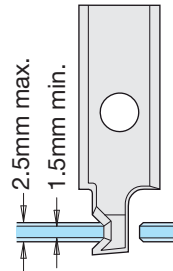

Product Ref.	Stock	Price
IT/318 500 2	Y	£20.63

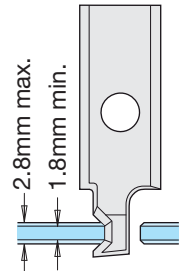

Product Ref.	Stock	Price
IT/318 503 7	Y	£20.63

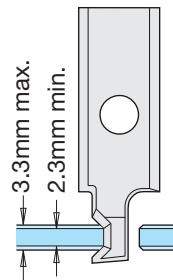

Product Ref.	Stock	Price
IT/318 504 1	Y	£20.63

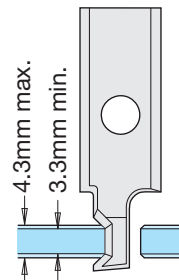

Product Ref.	Stock	Price
IT/318 504 2	Y	£20.63

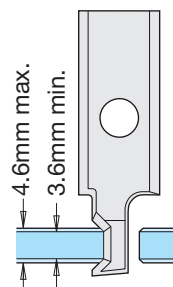

Product Ref.	Stock	Price
IT/318 501 2	Y	£20.63

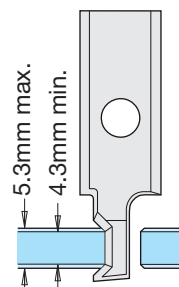

Product Ref.	Stock	Price
IT/318 504 3	Y	£20.63