

















DISPOSABLE INSERT PROFILE (CONTINUED)
SPARE PARTS

CUTTER 1				
Desc.	Wedge	Set Screw	Stopper Screw	Hex Key
Prod. Ref.	IT/199 032 6	IT/193 026 5	IT/193 148 2	IT/194 003 5
Size	L=14	M6x16	M4x5.6	S3
Price	£7.31	£1.05	£1.16	£4.16





CUTTER 2		
Desc.	T.C. Blade	T.C. Blade Nut
Prod. Ref.	IT/300 850 4/10	IT/300 850 2/10
Size	18x18x2.5	14x14x1.2
Price	£71.75	£28.17

	
Torx® Screw	Torx® Key
IT/193 030 0	IT/194 110 0
M4x4	T9
£2.09	£2.09

CUTTER 3				
Desc.	T.C. Blade	Wedge	Set Screw	Hex Key
Prod. Ref.	IT/311 451 2/10	IT/199 038 5	IT/193 026 5	IT/194 003 5
Size	14.3x12x1.5	L=13.5	M6x16	S3
Price	£49.02	£7.31	£1.05	£4.16

CUTTER 4				
Desc.	T.C. Blade	Wedge	Set Screw	Hex Key
Prod. Ref.	IT/300 052 7/10	IT/199 038 5	IT/193 026 5	IT/194 003 5
Size	15x12x1.5	L=13.5	M6x16	S3
Price	£28.17	£7.31	£1.05	£4.16

CUTTER 5				
Desc.	Wedge	Set Screw	Stopper Screw	Hex Key
Prod. Ref.	IT/199 032 6	IT/193 026 5	IT/193 148 2	IT/194 003 5
Size	L=14	M6x16	M4x5.6	S3
Price	£7.31	£1.05	£1.16	£4.16

CUTTER 6				
Desc.	T.C. Blade	Wedge	Set Screw	Hex Key
Prod. Ref.	IT/311 451 2/10	IT/199 038 5	IT/193 026 5	IT/194 003 5
Size	14.3x12x1.5	L=13.5	M6x16	S3
Price	£49.02	£7.31	£1.05	£4.16

T.C. Blades 				
	Profile 1	Profile 2	Profile 3	Profile 4
Size	15.7x30x1	15.7x30x1	15.7x30x1	15.7x30x1
CUTTER 1	IT/311 752 0	IT/311 752 1	IT/311 752 2	IT/311 752 3
	£26.48	£26.48	£26.48	£26.48
CUTTER 5	IT/311 752 0L	IT/311 752 1L	IT/311 752 2L	IT/311 752 3L
	£26.48	£26.48	£26.48	£26.48

KEY

Spare Knives & Scorers - Product Reference ending in /10 are sold in packs of ten.

Stock - Y means normally kept in stock for next day delivery.

N means not normally held in stock, delivery in a short time.

DISPOSABLE INSERT MULTI PROFILE
RAISED PANEL ROUTER CUTTERS
- TWO FLUTE

- Suitable for producing various raised panel profiles in softwoods, hardwoods and man-made boards.
- Cutter can also be supplied complete with a small trimmer, IT/807 301 5, for machining the edge of the panel.
- For use on routers and machining centres with CNC control.
- Recommended RPM (n): 12,000.

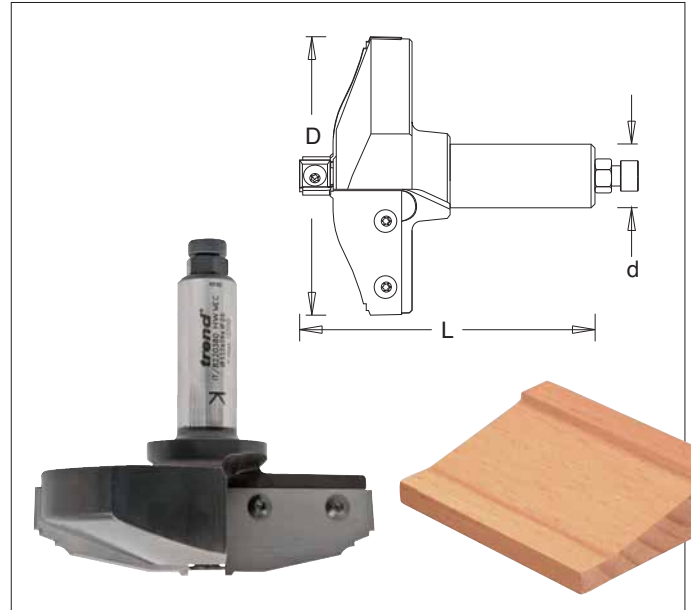

øD	Profile No.	L	ød	Product Ref.	Stock	Price
112	1	110	20	IT/822 031 0	Y	£175.09
112	2	110	20	IT/822 032 0	Y	£175.09
112	3	110	20	IT/822 033 0	N	£175.09
112	4	110	20	IT/822 034 0	Y	£175.09
112	5	110	20	IT/822 035 0	Y	£175.09
112	6	110	20	IT/822 036 0	N	£175.09
112	7	110	20	IT/822 037 0	Y	£175.09
112	8	110	20	IT/822 038 0	Y	£175.09

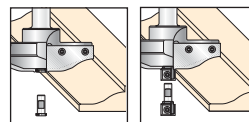

 Cutter can also be supplied with an 18mm diameter trimmer, Product Ref. IT/807 301 5.

TRIMMER BIT

A	øD	ød	B	L	Product Ref.	Stock	Price
90°	18	8	12	31.8	IT/807 301 5	Y	£59.46

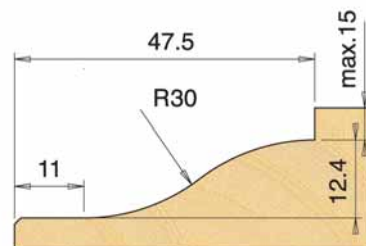

T.C. BLADES

PROFILE 1

Prod. Ref.	IT/352 220 1
Size	50x30.5x2
Price	£34.22

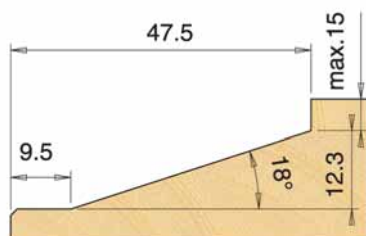

PROFILE 2

Prod. Ref.	IT/352 220 2
Size	50x30.5x2
Price	£34.22